

# IDX

## Firmware Specification



[idx.maxongroup.com](http://idx.maxongroup.com)

## TABLE OF CONTENTS

<b>1</b>	<b>ABOUT</b>	<b>7</b>
1.1	About this Document. . . . .	7
1.2	About the Devices. . . . .	11
1.3	About the Safety Precautions . . . . .	11
<b>2</b>	<b>SYSTEM OVERVIEW</b>	<b>13</b>
2.1	Device Architecture. . . . .	13
2.2	Device Control. . . . .	14
2.3	System Units. . . . .	17
2.4	USB Bus Powering . . . . .	18
<b>3</b>	<b>OPERATING MODES</b>	<b>19</b>
3.1	Operating Mode Selection Guide . . . . .	19
3.2	Overview . . . . .	20
3.3	Profile Position Mode (PPM). . . . .	21
3.4	Profile Velocity Mode (PVM). . . . .	25
3.5	Homing Mode (HMM) . . . . .	28
3.6	Cyclic Synchronous Position Mode (CSP) . . . . .	34
3.7	Cyclic Synchronous Velocity Mode (CSV) . . . . .	38
3.8	Cyclic Synchronous Torque Mode (CST) . . . . .	41
3.9	Position Control Function . . . . .	44
3.10	Velocity Control Function . . . . .	46
3.11	Current Control Function. . . . .	48

### READ THIS FIRST

***These instructions are intended for qualified technical personnel. Prior commencing with any activities...***

- you must carefully read and understand this manual and
- you must follow the instructions given therein.

***IDX drives are considered as partly completed machinery according to EU Directive 2006/42/EC, Article 2, Clause (g) and are intended to be incorporated into or assembled with other machinery or other partly completed machinery or equipment.***

***Therefore, you must not put the device into service,...***

- unless you have made completely sure that the other machinery fully complies with the EU directive's requirements!
- unless the other machinery fulfills all relevant health and safety aspects!
- unless all respective interfaces have been established and fulfill the herein stated requirements!

<b>4</b>	<b>INPUTS AND OUTPUTS</b>	<b>51</b>
4.1	Digital Inputs . . . . .	51
4.2	Digital Outputs . . . . .	52
4.3	Analog Inputs . . . . .	53
<b>5</b>	<b>COMMUNICATION</b>	<b>55</b>
5.1	USB Communication . . . . .	55
5.2	CAN Communication . . . . .	55
5.3	EtherCAT Communication . . . . .	55
5.4	Gateway Communication (USB to CAN) . . . . .	55
<b>6</b>	<b>OBJECT DICTIONARY</b>	<b>57</b>
6.1	Overview . . . . .	57
6.1.1	Object Data Types . . . . .	57
6.1.2	Object Codes . . . . .	57
6.1.3	Object Access Types . . . . .	57
6.1.4	Object Flags . . . . .	58
6.1.5	Entries Overview . . . . .	59
6.2	Objects . . . . .	63
6.2.1	Device type . . . . .	63
6.2.2	Error register . . . . .	63
6.2.3	Error history . . . . .	64
6.2.4	COB-ID SYNC . . . . .	65
6.2.5	Manufacturer device name . . . . .	65
6.2.6	Store parameters . . . . .	66
6.2.7	Restore default parameters . . . . .	67
6.2.8	COB-ID EMCY . . . . .	67
6.2.9	Consumer heartbeat time . . . . .	68
6.2.10	Producer heartbeat time . . . . .	69
6.2.11	Identity object . . . . .	69
6.2.12	Diagnosis History . . . . .	71
6.2.13	SDO server parameter . . . . .	75
6.2.14	Receive PDO 1 parameter . . . . .	76
6.2.15	Receive PDO 2 parameter . . . . .	78
6.2.16	Receive PDO 3 parameter . . . . .	79
6.2.17	Receive PDO 4 parameter . . . . .	80
6.2.18	Receive PDO 1 mapping . . . . .	81
6.2.19	Receive PDO 2 mapping . . . . .	83
6.2.20	Receive PDO 3 mapping . . . . .	85
6.2.21	Receive PDO 4 mapping . . . . .	87
6.2.22	Transmit PDO 1 parameter . . . . .	89
6.2.23	Transmit PDO 2 parameter . . . . .	91
6.2.24	Transmit PDO 3 parameter . . . . .	93
6.2.25	Transmit PDO 4 parameter . . . . .	95
6.2.26	Transmit PDO 1 mapping . . . . .	97

6.2.27	Transmit PDO 2 mapping	99
6.2.28	Transmit PDO 3 mapping	101
6.2.29	Transmit PDO 4 mapping	103
6.2.30	SYNC manager communication type	105
6.2.31	SYNC manager 2 PDO assignment	107
6.2.32	SYNC manager 3 PDO assignment	108
6.2.33	SYNC manager 2 parameter	109
6.2.34	SYNC manager 3 parameter	113
6.2.35	Program data	116
6.2.36	Program control	117
6.2.37	Program software identification	118
6.2.38	Flash status identification	119
6.2.39	Node-ID	121
6.2.40	CAN bit rate	122
6.2.41	USB frame timeout	122
6.2.42	CAN bit rate display	123
6.2.43	Active fieldbus	123
6.2.44	Active controller type	124
6.2.45	Additional identity	124
6.2.46	Extension 1 identity	125
6.2.47	Custom persistent memory	127
6.2.48	Power supply	128
6.2.49	Axis configuration	129
6.2.50	Motor data	134
6.2.51	Electrical system parameters	136
6.2.52	Gear configuration	137
6.2.53	SSI absolute encoder	139
6.2.54	Current control parameter set	147
6.2.55	Position control parameter set	148
6.2.56	Velocity control parameter set	150
6.2.57	Velocity observer parameter set	152
6.2.58	Home position	154
6.2.59	Home offset move distance	154
6.2.60	Current threshold for homing mode	155
6.2.61	Current demand value	155
6.2.62	Current actual values	156
6.2.63	Torque actual values	157
6.2.64	Velocity actual values	158
6.2.65	Standstill window configuration	159
6.2.66	Digital input properties	161
6.2.67	Configuration of digital inputs	162
6.2.68	Digital output properties	164
6.2.69	Configuration of digital outputs	165
6.2.70	Holding brake parameters	166
6.2.71	Analog input properties	168
6.2.72	Configuration of analog inputs	169
6.2.73	Analog input general purpose	170



6.2.74	Analog input adjustment	171
6.2.75	Analog input current set value properties	172
6.2.76	Analog input velocity set value properties	175
6.2.77	Motor protection	177
6.2.78	Thermal controller protection	178
6.2.79	Abort connection option code	179
6.2.80	Error code	179
6.2.81	Controlword	180
6.2.82	Statusword	181
6.2.83	Quick stop option code	182
6.2.84	Shutdown option code	182
6.2.85	Disable operation option code	183
6.2.86	Fault reaction option code	183
6.2.87	Modes of operation	184
6.2.88	Modes of operation display	184
6.2.89	Position demand value	185
6.2.90	Position actual value	185
6.2.91	Following error window	185
6.2.92	Following error timeout	186
6.2.93	Velocity demand value	186
6.2.94	Velocity actual value	186
6.2.95	Target torque	187
6.2.96	Motor rated torque	187
6.2.97	Torque actual value	187
6.2.98	Target position	188
6.2.99	Position range limit	189
6.2.100	Software position limit	190
6.2.101	Max profile velocity	191
6.2.102	Max motor speed	192
6.2.103	Profile velocity	192
6.2.104	Profile acceleration	193
6.2.105	Profile deceleration	193
6.2.106	Quick stop deceleration	193
6.2.107	Motion profile type	194
6.2.108	Homing method	194
6.2.109	Homing speeds	195
6.2.110	Homing acceleration	196
6.2.111	SI unit position	196
6.2.112	SI unit velocity	197
6.2.113	SI unit acceleration	198
6.2.114	Position offset	198
6.2.115	Velocity offset	199
6.2.116	Torque offset	199
6.2.117	Touch probe function	200
6.2.118	Touch probe status	201
6.2.119	Touch probe position 1 positive value	201
6.2.120	Touch probe position 1 negative value	202

6.2.121	Interpolation time period	203
6.2.122	Max acceleration	204
6.2.123	Touch probe source	205
6.2.124	Touch probe 1 positive edge counter	206
6.2.125	Touch probe 1 negative edge counter	206
6.2.126	Following error actual value	207
6.2.127	Digital inputs	208
6.2.128	Digital outputs	209
6.2.129	Target velocity	210
6.2.130	Motor type	210
6.2.131	Supported drive modes	211
6.2.132	Modular device profile	212
6.2.133	Configured module ident list	213
6.2.134	Detected module ident list	214
<b>6.3</b>	<b>Modular Device Profile Module</b>	<b>215</b>
6.3.1	MDP Module PPM	215
6.3.2	MDP Module PVM	216
6.3.3	MDP Module CSP	217
6.3.4	MDP Module CSV	218
6.3.5	MDP Module CST	219
<b>7</b>	<b>ERROR HANDLING</b>	<b>221</b>
7.1	Emergency Message Frame	221
7.2	Device Errors	221
7.3	CANopen Communication Errors (Abort Codes)	238
7.4	EtherCAT FoE Error Codes	239
<b>8</b>	<b>FIRMWARE VERSION HISTORY</b>	<b>241</b>
8.1	Version Overview	241
8.2	Version History	242

## 1 ABOUT

### 1.1 About this Document

#### 1.1.1 Intended Purpose

The purpose of the present document is to familiarize you with the described equipment and the tasks on safe and adequate installation and/or commissioning. Follow the described instructions ...

- to avoid dangerous situations,
- to keep installation and/or commissioning time at a minimum,
- to increase reliability and service life of the described equipment.

The present document is part of a documentation set and provides IDX firmware details and contains descriptions on architecture, device states, operation modes, error handling, and object dictionary. The below overview shows the documentation hierarchy and the interrelationship of its individual parts:

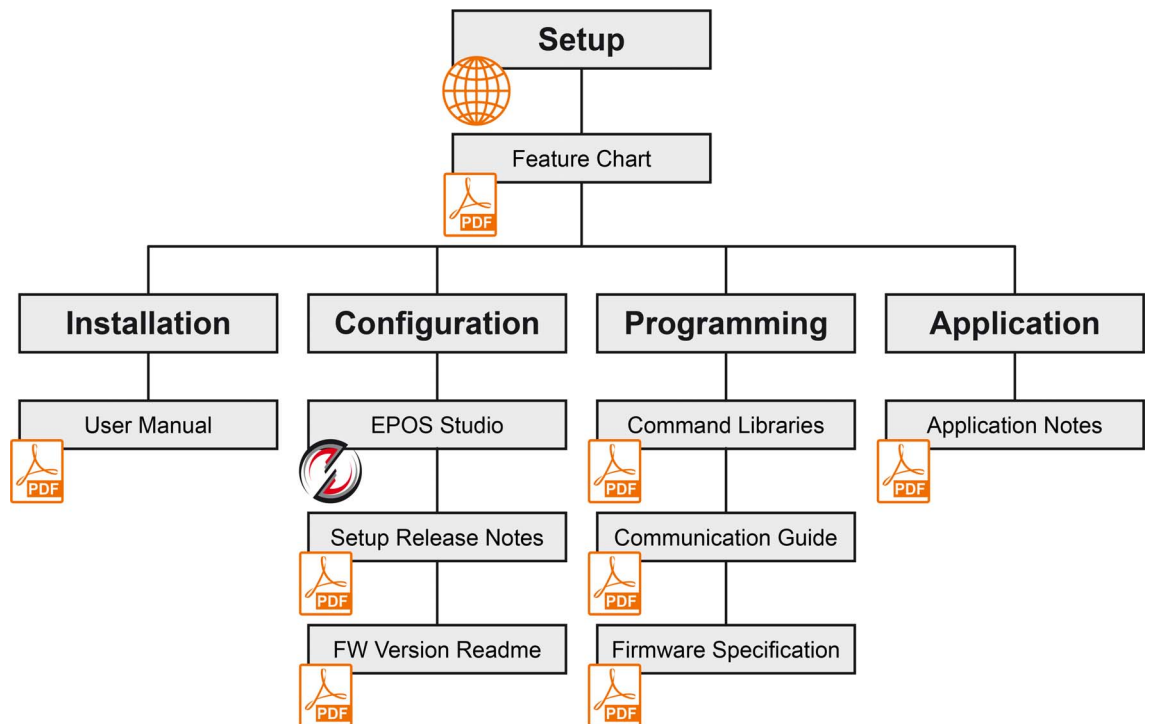

Figure 1-1 Documentation structure

Find the latest edition of the present document as well as additional documentation and software for IDX positioning controllers also on the Internet: → <http://idx.maxongroup.com>

#### 1.1.2 Target Audience

This document is meant for trained and skilled personnel working with the equipment described. It conveys information on how to understand and fulfill the respective work and duties.

This document is a reference book. It does require particular knowledge and expertise specific to the equipment described.

### 1.1.3 How to use

Take note of the following notations and codes which will be used throughout the document.

Notation	Explanation
EPOS4	stands for "EPOS4 positioning controller"
IDX	stands for "IDX drive"
«Abcd»	indicating a title or a name (such as of document, product, mode, etc.)
(n)	referring to an item (such as order number, list item, etc.)
*	referring to an internal value
→	denotes "see", "see also", "take note of", or "go to"

Table 1-1 Notations used

In the later course of the present document, the following abbreviations and acronyms will be used:

Short	Description
CCW	Counterclockwise
CiA	CAN in Automation
CSP	Cyclic Synchronous Position Mode
CST	Cyclic Synchronous Torque Mode
CSV	Cyclic Synchronous Velocity Mode
CW	Clockwise
GPIO	General purpose input/output
HMM	Homing Mode
NMT	Network Management
OBD	Object Dictionary
PDO	Process Data Object
PPM	Profile Position Mode
PVM	Profile Velocity Mode
SDO	Service Data Object

Table 1-2 Abbreviations & acronyms used

### 1.1.4 Symbols and Signs



#### **Requirement / Note / Remark**

*Indicates an action you must perform prior continuing or refers to information on a particular item.*



#### **Best Practice**

*Gives advice on the easiest and best way to proceed.*



#### **Material Damage**

*Points out information particular to potential damage of equipment.*

### 1.1.5 Trademarks and Brand Names

For easier legibility, registered brand names are listed below and will not be further tagged with their respective trademark. It must be understood that the brands (the below list is not necessarily concluding) are protected by copyright and/or other intellectual property rights even if their legal trademarks are omitted in the later course of this document.

Brand name	Trademark owner
Adobe® Reader®	© Adobe Systems Incorporated, USA-San Jose, CA
CANopen® CiA®	© CiA CAN in Automation e.V, DE-Nuremberg
EtherCAT®	© EtherCAT Technology Group, DE-Nuremberg, licensed by Beckhoff Automation GmbH, DE-Verl

Table 1-3 Brand names and trademark owners

### 1.1.6 Sources for additional Information

For further details and additional information, please refer to below listed sources:

#	Reference
[1]	USB Implementers Forum: Universal Serial Bus Revision 2.0 Specification <a href="http://www.usb.org/developers/docs">www.usb.org/developers/docs</a>
[2]	CiA 301 CANopen application layer and communication profile <a href="http://www.can-cia.org">www.can-cia.org</a>
[3]	CiA 306 CANopen electronic data sheet specification <a href="http://www.can-cia.org">www.can-cia.org</a>
[4]	CiA 402 CANopen device profile for drives and motion control <a href="http://www.can-cia.org">www.can-cia.org</a>
[5]	Bosch's CAN Specification 2.0 <a href="http://www.can-cia.org">www.can-cia.org</a>
[6]	Konrad Etschberger: Controller Area Network ISBN 3-446-21776-2
[7]	maxon: IDX Communication Guide <a href="http://www.maxongroup.com">www.maxongroup.com</a>
[8]	maxon: IDX Application Notes <a href="http://www.maxongroup.com">www.maxongroup.com</a>
[9]	IEC 61158-x-12: Industrial communication networks – Fieldbus specifications (CPF 12)
[10]	IEC 61800-7: Adjustable speed electrical power drives systems (Profile type 1)
[11]	ETG.1000 EtherCAT Specification <a href="http://www.ethercat.org">www.ethercat.org</a>
[12]	ETG.1020 EtherCAT Protocol Enhancements Specification <a href="http://www.ethercat.org">www.ethercat.org</a>
[13]	ETG.2000 EtherCAT Slave Information (ESI) Specification <a href="http://www.ethercat.org">www.ethercat.org</a>
[14]	EN 5325-4 Industrial communications subsystem based on ISO 11898 (CAN) for controller device interfaces Part4: CANopen

Table 1-4 Sources for additional information

### 1.1.7 Copyright

This document is protected by copyright. Any further use (including reproduction, translation, microfilming, and other means of electronic data processing) without prior written approval is not permitted. The mentioned trademarks belong to their respective owners and are protected under intellectual property rights. © 2019 maxon. All rights reserved. Subject to change without prior notice.

CCMC | IDX Firmware Specification | Edition 2019-11 | DocID rel9237

maxon motor ag  
Brünigstrasse 220 +41 41 666 15 00  
CH-6072 Sachseln [www.maxongroup.com](http://www.maxongroup.com)

## 1.2 About the Devices

maxon's «IDX» are compact, high-performance, IP 65-protected, brushless DC drives with either integrated positioning controller or speed controller particularly suitable for the use in harsh environmental conditions. They deliver up to 0.7 Nm of continuous torque and come in a wide range of configurable options that allow full adaptation to suit specific needs.

The IDX firmware is based on maxon's EPOS4 platform.

## 1.3 About the Safety Precautions

### IMPORTANT NOTICE: PREREQUISITES FOR PERMISSION TO COMMENCE INSTALLATION

**IDX drives** are considered as partly completed machinery according to EU Directive 2006/42/EC, Article 2, Clause (g) and **are intended to be incorporated into or assembled with other machinery or other partly completed machinery or equipment.**



#### WARNING

##### ***Risk of Injury***

***Operating the device without the full compliance of the surrounding system with the EU directive 2006/42/EC may cause serious injuries!***

- *Do not operate the device, unless you have made sure that the other machinery fulfills the requirements stated in EU directive!*
- *Do not operate the device, unless the surrounding system fulfills all relevant health and safety aspects!*
- *Do not operate the device, unless all respective interfaces have been established and fulfill the stated requirements!*

**••page intentionally left blank••**



## 2 SYSTEM OVERVIEW

### 2.1 Device Architecture

The IDX's communication interface follows these specifications (numbers in brackets refer to respective items listed on →page 1-10):

- CiA 301 V4.2; CANopen application layer and communication profile (→[2]), corresponds with the international standard EN 5325-4; Industrial communications subsystem based on ISO 11898 (CAN) (→[14])
- CiA 306 V1.3; CANopen electronic data sheet specification (→[3])
- CiA 402 V4.0; CANopen device profile for drives and motion control (→[4]), corresponds with international standard IEC 61800-7 Ed 2.0; Generic interface and use of profiles for power drive systems – profile type 1 (→[10])
- ETG.1000 V1.0.4; EtherCAT Specification (→[11]), corresponds with the international standard IEC 61158-x-12; Industrial communication networks – Fieldbus specifications (CPF 12: EtherCAT) (→[9])
- ETG.1020 V1.2.0; EtherCAT Protocol Enhancements Specification (→[12])
- ETG.2000 V1.0.9; EtherCAT Slave Information (ESI) Specification (→[13])

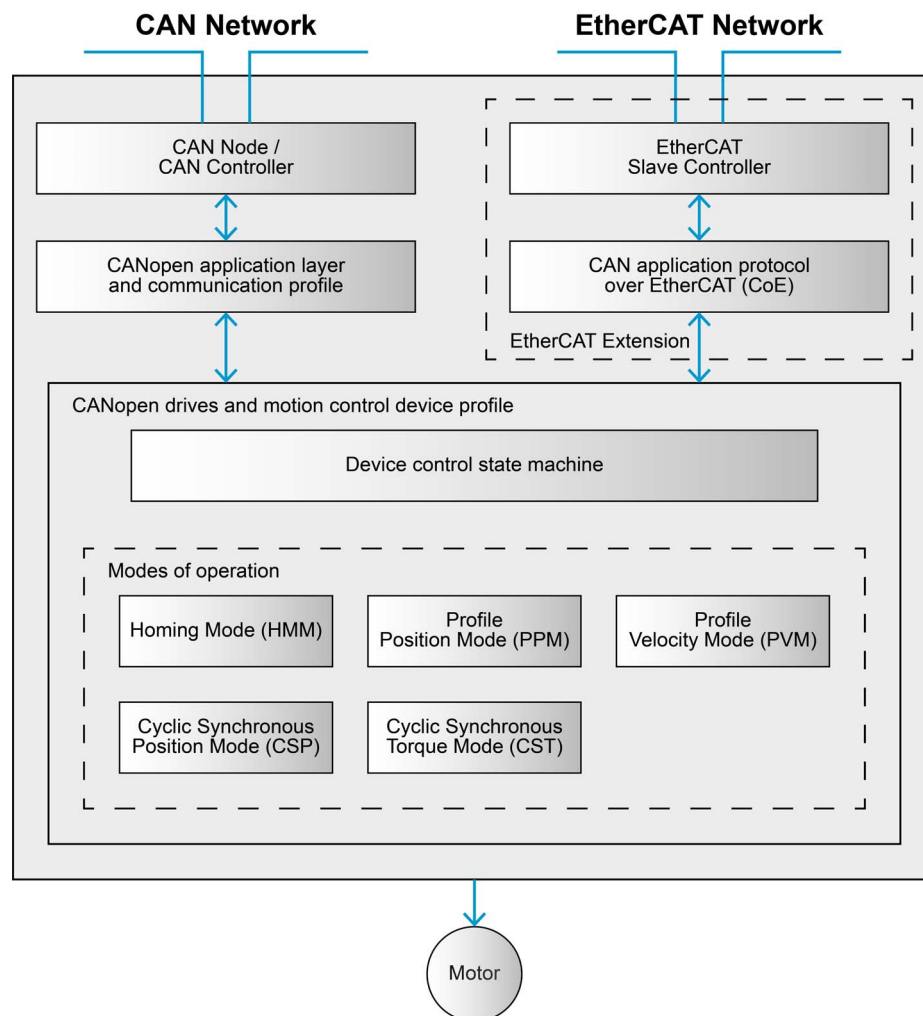

Figure 2-2 Communication architecture

**DEVICE CONTROL**

Starting and stopping of the drive and several mode-specific commands are executed by the state machine.

**MODES OF OPERATION**

The operating mode defines the behavior of the drive.

**2.2 Device Control**

The state machine describes the axis state and the possible control sequence of the axis. An axis state represents a special internal or external behavior. The state of the axis also determines the commands that will be accepted.

States may be changed using the →Controlword and/or according to internal events. The actual state can be read using the →Statusword. A new state transition must not be initiated before the previous one is completed and the →Statusword is changed accordingly.

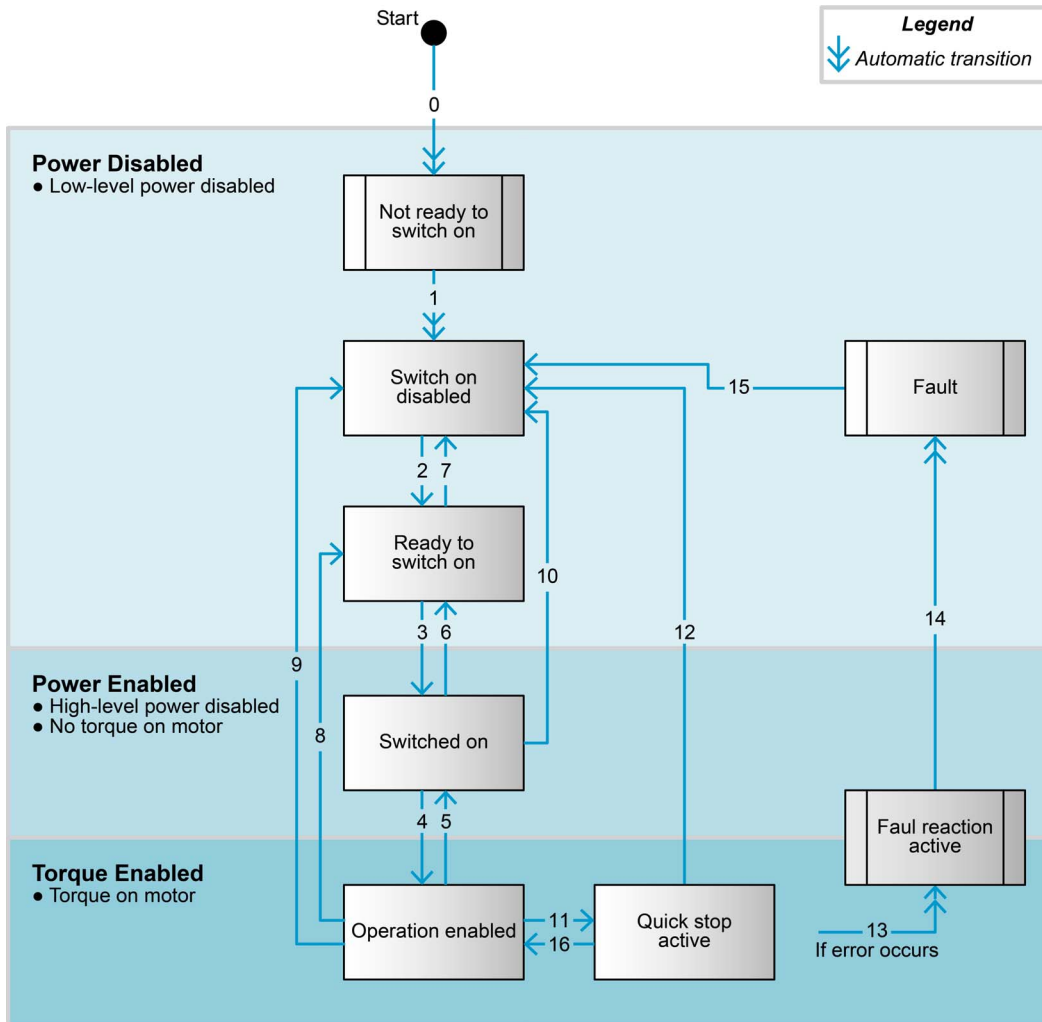

Figure 2-3 Device State Machine

## 2.2.1 State of the Drive

The following →Statusword bits indicate the actual state of the drive.

State	Statusword [binary]	Description
Not ready to switch on	xxxx xxxx x00x 0000	Drive function is disabled
Switch on disabled	xxxx xxxx x10x 0000	Drive initialization is complete. Drive parameters may be changed. Drive function is disabled.
Ready to switch on	xxxx xxxx x01x 0001	Drive parameters may be changed. Drive function is disabled.
Switched on	xxxx xxxx x01x 0011	Drive function is disabled. Current offset calibration done.
Operation enabled	xxxx xxxx x01x 0111	No faults have been detected. Drive function is enabled and power is applied to the motor.
Quick stop active	xxxx xxxx x00x 0111	«Quick stop» function is being executed. Drive function is enabled and power is applied to the motor.
Fault reaction active	xxxx xxxx x00x 1111	A fault has occurred in the drive. Selected fault reaction is being executed.
Fault	xxxx xxxx x00x 1000	A fault has occurred in the drive. Drive parameters may have changed. Drive function is disabled.

Table 2-5 Device state bits

## 2.2.2 State Transitions

State transitions are caused by internal events in the drive or by commands from the host via the →Controlword.



### State transition during change of state

*If a command is received which causes a change of state, this command will be processed completely and the new state attained before the next command can be processed.*

Transition	Event	Action
0	Reset	Initialize drive
1	Drive has initialized successfully	Activate communication
2	«Shutdown» command received	
3	«Switched on» command received	Initialize current sensor. Current offset calibration.
4	«Enable operation» command received	Enable drive function (enable current controller and, if needed, position or velocity controller)
5	«Disable operation» command received	Stop movement according to «Disable operation option code». Disable drive function.
6	«Shutdown» command received	Disable power section
7	«Quick stop» or «Disable voltage» command received	

Continued on next page.

Transition	Event	Action
8	«Shutdown» command received	Stop movement according to «Shutdown option code». Disable drive function and power section.
9	«Disable voltage» command received	Stop movement according to «Shutdown option code». Disable drive function and power section.
10	«Quick stop» or «Disable voltage» command received	
11	«Quick stop» command received	Stop movement according to «Quick stop option code»
12	«Disable voltage» command received	Disable drive function and power section
13	A fault has occurred	Start fault reaction
14	The fault reaction is completed	Disable drive function and power section
15	«Fault reset» command received	Reset fault condition if no fault is present
16	«Enable operation» command received	

Table 2-6 Device state transitions

### 2.2.3 Device Control Commands

Axis control commands are triggered by the following bit patterns in the →Controlword.

Command	Controlword LowByte [binary]	State transition
Shutdown	0xxx x110	2, 6, 8
Switch on	0xxx x111	3
Switch on & Enable operation	0xxx 1111	3, 4 (*1)
Disable voltage	0xxx xx0x	7, 9, 10, 12
Quick stop	0xxx x01x	11
Disable operation	0xxx 0111	5
Enable operation	0xxx 1111	4, 16
Fault reset	0xxx xxxx → 1xxx xxxx	14, 15

(\*1) Automatic transition to state «Operation enabled» after execution of command «Switch on»

Table 2-7 Axis control commands

## 2.3 System Units

The user-defined units for this device are as follows:

- Position Units (→“SI unit position” on page 6-196)
- Velocity Units (→“SI unit velocity” on page 6-197)
- Acceleration Units (→“SI unit acceleration” on page 6-198)

The units are used for all objects that support user-defined units. They are specified by the SI unit objects. Objects with factor group-independent values have fixed units specified by the object.

Coding of user-defined units and prefixes takes place as to →Table 2-8.

Bit 31...24	Bit 23...16	Bit 15...8	Bit 7...0
Prefix	Numerator	Denominator	reserved (0)

Table 2-8 User-defined units – Parameter structure

### 2.3.1 SI Units

Description	Name	Symbol	Notation index
Dimensionless	–	–	0x00
Length	Meter	m	0x01
Mass	Kilogram	kg	0x02
Time	Second	s	0x03
Electric current	Ampere	A	0x04
Time	Minute	min	0x47
Square second	Square second	s <sup>2</sup>	0x57

Table 2-9 SI units – Notation index

### 2.3.2 CiA 402 Application Profile-specific Units

Description	Name	Symbol	Notation index
Revolutions	revolutions	rev	0xB4
Increments	increments	inc	0xB5
Steps	steps	steps	0xAC

Table 2-10 CiA 402 Application profile-specific units – Notation index

### 2.3.3 Unit Prefixes

Prefix	Factor	Symbol	Notation index
Mega	$10^6$	M	0x06
Kilo	$10^3$	k	0x03
Hecta	$10^2$	h	0x02
Deca	$10^1$	da	0x01
–	$10^0$	–	0x00
Deci	$10^{-1}$	d	0xFF
Centi	$10^{-2}$	c	0xFE
Milli	$10^{-3}$	m	0xFD
—	$10^{-4}$	—	0xFC
—	$10^{-5}$	—	0xFB
Micro	$10^{-6}$	$\mu$	0xFA

Table 2-11 Unit prefixes – Notation index

## 2.4 USB Bus Powering

Powering the controller for configuration via USB only is not possible. To use a communication interface, either the power supply or the logic supply must be connected.

### 3 OPERATING MODES

#### 3.1 Operating Mode Selection Guide

The device behavior depends on the currently activated mode of operation.

- Choose desired mode (→“Overview” on page 3-20).
- Select mode using (→“Modes of operation” on page 6-184).
- Read currently active mode from →“Modes of operation display” on page 6-184.

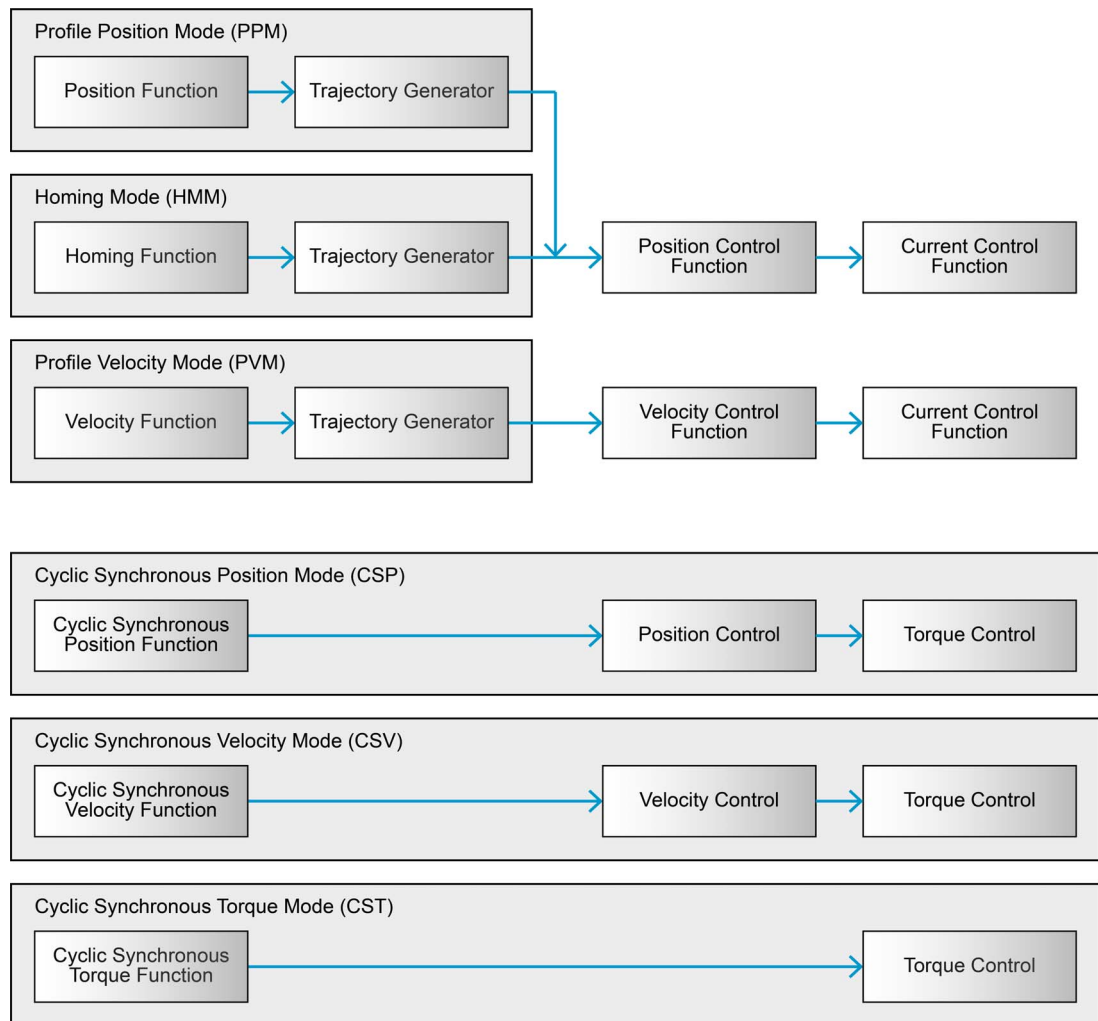

Figure 3-4 Functional architecture

## 3.2 Overview

### **PROFILE POSITION MODE (PPM)**

Defines the drive's positioning. Speed, position, and acceleration can be limited, profiled moves can be executed using a Trajectory Generator.

For details →page 3-21.

### **PROFILE VELOCITY MODE (PVM)**

Controls the drive's velocity without particular focus on the position. It supplies limit functions and Trajectory Generation.

For details →page 3-25.

### **HOMING MODE (HMM)**

Provides various methods to find the home position (also called reference point or zero point).

For details →page 3-28.

### **CYCLIC SYNCHRONOUS POSITION MODE (CSP)**

The trajectory generator is located in the control device (not in the drive device). In cyclic synchronous manner, it provides a target position to the drive device, which then performs position control, velocity control, and torque control.

For details →page 3-34

### **CYCLIC SYNCHRONOUS VELOCITY MODE (CSV)**

The trajectory generator is located in the control device (not in the drive device). In cyclic synchronous manner, it provides a target velocity to the drive device, which then performs velocity control and torque control.

For details →page 3-38

### **CYCLIC SYNCHRONOUS TORQUE MODE (CST)**

The trajectory generator is located in the control device (not in the drive device). In cyclic synchronous manner, it provides a target torque to the drive device, which then performs torque control.

For details →page 3-41.



## 3.3 Profile Position Mode (PPM)

**THE OPERATING MODE IS ONLY AVAILABLE FOR «IDX CANOPEN» AND «IDX ETHERCAT».**

A target position is applied to the trajectory generator. It will generate a position demand value for the position control function.



### Annotation

Items marked with an asterisk (\*) refer to internal values.

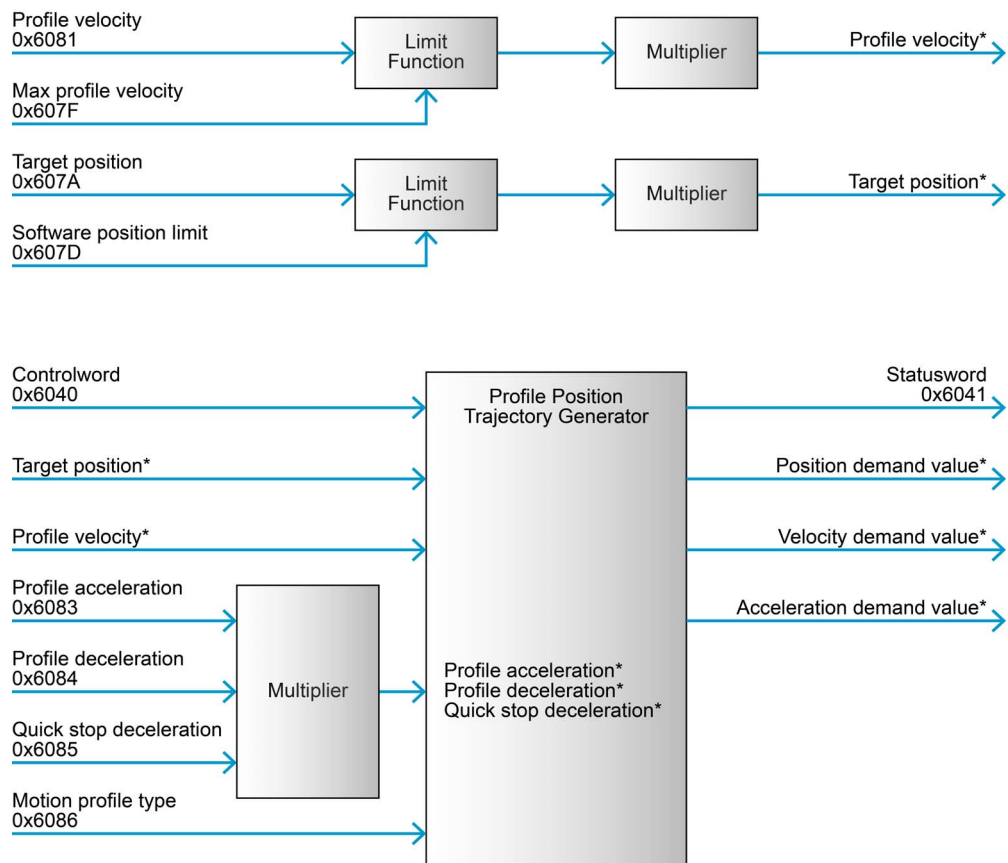

Figure 3-5 Profile Position Mode – Block diagram

### 3.3.1 Profile Position Trajectory Generator

The trajectory generator supports the following motion profiles.

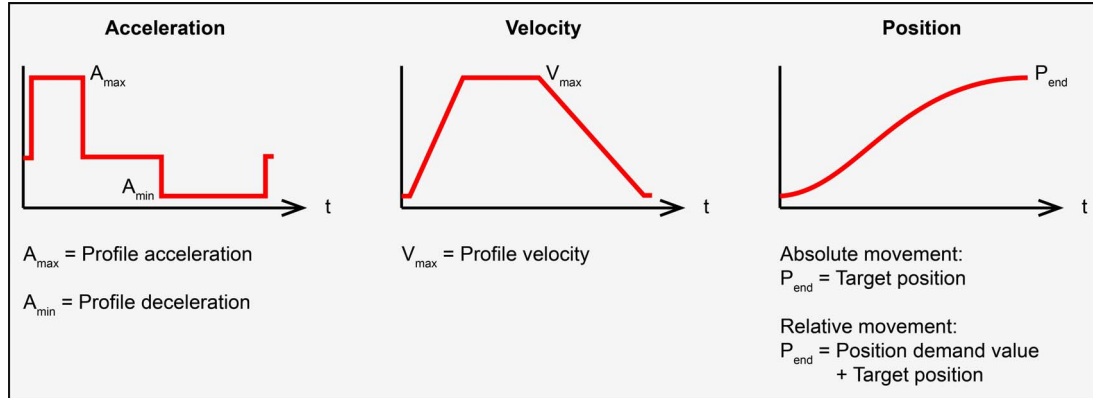

Figure 3-6 Profile position trajectory

### 3.3.2 How to use «PPM»

#### CONFIGURATION PARAMETERS

Parameter	Index	Description
→ Software position limit	0x607D	Contains the sub-parameters “Min position limit” and “Max position limit” that define the absolute position limits of the position demand value and position actual value. A new target position will be checked against these limits.
→ Max profile velocity	0x607F	Defines the maximal permitted speed
→ Max motor speed	0x6080	Indicates the configured maximal permitted speed for the motor. It serves as protection of the motor and is taken from the motor data sheet.
→ Max gear input speed	0x3003	Indicates the configured maximal permitted input speed of the gear. It serves as protection of the gear and is taken from the gear data sheet. Together with “Max motor speed”, it limits the speed of the system.
→ Quick stop deceleration	0x6085	Defines the deceleration ramp during a «Quick stop»
→ Max acceleration	0x60C5	Defines the maximal allowed acceleration and deceleration

Table 3-12 Profile Position Mode – Configuration parameters

## COMMANDING PARAMETERS

Parameter	Index	Description
→Controlword	0x6040	The mode will be controlled by a write access to the controlword's mode-dependent bits
→Target position	0x607A	The position to which the drive is supposed to move using the motion control parameters, such as velocity, acceleration, motion profile type, etc. It will be interpreted as absolute or relative depending on the controlword "abs / rel" flag.
→Profile velocity	0x6081	The velocity normally attained at the end of the acceleration ramp during a profiled move
→Profile acceleration	0x6083	Defines the acceleration ramp during a movement
→Profile deceleration	0x6084	Defines the deceleration ramp during a movement
→Motion profile type	0x6086	Selects the type of motion profile used for the movement: 0 = linear ramp (trapezoidal profile)

Table 3-13 Profile Position Mode – Commanding parameters

## CONTROLWORD (PROFILE POSITION MODE-SPECIFIC BITS)

To perform system endless movements, the "endless movement" bit can be set. Speed is given by →"Profile velocity" on page 6-192 while direction is given by the sign of →"Target position" on page 6-188.

Bit 15	Bit 14...9	Bit 8	Bit 7	Bit 6	Bit 5	Bit 4	Bit 3...0
Endless movement	→Table 6-116	Halt	→Table 6-116	Abs / rel	Change set immediately	New setpoint	→Table 6-116

Table 3-14 Profile Position Mode – Controlword

Name	Value	Description
New setpoint	0	Does not assume →Target position
	0→1	Assume →Target position
Change set immediately	0	Finish actual positioning, then start next positioning. The actual positioning is considered as completed as soon as the position demand value reaches the target position.
	1	Abort actual positioning and start next positioning
Abs / rel	0	→Target position is an absolute value
	1	→Target position is a relative value
Halt	0	Execute or continue positioning
	1	Stop axis with →Profile deceleration
Endless movement	0	Normal operation mode
	1	System will perform endless movement

Table 3-15 Profile Position Mode – Controlword bits

## OUTPUT PARAMETERS

Parameter	Index	Description
→Statusword	0x6041	Mode state can be observed by the statusword bits
→Position demand value	0x6062	The output of the trajectory generator. It is used as input for the position control function.

Table 3-16 Profile Position Mode – Output parameters

**STATUSWORD (PROFILE POSITION MODE-SPECIFIC BITS)**

Bit 15, 14	Bit 13	Bit 12	Bit 11	Bit 10	Bit 9...0
→Table 6-117	Following error	Setpoint acknowledge	→Table 6-117	Target reached	→Table 6-117

Table 3-17 Profile Position Mode – Statusword

Name	Value	Description
Target reached	0	Halt = 0: →Target position not reached Halt = 1: Axis decelerates
	1	Halt = 0: →Target position reached Halt = 1: Velocity of axis is "0" (zero)
Setpoint acknowledge	0	Positioning to the previous setpoint is ongoing and a new setpoint may be accepted
	1	The previous setpoint has been assumed and no additional setpoint may be accepted
Following error	0	Not following error
	1	Following error

Table 3-18 Profile Position Mode – Statusword bits

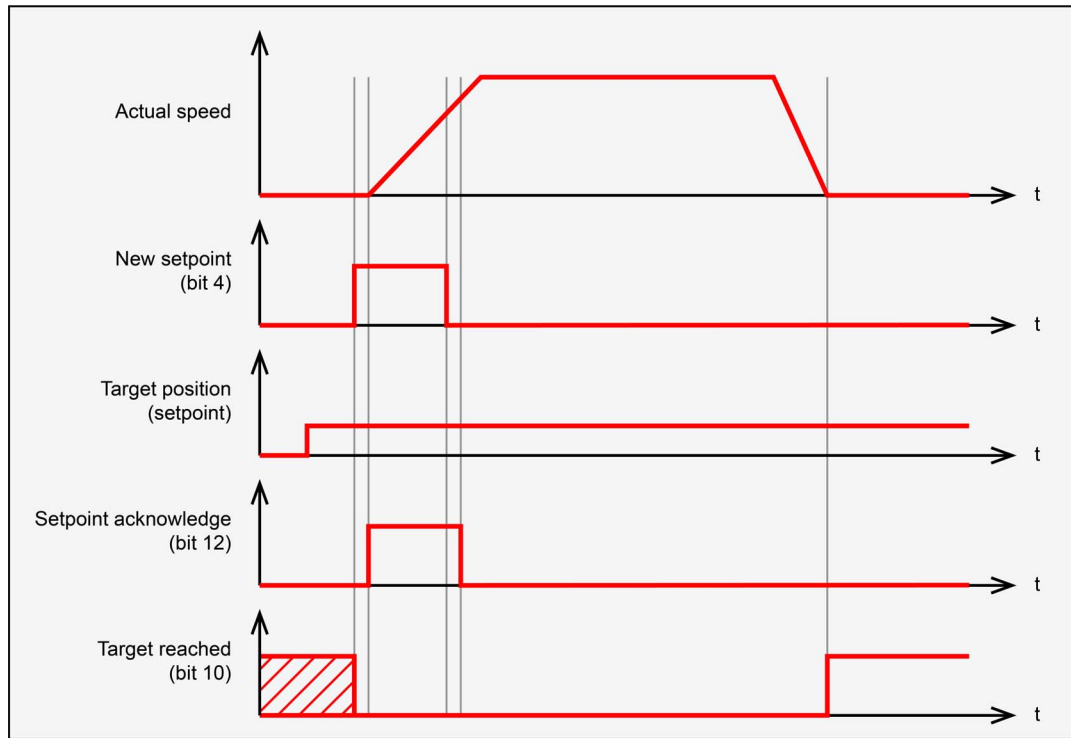

Figure 3-7 Profile Position Mode – Setpoint example

### 3.4 Profile Velocity Mode (PVM)

**THE OPERATING MODE IS ONLY AVAILABLE FOR «IDX CANOPEN» AND «IDX ETHERCAT».**

The profile velocity mode includes a velocity trajectory generator and a velocity control function.



**Annotation**

Items marked with an asterisk (\*) refer to internal values.

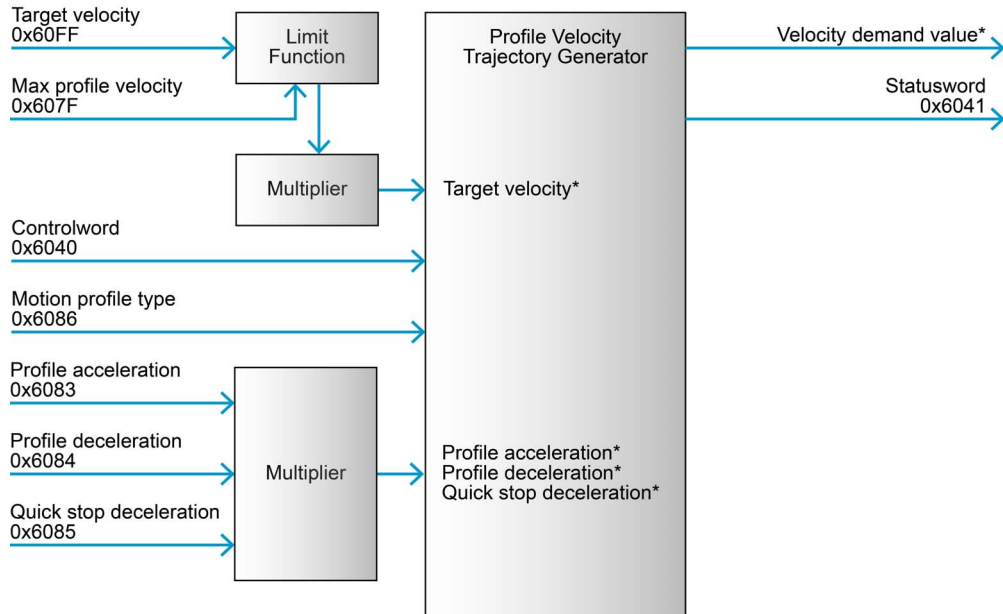

Figure 3-8 Profile Velocity Mode – Block diagram

#### 3.4.1 Profile Velocity Trajectory Generator

The trajectory generator supports the following motion profiles.

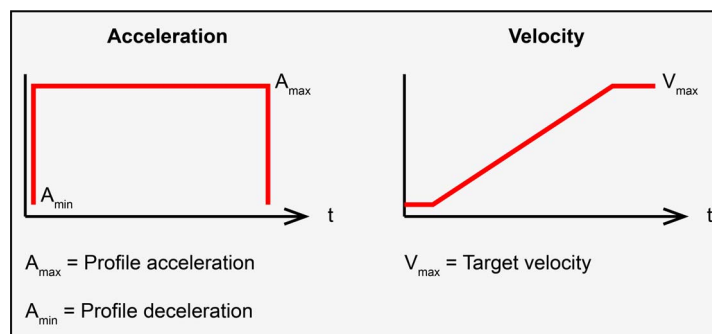

Figure 3-9 Profile velocity trajectory – Linear ramp (trapezoidal profile)

### 3.4.2 How to use «PVM»

#### CONFIGURATION PARAMETERS

Parameter	Index	Description
→ Software position limit	0x607D	Contains the sub-parameters “Min position limit” and “Max position limit” that define the absolute position limits of the position demand value and position actual value. A new target position will be checked against these limits.
→ Max profile velocity	0x607F	Defines the maximal permitted speed
→ Max motor speed	0x6080	Indicates the configured maximal permitted speed for the motor. It serves as protection of the motor and is taken from the motor data sheet.
→ Max gear input speed	0x3003	Indicates the configured maximal permitted input speed of the gear. It serves as protection of the gear and is taken from the gear data sheet. Together with “Max motor speed”, it limits the speed of the system.
→ Quick stop deceleration	0x6085	Defines the deceleration ramp during a «Quick stop»
→ Max acceleration	0x60C5	Defines the maximal allowed acceleration and deceleration

Table 3-19 Profile Velocity Mode – Configuration parameters

#### COMMANDING PARAMETERS

Parameter	Index	Description
→ Controlword	0x6040	The mode will be controlled by a write access to the controlword’s mode-dependent bits. A new target velocity is not assumed before the controlword is written.
→ Target velocity	0x60FF	The speed that the drive is supposed to reach
→ Profile acceleration	0x6083	Defines the acceleration ramp during a movement
→ Profile deceleration	0x6084	Defines the deceleration ramp during a movement
→ Motion profile type	0x6086	Selects the type of motion profile used for the movement: 0 = linear ramp (trapezoidal profile)

Table 3-20 Profile Velocity Mode – Commanding parameters

#### CONTROLWORD (PROFILE VELOCITY MODE-SPECIFIC BITS)

Bit 15...9	Bit 8	Bit 7	Bit 6...4	Bit 3...0
→ Table 6-116	Halt	→ Table 6-116	reserved	→ Table 6-116

Table 3-21 Profile Velocity Mode – Controlword

Name	Value	Description
Halt	0	Execute or continue motion
	1	Stop axis

Table 3-22 Profile Velocity Mode – Controlword bits

## OUTPUT PARAMETERS

Parameter	Index	Description
→ Statusword	0x6041	Mode state can be observed by the statusword bits
→ Velocity demand value	0x606B	The output of the trajectory generator. It is used as input for the velocity control function.

Table 3-23 Profile Velocity Mode – Output parameters

## STATUSWORD (PROFILE VELOCITY MODE-SPECIFIC BITS)

Bit 15, 14	Bit 13	Bit 12	Bit 11 (*2)	Bit 10	Bit 9...0
→ Table 6-117	Not used	Speed	Speed is limited	Target reached	→ Table 6-117

(\*2) Bit 11 is shared with I2t current limitation feature

Table 3-24 Profile Velocity Mode – Statusword

Name	Value	Description
Target reached	0	Halt = 0: Target velocity not (yet) reached Halt = 1: Axis decelerates
	1	Halt = 0: Target velocity reached Halt = 1: Axis has velocity "0" (zero)
Speed	0	Speed is not equal "0" (zero)
	1	Speed is equal "0" (zero)
Speed is limited	0	Speed is not limited
	1	Speed is limited to → Max profile velocity

Table 3-25 Profile Velocity Mode – Statusword bits

### 3.5 Homing Mode (HMM)

**THE OPERATING MODE IS ONLY AVAILABLE FOR «IDX CANOPEN» AND «IDX ETHERCAT».**

«Homing» describes the procedure according to which the drive seeks the home position (also called reference point or zero point). There are various methods to achieve this using limit switches at both ends of travel.



**Annotation**

Items marked with an asterisk (\*) refer to internal values.

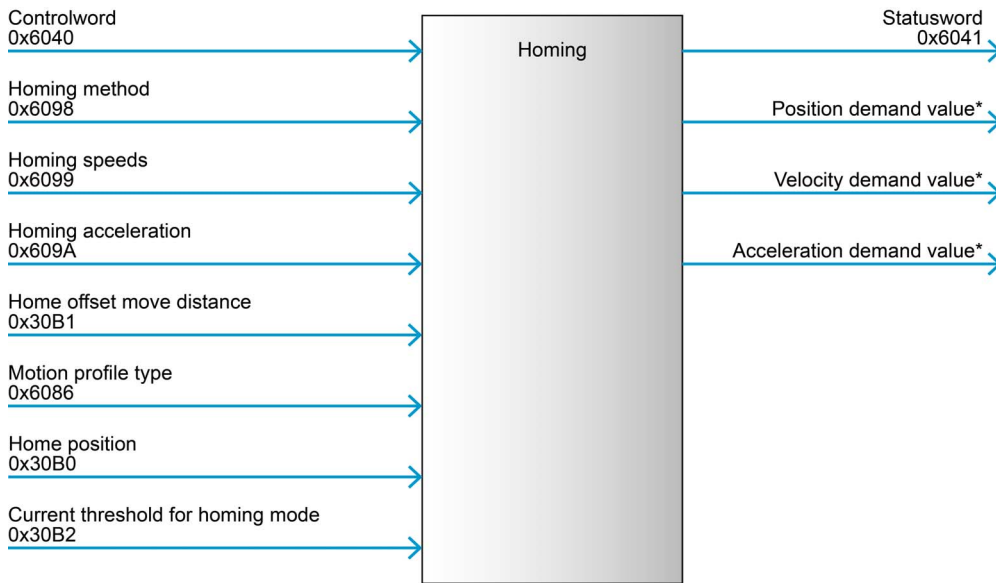

Figure 3-10 Homing Mode – Block diagram

#### 3.5.1 Homing Trajectory Generator

The trajectory generator supports the following motion profiles. The movements are mode-dependent, the end positions will be calculated internally.

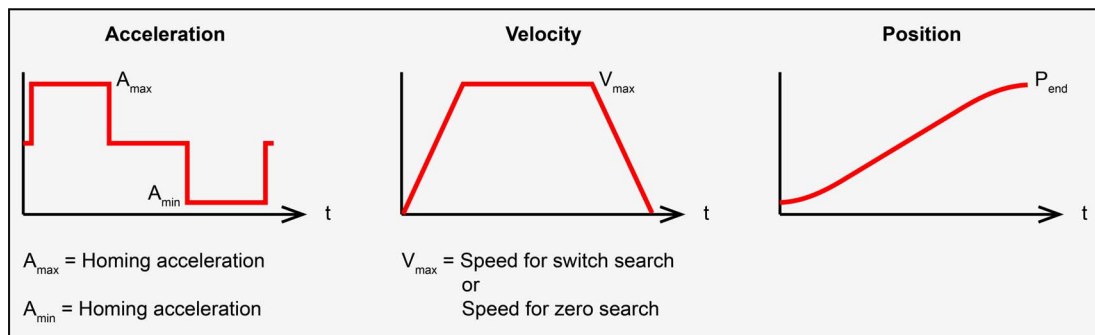

Figure 3-11 Homing trajectory – Linear ramp (trapezoidal profile)



### 3.5.2 How to use «HMM»

#### CONFIGURATION PARAMETERS

Parameter	Index	Description
→ Digital input properties	0x3141	Input polarity and logic state
→ Configuration of digital inputs	0x3142	Permits the configuration of digital inputs to digital input functionalities. Necessary for limit and homing switches that are used for «Homing».
→ Digital inputs	0x3141	Input functionality state (after polarity correction)
→ Motion profile type	0x6086	Selects the type of motion profile used for the movement: 0 = linear ramp (trapezoidal profile)

Table 3-26 Homing Mode – Configuration parameters

#### COMMANDING PARAMETERS

Parameter	Index	Description
→ Controlword	0x6040	The mode will be controlled by a write access to the controlword's mode-dependent bits
→ Homing method	0x6098	Defines the type of homing procedure
→ Homing speeds	0x6099	Specifies the two speeds used for Homing: In a typical cycle, the faster speed is used to find the home switch and for the offset move, the slower speed is used to find the index pulse.
→ Homing acceleration	0x609A	Specifies the acceleration during Homing
→ Home offset move distance	0x30B1	The distance to move away from a detected position upon end of the homing sequence
→ Home position	0x30B0	Allows to displace zero in the user's coordinate system
→ Current threshold for homing mode	0x30B2	The current threshold for current index homing methods

Table 3-27 Homing Mode – Commanding parameters

#### CONTROLWORD (HOMING MODE-SPECIFIC BITS)

Bit 15...9	Bit 8	Bit 7	Bit 6, 5	Bit 4	Bit 3...0
→ Table 6-116	Halt	→ Table 6-116	reserved	Homing operation start	→ Table 6-116

Table 3-28 Homing Mode – Controlword

Name	Value	Description
Homing operation start	0	Do not start homing procedure
	0→1	Start or continue homing procedure
Halt	0	Execute instruction of bit 4
	1	Stop axis with → Homing acceleration

Table 3-29 Homing Mode – Controlword bits

### OUTPUT PARAMETERS

Parameter	Index	Description
→ Statusword	0x6041	Mode state can be observed by the statusword bits

Table 3-30 Homing Mode – Output parameters

### STATUSWORD (HOMING MODE-SPECIFIC BITS)

Bit 15	Bit 14	Bit 13	Bit 12	Bit 11	Bit 10	Bit 9...0
Position referenced to home position	→ Table 6-117	Homing error	Homing attained	→ Table 6-117	Target reached	→ Table 6-117

Table 3-31 Homing Mode – Statusword

Name	Value	Description
Bit 15 Position referenced to home position	0	The position is not referenced to the home position (for example homing not yet attained or position overflow)
	1	Homing was attained and the position is referenced to the home position

Table 3-32 Homing Mode – Statusword bit 15

Bit 13 Homing error	Bit 12 Homing attained	Bit 10 Target reached	Description
0	0	0	Homing procedure is in progress
0	0	1	Homing procedure is interrupted or not started
0	1	X	Homing procedure is completed successfully
1	0	X	Homing error occurred

Table 3-33 Homing Mode – Statusword bits 10, 12, and 13

**3.5.3 Homing Methods**

**3.5.3.1 Homing Method 17 (Negative Limit Switch)**

The initial direction of the movement is negative (here to the left) if the negative limit switch is inactive (here shown as low).

- a) The axis moves with →Speed for switch search to the positive edge of the limit switch and with →Speed for zero search to the negative edge of the limit switch (1).
- b) The axis moves the →Home offset move distance (2) in positive direction with Speed for switch search. This point will be used as reference for all further moves and is set to →Home position (3).

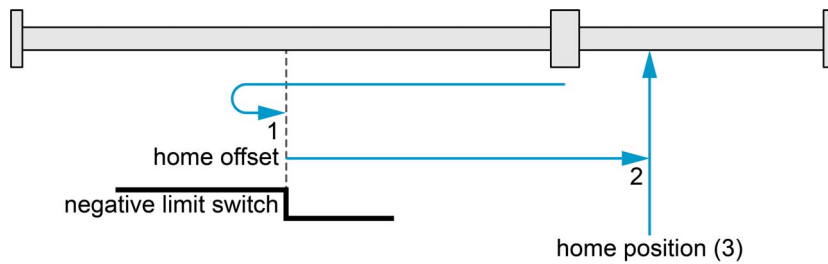

Figure 3-12 Homing method 17

**3.5.3.2 Homing Method 18 (Positive Limit Switch)**

The initial direction of the movement is positive (here to the right) if the positive limit switch is inactive (here shown as low).

- a) The axis moves with →Speed for switch search to the positive edge of the limit switch and with →Speed for zero search to the negative edge of the limit switch (1).
- b) The axis moves the →Home offset move distance (2) in negative direction with →Speed for switch search. This point will be used as reference for all further moves and is set to →Home position (3).

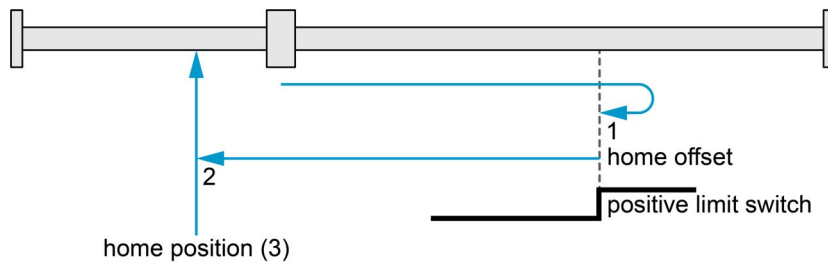

Figure 3-13 Homing method 18

### 3.5.3.3 Homing Method 23 (Home Switch Positive Speed)

The method uses a home switch, which is active only during part of the movement. In effect, the switch acts as the position of the axis sweeps past the switch.

The initial direction of the movement is positive (here to the right) except when the home switch is already active upon start of the movement.

- a) The axis moves with →Speed for switch search to the positive edge of the limit switch (1).
- b) The axis moves the →Home offset move distance (2) with →Speed for switch search. This point will be used as reference for all further moves and is set to →Home position (3).

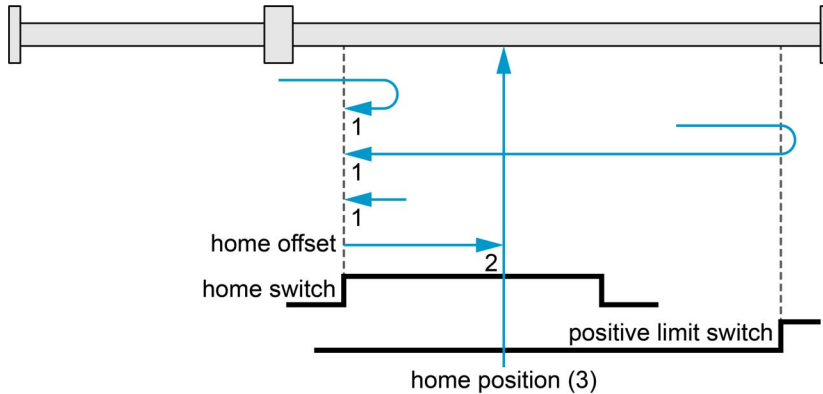

Figure 3-14 Homing method 23

### 3.5.3.4 Homing Method 27 (Home Switch Negative Speed)

The method uses a home switch, which is active only during part of the movement. In effect, the switch acts as the position of the axis sweeps past the switch.

The initial direction of the movement is negative (here to the left) except when the home switch is already active upon start of the movement.

- a) The axis moves with →Speed for switch search to the positive edge of the limit switch (1).
- b) The axis moves the →Home offset move distance (2) with →Speed for switch search. This point will be used as reference for all further moves and is set to →Home position (3).

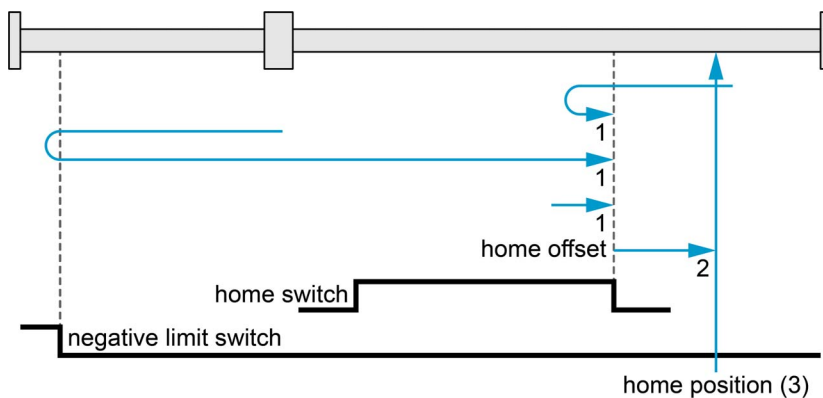

Figure 3-15 Homing method 27

**3.5.3.5 Homing Method 37 (Actual Position)**

The actual position is changed and considered as the future →Home position. The method may be used if the axis is disabled.

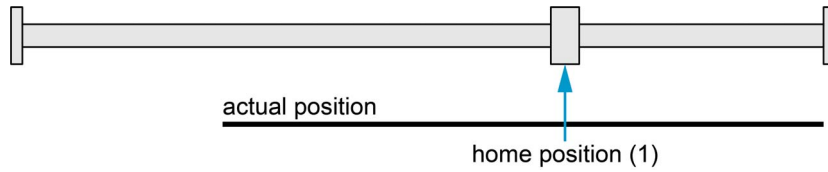

Figure 3-16 Homing method 37

**3.5.3.6 Homing Method -3 (Current Threshold Positive Speed)**

The method uses a mechanical end stop on the right (positive) side. The edge is detected when the averaged output current rises above →Current threshold for homing mode.

- a) The axis moves with →Speed for switch search to the mechanical end stop (1).
- b) The axis moves the →Home offset move distance (2) with →Speed for switch search. This point will be used as reference for all further moves and is set to →Home position (3).

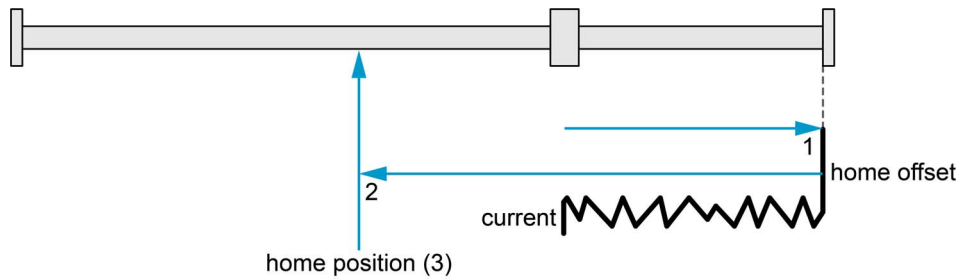

Figure 3-17 Homing method -3

**3.5.3.7 Homing Method -4 (Current Threshold Negative Speed)**

The method uses a mechanical end stop on the left (negative) side. The edge is detected when the averaged output current rises above →Current threshold for homing mode.

- a) The axis moves with →Speed for switch search to the mechanical end stop (1).
- b) The axis moves the →Home offset move distance (2) with →Speed for switch search. This point will be used as reference for all further moves and is set to →Home position (3).

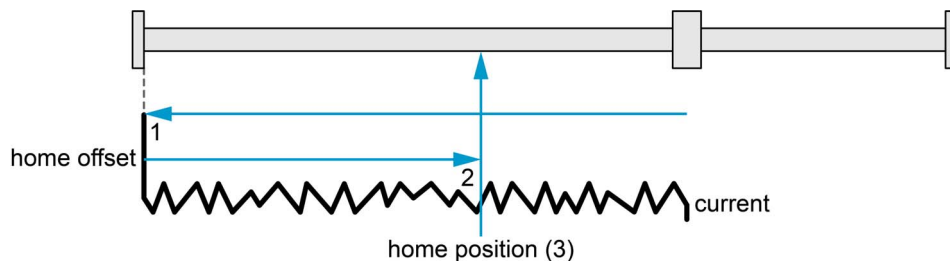

Figure 3-18 Homing method -4

### 3.6 Cyclic Synchronous Position Mode (CSP)

**THE OPERATING MODE IS ONLY AVAILABLE FOR «IDX CANOPEN» AND «IDX ETHERCAT».**

With Cyclic Synchronous Position Mode, the trajectory generator is located in the control device (not in the drive device). It provides a target position to the drive device in cyclic synchronous manner, thus the drive performing position control and torque control.

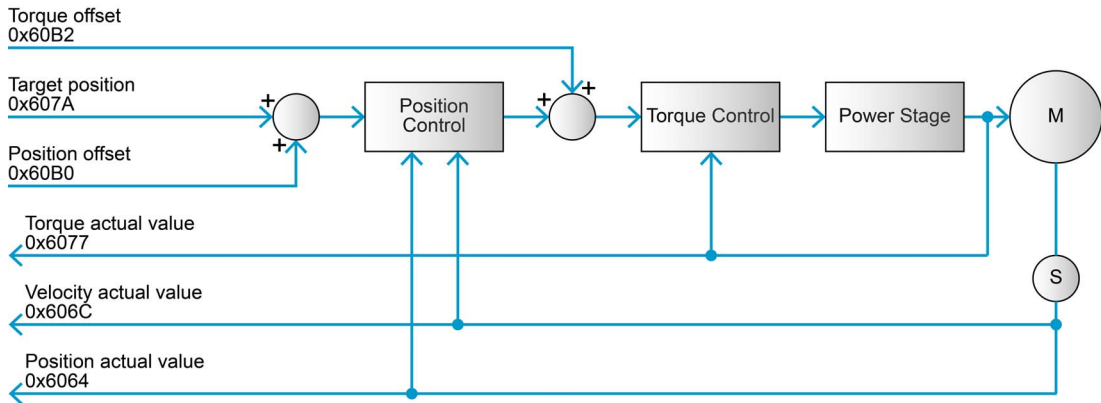

Figure 3-19 Cyclic Synchronous Position Mode – Overview

Cyclic Synchronous Position Mode is based on a position control function. The inputs are →Target position and (optionally) →Position offset. A linear interpolation based on the →Interpolation time period is executed between two position values. This interpolation is active for PDO communication only. The →Velocity offset is not taken into account.

Furthermore, an optional torque offset is being used for feed forward control. The input →Motor data is used to define limitations for the current value (torque). Other features specified in this mode are the function →Software position limit (used to restrict the range of values to avoid unintended positions) as well as →Max motor speed and →Max gear input speed (to limit and monitor the following error). Actual values for position, velocity, and torque are used as output to the control device.

Continued on next page.

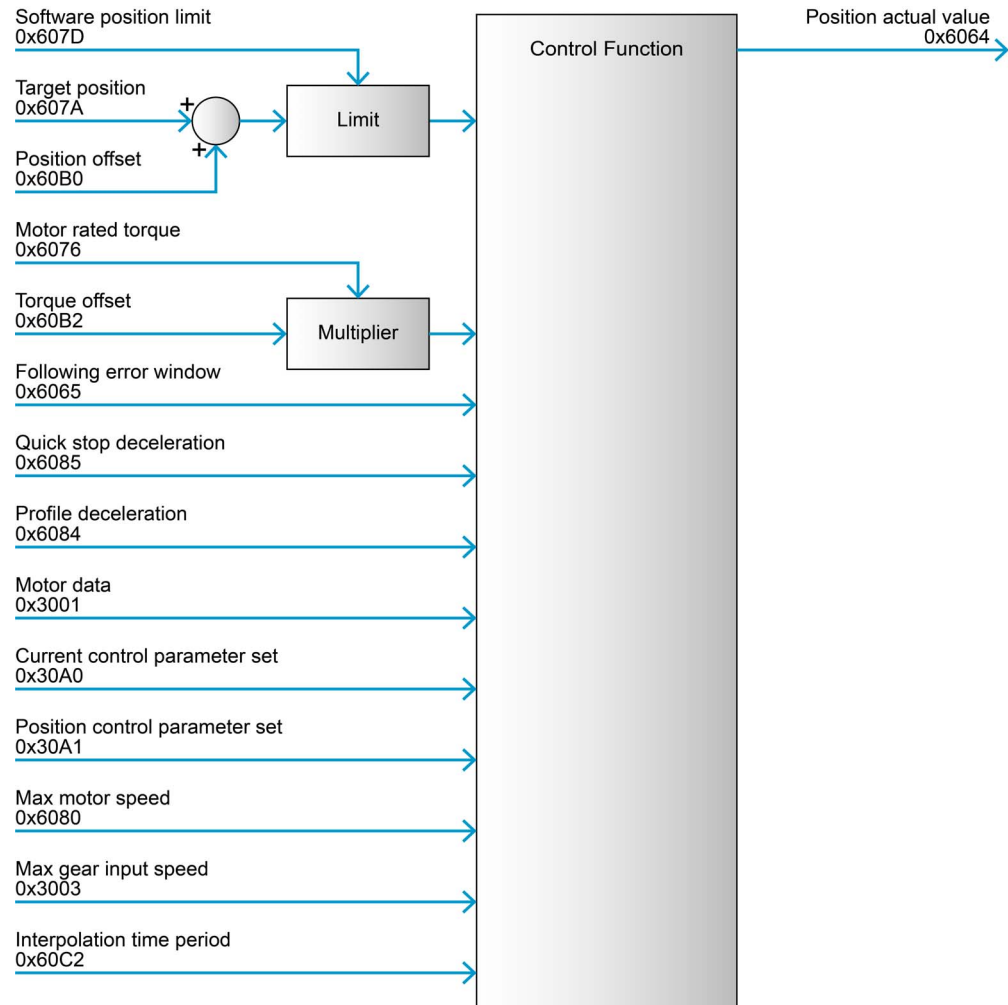

Figure 3-20 Cyclic Synchronous Position Mode – Block diagram

### 3.6.1 How to use «CSP»

#### CONFIGURATION PARAMETERS

Parameter	Index	Description
Nominal current (→Motor data)	0x3001	The maximal permissible continuous current of the motor
Motor torque constant (→Motor data)	0x3001	The torque constant of the motor
→Current control parameter set	0x30A0	Configuration of the current controller gains
→Position control parameter set	0x30A1	Configuration of the position controller.
→Quick stop deceleration	0x6085	Defines the deceleration for the quick stop ramp (*3)
→Profile deceleration	0x6084	Defines the deceleration for the slowdown ramp (*3)
→Following error window	0x6065	The maximal allowed difference of position actual value to position demand value. If exceeded, following error is generated.
→Software position limit	0x607D	Used to restrict the absolute position range. If the target position or the actual position exceeds the range, a software position limit error is generated.
→Motor rated torque	0x6076	Holds the value to which all torque objects are related to
→Max motor speed	0x6080	Indicates the configured maximal permitted speed for the motor. It serves as protection of the motor and is taken from the motor data sheet (active during PDO communication only).
→Max gear input speed	0x3003	Indicates the configured maximal permitted input speed of the gear. It serves as protection of the gear and is taken from the gear data sheet. Together with “Max motor speed”, it limits the speed of the system (active during PDO communication only).
→Interpolation time period	0x60C2	Defines the time interval

(\*3) Deceleration values are used for stopping only (and not for normal operation).

Table 3-34 Cyclic Synchronous Position Mode – Configuration parameters

#### COMMANDING PARAMETERS

Parameter	Index	Description
→Target position	0x607A	Position input value for the position controller (linear interpolation between PDO values)
→Position offset	0x60B0	Optional additive position value which is added to the target position (linear interpolation between PDO values)
→Torque offset	0x60B2	Optional torque feed forward input

Table 3-35 Cyclic Synchronous Position Mode – Commanding parameters

#### CONTROLWORD

Cyclic Synchronous Position Mode does not use mode-specific controlword bits.



**OUTPUT PARAMETERS**

Parameter	Index	Description
→ Torque actual value	0x6077	Actual motor torque value
→ Velocity actual value	0x606C	Actual velocity value [velocity units]
→ Position actual value	0x6064	Actual position is absolute and referenced to system zero position

Table 3-36 Cyclic Synchronous Position Mode – Output parameters

**STATUSWORD (CYCLIC SYNCHRONOUS POSITION MODE-SPECIFIC BITS)**

Bit 15, 14	Bit 13	Bit 12	Bit 11	Bit 10	Bit 9...0
→ Table 6-117	following error	drive follows command value	→ Table 6-117	reserved	→ Table 6-117

Table 3-37 Cyclic Synchronous Position Mode – Statusword

Name	Value	Description
drive follows command value	0	Drive does not follow the target value
	1	Drive is in state operation enables and follows the target and setpoint values of the control device
following error	0	No following error
	1	Difference of position demand value and position actual value exceeds the defined maximal following error

Table 3-38 Cyclic Synchronous Position Mode – Statusword bits

### 3.7 Cyclic Synchronous Velocity Mode (CSV)

With Cyclic Synchronous Velocity Mode, the trajectory generator is located in the control device (not in the drive device). It provides a target velocity to the drive device in cyclic synchronous manner, thus the drive velocity control and torque control.

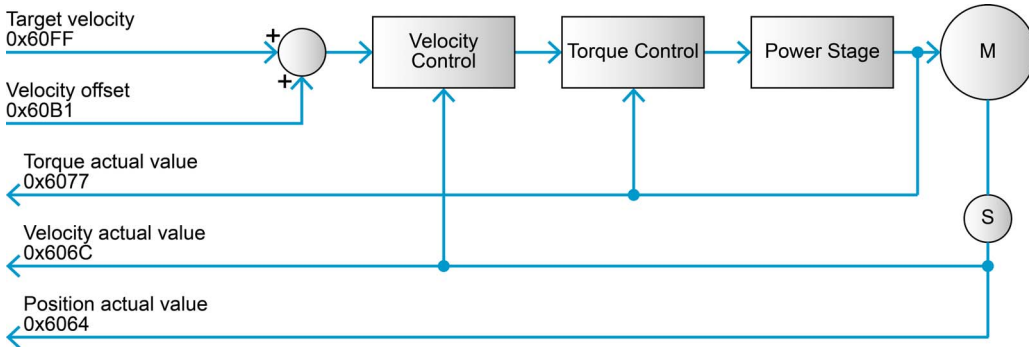

Figure 3-21 Cyclic Synchronous Velocity Mode – Overview

Cyclic Synchronous Velocity Mode is based on velocity control function. The inputs are → Target velocity. Optionally, additive velocity values may be provided by the control system in order to allow a second source for velocity feed forward control. A linear interpolation based on the → Interpolation time period is executed between two velocity values. This interpolation is active for PDO communication only. The → Torque offset is not taken into account.

The input → Motor data is used to define limitations for velocity and current values. Actual values for position, velocity, and torque are used as output to the control device

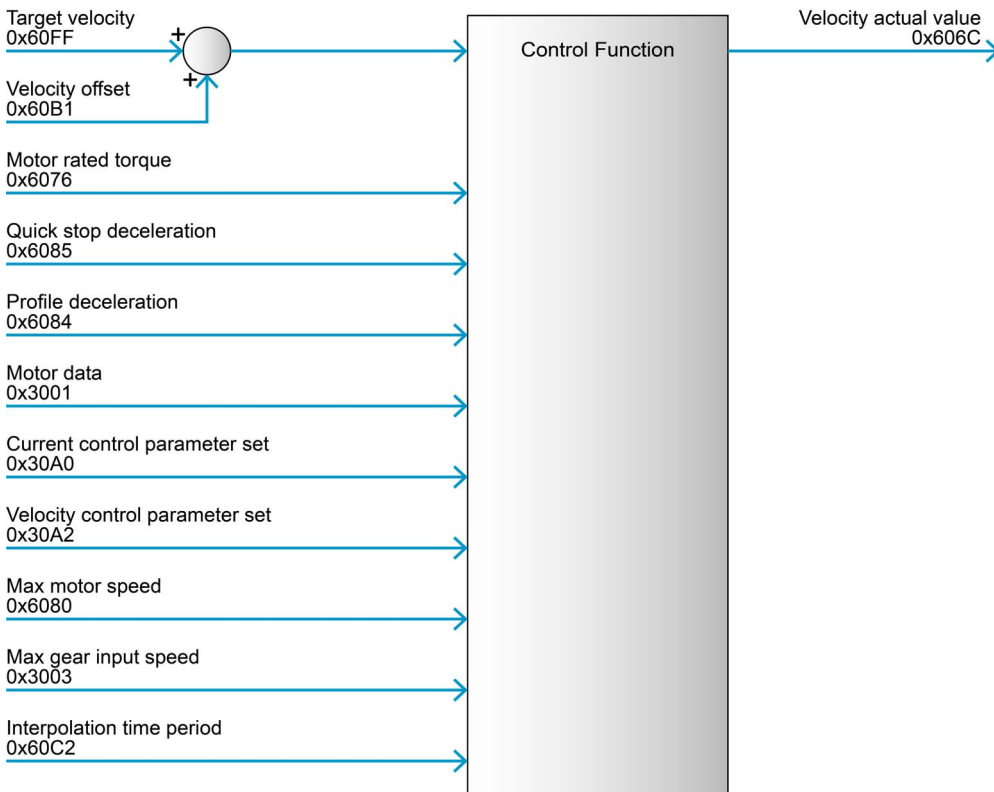

Figure 3-22 Cyclic Synchronous Velocity Mode – Block diagram

### 3.7.1 How to use «CSV»

#### CONFIGURATION PARAMETERS

Parameter	Index	Description
Nominal current (→Motor data)	0x3001	The maximal permissible continuous current of the motor
Motor torque constant (→Motor data)	0x3001	The torque constant of the motor
→Current control parameter set	0x30A0	Configuration of the current controller gains
→Velocity control parameter set	0x30A2	Configuration of the velocity controller
→Quick stop deceleration	0x6085	Defines the deceleration for the quick stop ramp (*3)
→Profile deceleration	0x6084	Defines the deceleration for the slowdown ramp (*3)
→Software position limit	0x607D	Used to restrict the absolute position range. If the actual position exceeds the range, a software position limit error is generated.
→Motor rated torque	0x6076	Holds the value to which all torque objects are related to
→Max motor speed	0x6080	Indicates the configured maximal permitted speed for the motor. It serves as protection of the motor and is taken from the motor data sheet (active during PDO communication only).
→Max gear input speed	0x3003	Indicates the configured maximal permitted input speed of the gear. It serves as protection of the gear and is taken from the gear data sheet. Together with "Max motor speed", it limits the speed of the system (active during PDO communication only).
→Interpolation time period	0x60C2	Defines the time interval

(\*3) Deceleration values are used for stopping only (and not for normal operation).

Table 3-39 Cyclic Synchronous Velocity Mode – Configuration parameters

#### COMMANDING PARAMETERS

Parameter	Index	Description
→Target velocity	0x60FF	Velocity input value for the velocity controller
→Velocity offset	0x60B1	Optional velocity feed forward input

Table 3-40 Cyclic Synchronous Velocity Mode – Commanding parameters

#### CONTROLWORD

Cyclic Synchronous Velocity Mode does not use mode-specific controlword bits.

#### OUTPUT PARAMETERS

Parameter	Index	Description
→Torque actual value	0x6077	Actual motor torque value
→Velocity actual value	0x606C	Actual velocity value [velocity units]
→Position actual value	0x6064	Actual position is absolute and referenced to system zero position

Table 3-41 Cyclic Synchronous Velocity Mode – Output parameters

**STATUSWORD (CYCLIC SYNCHRONOUS VELOCITY MODE-SPECIFIC BITS)**

Bit 15, 14	Bit 13	Bit 12	Bit 11	Bit 10	Bit 9...0
→Table 6-117	reserved	drive follows command value	→Table 6-117	reserved	→Table 6-117

Table 3-42 Cyclic Synchronous Velocity Mode – Statusword

Name	Value	Description
drive follows command value	0	Drive does not follow the target value
	1	Drive is in state operation enables and follows the target and setpoint values of the control device

Table 3-43 Cyclic Synchronous Velocity Mode – Statusword bits

### 3.8 Cyclic Synchronous Torque Mode (CST)

With Cyclic Synchronous Torque Mode, the trajectory generator is located in the control device (not in the drive device). It provides a target torque to the drive device in cyclic synchronous manner, thus the drive performing torque control.

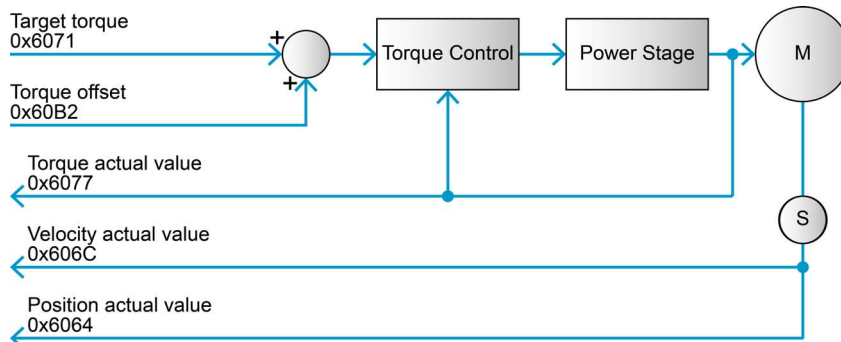

Figure 3-23 Cyclic Synchronous Torque Mode – Overview

Cyclic Synchronous Torque Mode is based on the current control function. The inputs are →Target torque and (optionally) →Torque offset. The input →Motor data is used to define limitations for velocity and current values. Actual values for position, velocity, and torque are used as output to the control device.

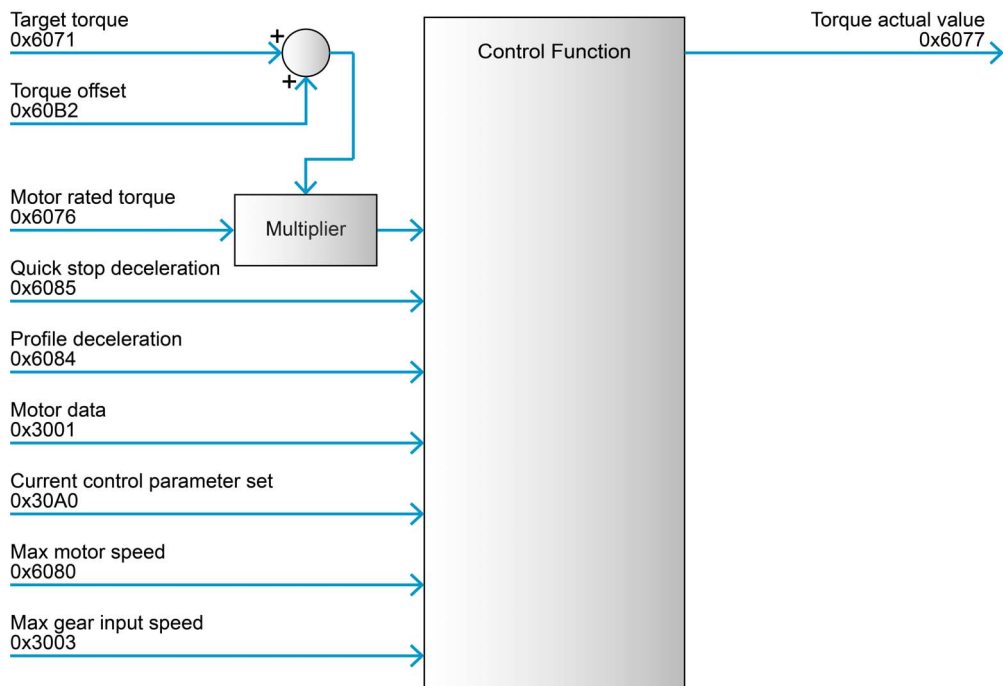

Figure 3-24 Cyclic Synchronous Torque Mode – Block diagram

### 3.8.1 How to use «CST»

#### CONFIGURATION PARAMETERS

Parameter	Index	Description
Nominal current (→Motor data)	0x3001	The maximal permissible continuous current of the motor
Motor torque constant (→Motor data)	0x3001	The torque constant of the motor
→Max motor speed	0x6080	Indicates the configured maximal allowed speed for the motor. It serves as protection of the motor and is taken from the motor data sheet.
→Max gear input speed	0x3003	Indicates the configured maximal permitted input speed of the gear. It serves as protection of the gear and is taken from the gear data sheet. Together with “Max motor speed”, it limits the speed of the system.
→Current control parameter set	0x30A0	Configuration of the current controller gains
→Quick stop deceleration	0x6085	Defines the deceleration for the quick stop ramp (*4)
→Profile deceleration	0x6084	Defines the deceleration for the slowdown ramp (*4)
→Motor rated torque	0x6076	Holds the value to which all torque objects are related to
→Software position limit	0x607D	Contains the sub-parameters “Min position limit” and “Max position limit” that define the absolute position limits of the position demand value and position actual value. A new target position will be checked against these limits.

(\*4) Deceleration values are used for stopping only (and not for normal operation).

Table 3-44 Cyclic Synchronous Torque Mode – Configuration parameters

#### COMMANDING PARAMETERS

Parameter	Index	Description
→Target torque	0x6071	Torque input value for the torque controller
→Torque offset	0x60B2	Optional additive torque which is added to the target torque value

Table 3-45 Cyclic Synchronous Torque Mode – Commanding parameters

#### CONTROLWORD

Cyclic Synchronous Torque Mode does not use mode-specific controlword bits.

#### OUTPUT PARAMETERS

Parameter	Index	Description
→Torque actual value	0x6077	Actual motor torque value
→Velocity actual value	0x606C	Actual velocity value
→Position actual value	0x6064	Actual position is absolute and referenced to system zero position

Table 3-46 Cyclic Synchronous Torque Mode – Output parameters

### STATUSWORD (CYCLIC SYNCHRONOUS TORQUE MODE-SPECIFIC BITS)

Bit 15, 14	Bit 13	Bit 12	Bit 11	Bit 10	Bit 9...0
→Table 6-117	reserved	drive follows command value	→Table 6-117	reserved	→Table 6-117

Table 3-47 Cyclic Synchronous Torque Mode – Statusword

Name	Value	Description
drive follows command value	0	Drive does not follow the target value
	1	Drive is in state operation enables and follows the target and setpoint values of the control device

Table 3-48 Cyclic Synchronous Torque Mode – Statusword bits

### 3.9 Position Control Function

Used for position-based modes, such as «Profile Position Mode» and «Homing Mode».

The control loop is fed with the «Position demand value» and «Position actual value» (the output of the position detection unit) like an encoder as input parameter. The behavior of the control may be influenced by externally applicable control parameters (Position Control Parameter Set). The output of the controller is a current demand value, which serves as input for the current controller.



**Annotation**

Items marked with an asterisk (\*) refer to internal values.

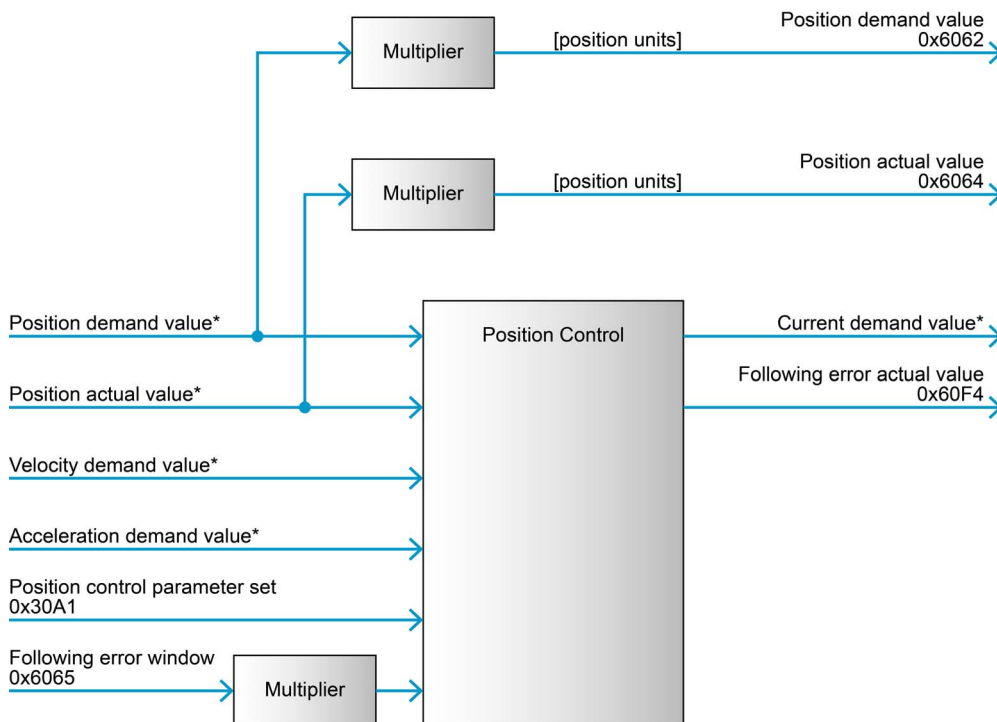

Figure 3-25 Position Control Function – Block diagram

#### 3.9.1 How to use «Position Control Function»

**CONFIGURATION PARAMETERS**

Parameter	Index	Description
→Following error window	0x6065	Defines the following error window. If the difference between Position Actual Value and Position Demand Value is larger than the following error window, a following error will occur.
→Position control parameter set	0x30A1	Configuration of the position controller. The parameters are defined by the controller properties bandwidth, reset time, and damping factor.

Table 3-49 Position Control Function – Configuration parameters

**COMMANDING PARAMETERS**

There are no commanding parameters. The Position Control Function is directly commanded by position-based operating modes (such as Profile Position Mode, Homing Mode).



**OUTPUT PARAMETERS**

Parameter	Index	Description
→Position demand value	0x6062	The operation mode's output. It is used as input for the position control function. Generally, the value is the trajectory generator output.
→Position actual value	0x6064	The actual position is absolute and referenced to system zero position in position units.

Table 3-50 Position Control Function – Output parameters

### 3.10 Velocity Control Function

Used for velocity-based modes, such as «Profile Velocity Mode».

The control loop is fed with the «Velocity demand value» and «Position actual value» (the output of the position detection unit) like an encoder as input parameter. The behavior of the control may be influenced by externally applicable control parameters. The output of the controller is a current demand value, which serves as input for the current controller.



**Annotation**

Items marked with an asterisk (\*) refer to internal values.

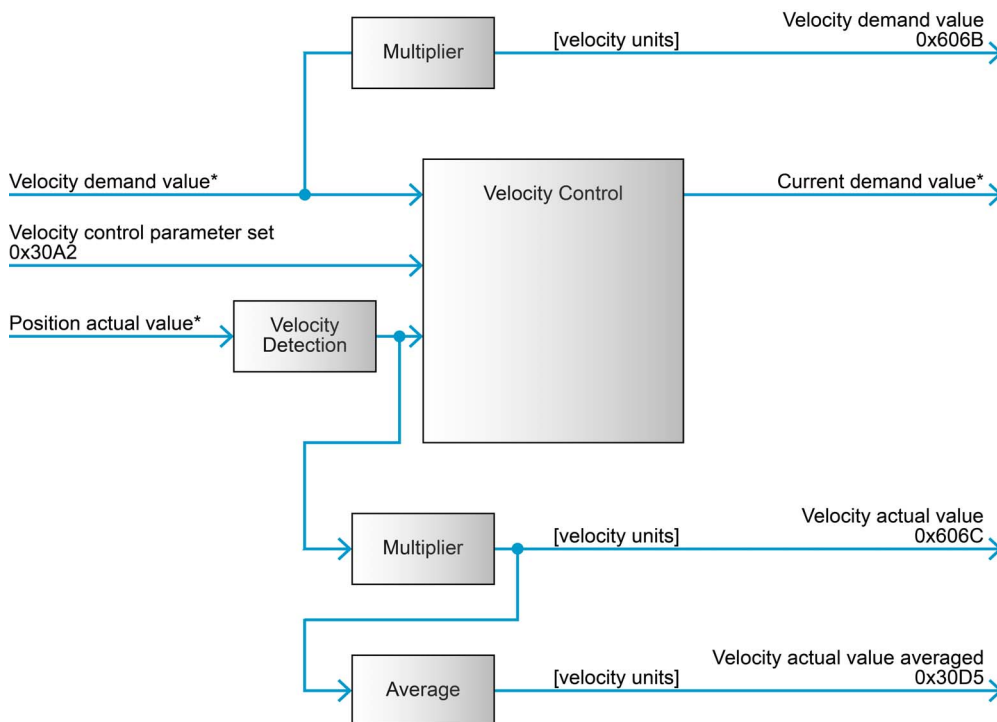

Figure 3-26 Velocity Control Function – Block diagram

#### 3.10.1 How to use «Velocity Control Function»

**CONFIGURATION PARAMETERS**

Parameter	Index	Description
→ Velocity control parameter set	0x30A2	Configuration of the velocity controller gains

Table 3-51 Velocity Control Function – Configuration parameters

**COMMANDING PARAMETERS**

There are no commanding parameters. The Velocity Control Function is directly commanded by velocity-based operating modes (such as Profile Velocity Mode).

**OUTPUT PARAMETERS**

Parameter	Index	Description
→Velocity demand value	0x606B	The operation mode's output. It is used as input for the velocity control function. Generally, the value is the output of the trajectory generator.
→Velocity actual value	0x606C	The actual velocity value
→Velocity actual value averaged	0x30D5	The averaged actual velocity value

Table 3-52 Velocity Control Function – Output Parameters

### 3.11 Current Control Function

All operating modes are based on the current control function. The «Current demand value» is received from a superordinate position or the velocity controller.



**Annotation**

Items marked with an asterisk (\*) refer to internal values.

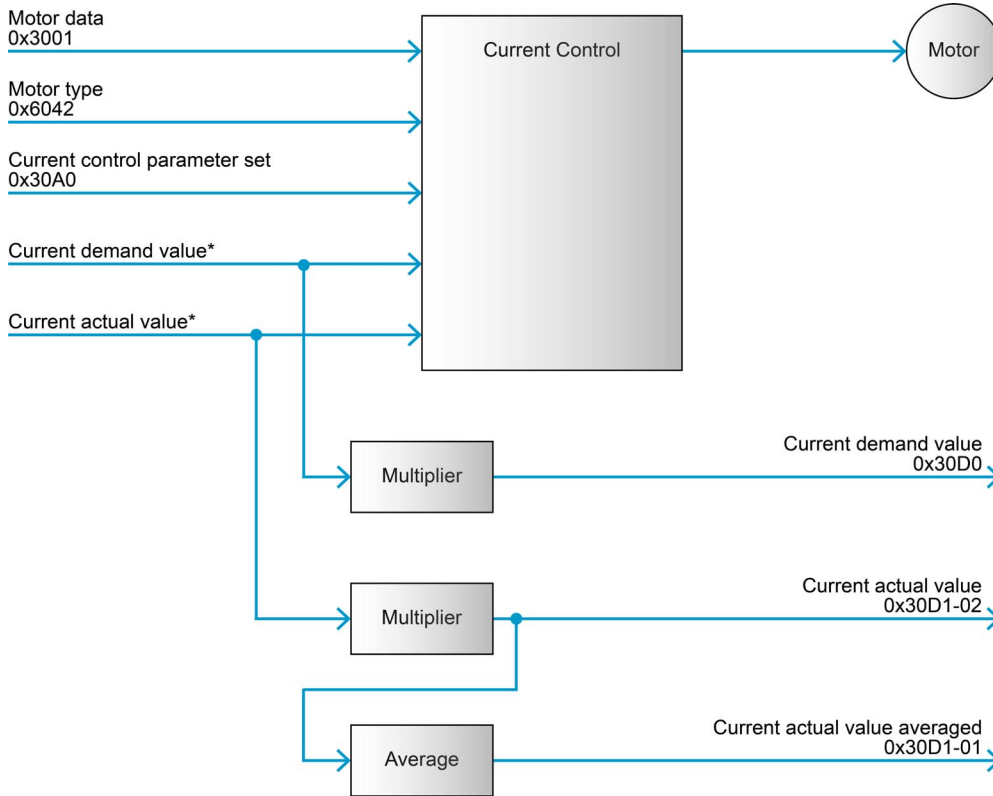

Figure 3-27 Current Control Function – Block diagram

#### 3.11.1 How to use «Current Control Function»

**CONFIGURATION PARAMETERS**

Parameter	Index	Description
→Current control parameter set	0x30A0	Configuration of the current controller gains
→Motor data	0x3001	Used for configuration of motor-dependent parameters
→Motor type	0x6402	Used to define the type of motor

Table 3-53 Current Control Function – Configuration parameters

**COMMANDING PARAMETERS**

There are no commanding parameters. The Current Control Function is commanded by the control loops «Position control function» or «Velocity control function», or directly by operating mode «Cyclic Synchronous Torque Mode».

**OUTPUT PARAMETERS**

Parameter	Index	Description
→Current demand value	0x30D0	Set value for current controller
→Current actual values	0x30D1	The averaged and actual current value

Table 3-54 Current Control Function – Output parameters

**••page intentionally left blank••**

## 4 INPUTS AND OUTPUTS

### 4.1 Digital Inputs

Available are predefined functions and general purpose inputs for process control.

Configuration of the digital input functions is done with →“Configuration of digital inputs” on page 6-162, the polarity is set with →“Digital input properties” on page 6-161.

The input logic state is read with →“Digital input properties” on page 6-161 while the functionality state is read with →“Digital inputs” on page 6-208.

**WITH «IDX I/O», THE FUNCTIONALITY OF BIT 25, 24, 2, 1, 0 ARE NOT AVAILABLE.**

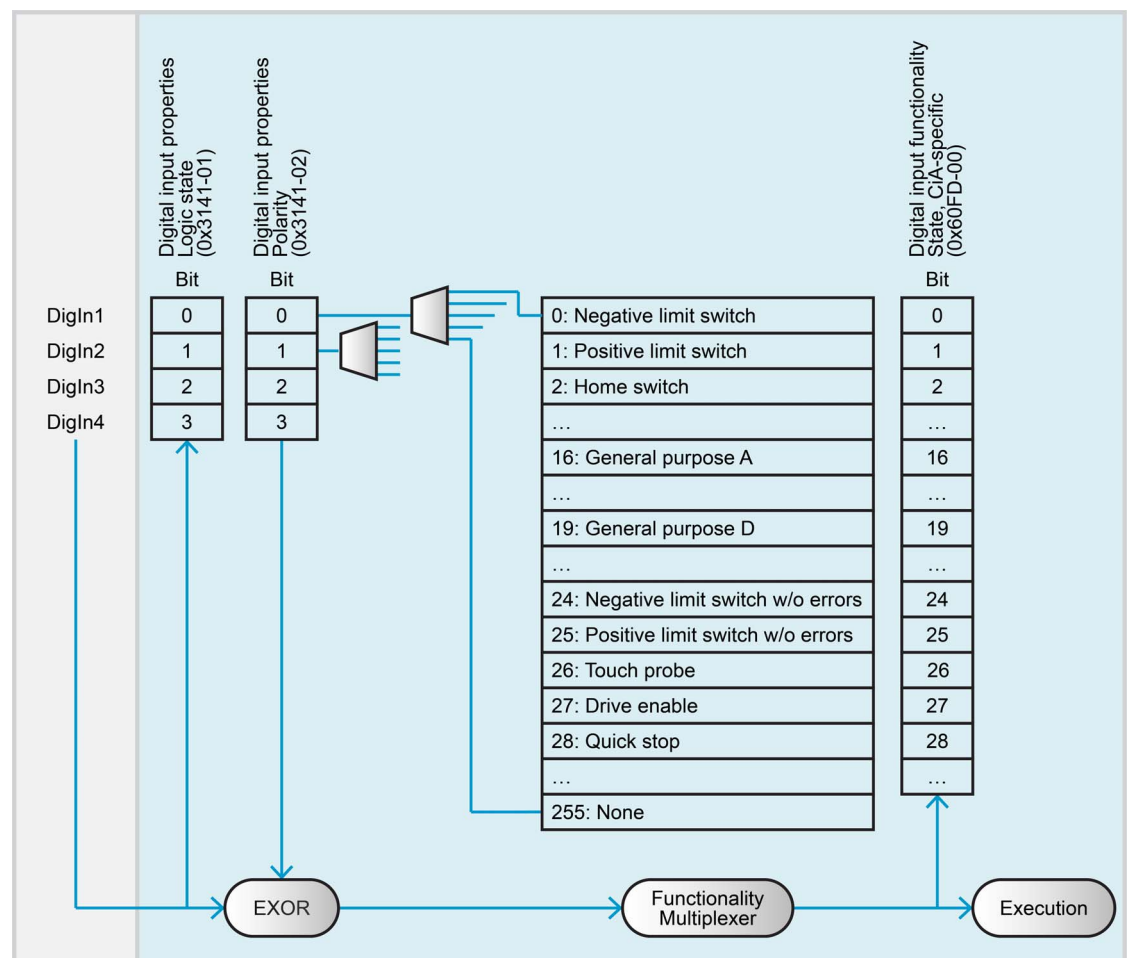

Figure 4-28 Digital input functionality

#### DIGITAL INPUT TIMING BEHAVIOR

- **Hardware** For details on voltage levels and switching delays →separate document «Hardware Reference» of respective controller.
- **Software filter** The digital inputs are filtered to suppress spikes. For digital inputs, the filter has a length of 1 ms. Therefore, to detect a state change (edge), the input level must be stable for more than 1 ms.
- **Update rates** The digital input functionality states (→Digital inputs) and the →Digital input properties are updated with 1 kHz.

## 4.2 Digital Outputs

Available are predefined functions and general purpose outputs for process control.

Configuration of the digital output functions is done with →“Configuration of digital outputs” on page 6-165, the polarity is set with →“Digital output properties” on page 6-164.

The functionality state can be set with →“Digital outputs” on page 6-209, the logic state of the corresponding pin can be read with →“Digital output properties” on page 6-164.

**WITH FACTORY-EQUIPPED INTERNAL BRAKE, THE FUNCTIONALITY OF BIT 24 IS NOT AVAILABLE.**

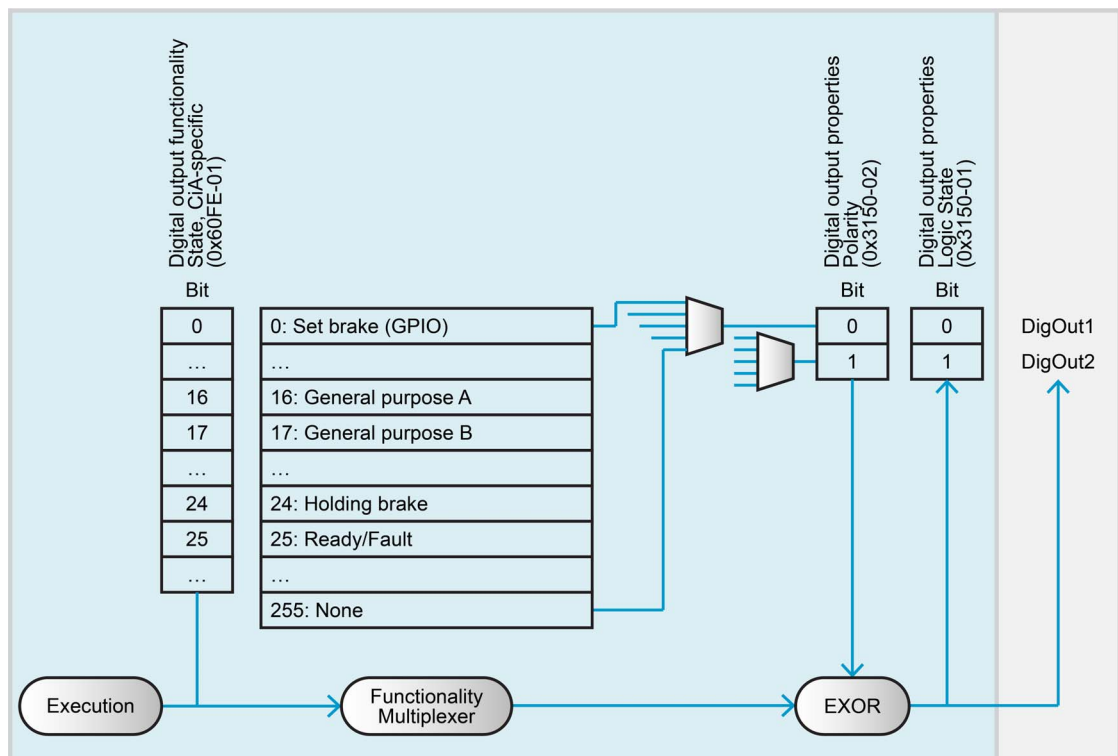

Figure 4-29 Digital output functionality

### DIGITAL OUTPUT TIMING BEHAVIOR

- **Hardware** For details on voltage levels and switching delays →separate document «Hardware Reference» of respective controller.
- **Update rates** Digital outputs (→Digital outputs) are updated when the object is written, no update rate applies. The same applies for the logic state (→Digital output properties).



### 4.3 Analog Inputs

The analog inputs may be used for general purpose process values, such as temperature, pressure, torque from an external sensor, etc. The values are given in →“Analog input properties” on page 6-168.

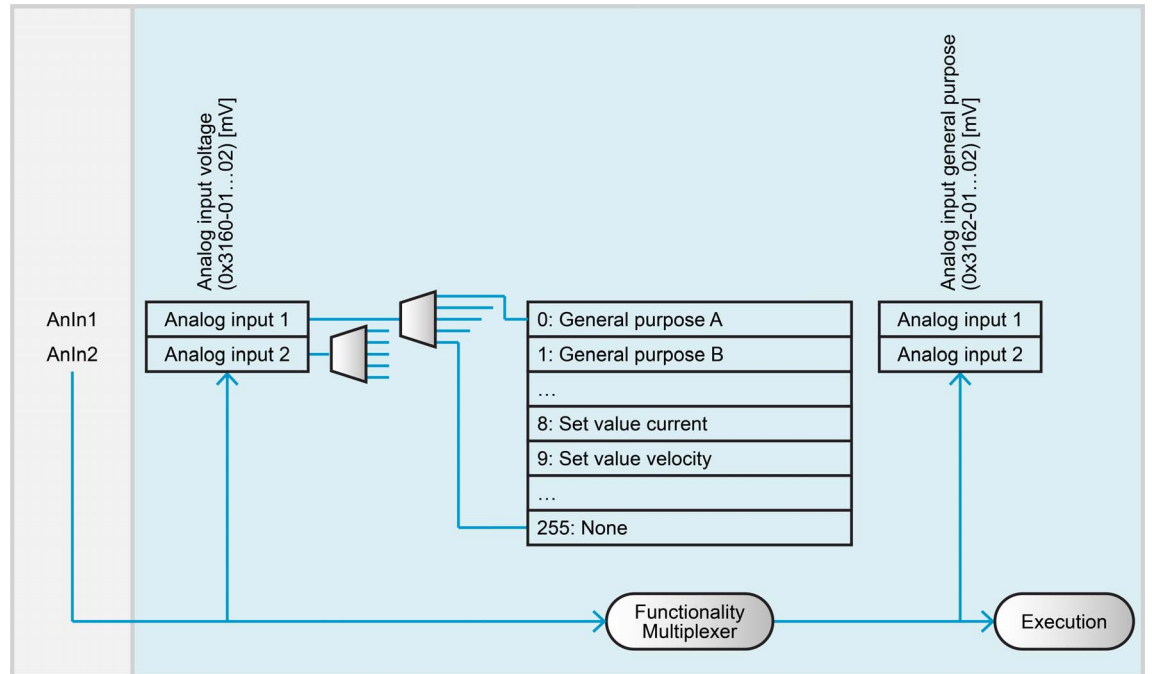

Figure 4-30 Analog input functionality

••page intentionally left blank••

## 5 COMMUNICATION

The device supports communication profiles for USB, CANopen, and EtherCAT. You can find detailed information on the subject in separate document → «IDX Communication Guide». For sources of supply see → chapter “1.1.6 Sources for additional Information” on page 1-10.

### 5.1 USB Communication

The device’s USB interface follows the «Universal Serial Bus Specification Revision 2.0». The device always communicates as a slave and uses the «maxon Serial V2» protocol.

### 5.2 CAN Communication

The «IDX CANopen» communication follows the CiA CANopen specifications:

- CiA 301 V4.2; CANopen application layer and communication profile
- CiA 306 V1.3; CANopen electronic data sheet specification
- CiA 402 V4.0; CANopen drives and motion control device profile



**Find details here:**

→ «IDX Communication Guide», chapter “3 CAN Communication”

### 5.3 EtherCAT Communication

The «IDX EtherCAT» communication follows the EtherCAT Technology Group’s and CiA CANopen specifications:

- ETG.1000 V1.0.4; EtherCAT Specification
- ETG.1020 V1.2.0; EtherCAT Protocol Enhancements Specification
- ETG.2000 V1.0.9; EtherCAT Slave Information (ESI) Specification
- CiA 402 V4.0; CANopen drives and motion control device profile



**Find details here:**

→ «IDX Communication Guide», chapter “4 EtherCAT Communication”

### 5.4 Gateway Communication (USB to CAN)

The «IDX CANopen» provides a USB-to-CAN gateway that permits the master to access all other «IDX CANopen» connected to the CAN bus via USB port. In addition, other CANopen devices (I/O modules) that support the CANopen standard CiA 301 may also be accessed.

**••page intentionally left blank••**

## 6 OBJECT DICTIONARY

### 6.1 Overview

#### 6.1.1 Object Data Types

Index	Name	Base type	Description	Size [Bits]	Range
0x0001	BOOLEAN	BOOL	False/True	1	0.1
0x0002	INTEGER8	SINT	Short Integer	8	$-2^7 \dots 2^7 - 1$
0x0003	INTEGER16	INT	Integer	16	$-2^{15} \dots 2^{15} - 1$
0x0004	INTEGER32	DINT	Double Integer	32	$-2^{31} \dots 2^{31} - 1$
0x0015	INTEGER64	LINT	Long Integer	64	$-2^{63} \dots 2^{63} - 1$
0x0005	UNSIGNED8	USINT	Unsigned Short Integer	8	$0 \dots 2^8 - 1$
0x0006	UNSIGNED16	UINT	Unsigned Integer	16	$0 \dots 2^{16} - 1$
0x0007	UNSIGNED32	UDINT	Unsigned Double Integer	32	$0 \dots 2^{32} - 1$
0x001B	UNSIGNED64	ULINT	Unsigned Long Integer	64	$0 \dots 2^{64} - 1$
0x0009	VISIBLE_STRING	STRING(n)	Visible String (1 octet per character)	8*n	–
0x000A	OCTET_STRING	ARRAY[0...n] of USINT	Sequence of octets (data type USINT)	8*(n+1)	–
0x0021	PDO_MAPPING	–	PDO mapping Parameter Record	–	–
0x0023	IDENTITY	–	Identity Parameter Record	–	–

Table 6-55 Object data types

#### 6.1.2 Object Codes

Object code	Object name
0x0007	VAR
0x0008	ARRAY
0x0009	RECORD

Table 6-56 Object codes

#### 6.1.3 Object Access Types

Access type	Description
RW	read and write access
RO	read only access
WO	write only access
CONST	read only access value is constant

Table 6-57 Object access types

#### 6.1.4 Object Flags

Flag	Code	Description
PDO mapping	TXPDO, RXPDO	Entry can be mapped as TxPdo or as RxPdo
Backup	YES/NO	Entry can be stored/not stored in non-volatile memory

Table 6-58 Object flags

## 6.1.5 Entries Overview

Index	Name	Object code	CANopen	EtherCAT	I/O
0x1000	→Device type	VAR	X	X	X
0x1001	→Error register	VAR	X	X	X
0x1003	→Error history	ARRAY	X		X
0x1005	→COB-ID SYNC	VAR	X		
0x1008	→Manufacturer device name	VAR	X	X	X
0x1010	→Store parameters	ARRAY	X	X	X
0x1011	→Restore default parameters	ARRAY	X	X	X
0x1014	→COB-ID EMCY	VAR	X		
0x1016	→Consumer heartbeat time	ARRAY	X		
0x1017	→Producer heartbeat time	VAR	X		
0x1018	→Identity object	RECORD	X	X	X
0x10F3	→Diagnosis History	RECORD		X	
0x1200	→SDO server parameter	RECORD	X		
0x1400	→Receive PDO 1 parameter	RECORD	X		
0x1401	→Receive PDO 2 parameter	RECORD	X		
0x1402	→Receive PDO 3 parameter	RECORD	X		
0x1403	→Receive PDO 4 parameter	RECORD	X		
0x1600	→Receive PDO 1 mapping	RECORD	X	X	
0x1601	→Receive PDO 2 mapping	RECORD	X	X	
0x1602	→Receive PDO 3 mapping	RECORD	X	X	
0x1603	→Receive PDO 4 mapping	RECORD	X	X	
0x1800	→Transmit PDO 1 parameter	RECORD	X		
0x1801	→Transmit PDO 2 parameter	RECORD	X		
0x1802	→Transmit PDO 3 parameter	RECORD	X		
0x1803	→Transmit PDO 4 parameter	RECORD	X		
0x1A00	→Transmit PDO 1 mapping	RECORD	X	X	
0x1A01	→Transmit PDO 2 mapping	RECORD	X	X	
0x1A02	→Transmit PDO 3 mapping	RECORD	X	X	
0x1A03	→Transmit PDO 4 mapping	RECORD	X	X	
0x1C00	→SYNC manager communication type	ARRAY		X	
0x1C12	→SYNC manager 2 PDO assignment	ARRAY		X	
0x1C13	→SYNC manager 3 PDO assignment	ARRAY		X	
0x1C32	→SYNC manager 2 parameter	RECORD		X	
0x1C33	→SYNC manager 3 parameter	RECORD		X	
0x1F50	→Program data	ARRAY	X	X	X
0x1F51	→Program control	ARRAY	X	X	X
0x1F56	→Program software identification	ARRAY	X	X	X
0x1F57	→Flash status identification	ARRAY	X	X	X
0x2000	→Node-ID	VAR	X	X	X
0x2001	→CAN bit rate	VAR	X		

Continued on next page.

Index	Name	Object code	CANopen	EtherCAT	I/O
0x2006	→USB frame timeout	VAR	X	X	X
0x200A	→CAN bit rate display	VAR	X		
0x2010	→Active fieldbus	VAR	X	X	X
0x2011	→Active controller type	VAR	X	X	X
0x2100	→Additional identity	ARRAY	X	X	X
0x2101	→Extension 1 identity	RECORD		X	
0x210C	→Custom persistent memory	ARRAY	X	X	
0x2200	→Power supply	RECORD	X	X	X
0x3000	→Axis configuration	ARRAY	X	X	X
0x3001	→Motor data	RECORD	X	X	X
0x3002	→Electrical system parameters	RECORD	X	X	X
0x3003	→Gear configuration	ARRAY	X	X	X
0x3012	→SSI absolute encoder	RECORD	X	X	X
0x30A0	→Current control parameter set	ARRAY	X	X	X
0x30A1	→Position control parameter set	ARRAY	X	X	
0x30A2	→Velocity control parameter set	ARRAY	X	X	X
0x30A3	→Velocity observer parameter set	ARRAY	X	X	X
0x30B0	→Home position	VAR	X	X	
0x30B1	→Home offset move distance	VAR	X	X	
0x30B2	→Current threshold for homing mode	VAR	X	X	
0x30D0	→Current demand value	VAR	X	X	X
0x30D1	→Current actual values	ARRAY	X	X	X
0x30D2	→Torque actual values	ARRAY	X	X	X
0x30D3	→Velocity actual values	ARRAY	X	X	X
0x30E0	→Standstill window configuration	RECORD	X	X	X
0x3141	→Digital input properties	ARRAY	X	X	X
0x3142	→Configuration of digital inputs	ARRAY	X	X	X
0x3150	→Digital output properties	ARRAY	X	X	X
0x3151	→Configuration of digital outputs	ARRAY	X	X	X
0x3158	→Holding brake parameters	RECORD	X	X	X
0x3160	→Analog input properties	ARRAY	X	X	X
0x3161	→Configuration of analog inputs	ARRAY	X	X	X
0x3162	→Analog input general purpose	ARRAY	X	X	X
0x3163	→Analog input adjustment	RECORD	X	X	X
0x3170	→Analog input current set value properties	ARRAY	X	X	X
0x3171	→Analog input velocity set value properties	ARRAY	X	X	X
0x3200	→Motor protection	ARRAY	X	X	X
0x3201	→Thermal controller protection	ARRAY	X	X	X
0x6007	→Abort connection option code	VAR	X	X	X
0x603F	→Error code	VAR	X	X	X
0x6040	→Controlword	VAR	X	X	X

Continued on next page.



Index	Name	Object code	CANopen	EtherCAT	I/O
0x6041	→Statusword	VAR	X	X	X
0x605A	→Quick stop option code	VAR	X	X	X
0x605B	→Shutdown option code	VAR	X	X	X
0x605C	→Disable operation option code	VAR	X	X	X
0x605E	→Fault reaction option code	VAR	X	X	X
0x6060	→Modes of operation	VAR	X	X	X
0x6061	→Modes of operation display	VAR	X	X	X
0x6062	→Position demand value	VAR	X	X	
0x6064	→Position actual value	VAR	X	X	X
0x6065	→Following error window	VAR	X	X	
0x6066	→Following error timeout	VAR	X	X	
0x606B	→Velocity demand value	VAR	X	X	X
0x606C	→Velocity actual value	VAR	X	X	X
0x6071	→Target torque	VAR	X	X	X
0x6076	→Motor rated torque	VAR	X	X	X
0x6077	→Torque actual value	VAR	X	X	X
0x607A	→Target position	VAR	X	X	
0x607B	→Position range limit	ARRAY	X	X	
0x607D	→Software position limit	ARRAY	X	X	
0x607F	→Max profile velocity	VAR	X	X	X
0x6080	→Max motor speed	VAR	X	X	X
0x6081	→Profile velocity	VAR	X	X	
0x6083	→Profile acceleration	VAR	X	X	X
0x6084	→Profile deceleration	VAR	X	X	X
0x6085	→Quick stop deceleration	VAR	X	X	X
0x6086	→Motion profile type	VAR	X	X	
0x6098	→Homing method	VAR	X	X	
0x6099	→Homing speeds	ARRAY	X	X	
0x609A	→Homing acceleration	VAR	X	X	
0x60A8	→SI unit position	VAR	X	X	X
0x60A9	→SI unit velocity	VAR	X	X	X
0x60AA	→SI unit acceleration	VAR	X	X	X
0x60B0	→Position offset	VAR	X	X	
0x60B1	→Velocity offset	VAR	X	X	X
0x60B2	→Torque offset	VAR	X	X	X
0x60B8	→Touch probe function	VAR	X	X	
0x60B9	→Touch probe status	VAR	X	X	
0x60BA	→Touch probe position 1 positive value	VAR	X	X	
0x60BB	→Touch probe position 1 negative value	VAR	X	X	
0x60C2	→Interpolation time period	RECORD	X	X	
0x60C5	→Max acceleration	VAR	X	X	X

Continued on next page.

Index	Name	Object code	CANopen	EtherCAT	I/O
0x60D0	→Touch probe source	ARRAY	X	X	
0x60D5	→Touch probe 1 positive edge counter	VAR	X	X	
0x60D6	→Touch probe 1 negative edge counter	VAR	X	X	
0x60F4	→Following error actual value	VAR	X	X	
0x60FD	→Digital inputs	VAR	X	X	X
0x60FE	→Digital outputs	ARRAY	X	X	X
0x60FF	→Target velocity	VAR	X	X	X
0x6402	→Motor type	VAR	X	X	X
0x6502	→Supported drive modes	VAR	X	X	X
0xF000	→Modular device profile	RECORD		X	
0xF030	→Configured module ident list	ARRAY		X	
0xF050	→Detected module ident list	ARRAY		X	

Table 6-59 Object Dictionary (overview)

## 6.2 Objects



### Annotation

Items marked with an asterisk (\*) refer to internal values.

### 6.2.1 Device type

Describes the device type. The lower word stands for the supported device profile number. The value 0x0192 (402) means that the device follows CiA 402 “CANopen device profile for drives and motion control”. The higher word holds information on the drive type. The value 0x0002 means that the drive is a servo drive.

Name	Device type
Index	0x1000
Subindex	0x00
Data type	UNSIGNED32
Access type	RO
Default value	0x00020192
Value range	–
PDO mapping	NO
Backup	NO

### 6.2.2 Error register

The error register for the device. The device maps internal errors in this byte.

Name	Error register
Index	0x1001
Subindex	0x00
Data type	UNSIGNED8
Access type	RO
Default value	0
Value range	–
PDO mapping	NO
Backup	NO

Bit	Description
7	Motion error
6	reserved (always 0)
5	Device profile-specific
4	Communication error
3	Temperature error
2	Voltage error
1	Current error
0	Generic error

Table 6-60 Error register bits

## 6.2.3 Error history

**THE OBJECT IS ONLY AVAILABLE FOR «IDX CANOPEN» AND «IDX I/O».**

Holds errors that have occurred on the device and have been signaled via the emergency object.

Name	Error history
Index	0x1003
Object code	ARRAY
Highest subindex supported	5

### 6.2.3.1 Number of errors

Contains the number of actual errors that are recorded in the array starting at subindex 1. Writing a “0” (zero) deletes the error history (empties the array). Values higher than “0” (zero) are not allowed to write.

Name	Number of errors
Index	0x1003
Subindex	0x00
Data type	UNSIGNED8
Access type	RW
Default value	0
Value range	0 5
PDO mapping	NO
Backup	NO

### 6.2.3.2 Error history

Every new error code is stored at subindex 1, the older ones move down the list. The error numbers compose of a 16-bit error code and 16-bit additional error information that are always zero.

Names	Error history 1 Error history 2 Error history 3 Error history 4 Error history 5
Index	0x1003
Subindex	0x01...0x05
Data type	UNSIGNED32
Access type	RO
Default value	–
Value range	– –
PDO mapping	NO
Backup	NO

## 6.2.4 COB-ID SYNC

**THE OBJECT IS ONLY AVAILABLE FOR «IDX CANOPEN».**

The Communication Object Identifier of the synchronization object.

Name	COB-ID SYNC	
Index	0x1005	
Subindex	0x00	
Data type	UNSIGNED32	
Access type	CONST	
Default value	0x00000080	
Value range	–	–
PDO mapping	NO	
Backup	NO	

## 6.2.5 Manufacturer device name

Holds the manufacturer device name.

Name	Manufacturer device name	
Index	0x1008	
Subindex	0x00	
Data type	VISIBLE_STRING	
Access type	RO	
Default value	IDX	
Value range	–	–
PDO mapping	NO	
Backup	NO	

## 6.2.6 Store parameters

Controls saving of configuration parameters in a non-volatile memory.

Name	Store parameters
Index	0x1010
Object code	ARRAY
Highest subindex supported	1

In order to avoid storage of parameters by mistake, storage should only be executed when a specific signature is written to the respective subindex.

On read access, the device will always return the value 0x00000001.

BYTE	MSB			LSB
Character	'e'	'v'	'a'	's'
Hex value	0x65	0x76	0x61	0x73

Table 6-61 Store parameters signature

### 6.2.6.1 Save all parameters

All parameters of the controller will be stored in a non-volatile memory if the code “save” is written to the object.

Name	Save all parameters
Index	0x1010
Subindex	0x01
Data type	UNSIGNED32
Access type	RW
Default value	0x00000001
Value range	→ Table 6-61
PDO mapping	NO
Backup	NO

## 6.2.7 Restore default parameters

Configuration parameters are restored to the default values.

Restoring the default parameters is permitted in NMT state «Pre-Operational» and device state «Power Disable», only. The default values are only set valid after the device is reset or power cycled.

Name	Restore default parameters
Index	0x1011
Object code	ARRAY
Highest subindex supported	4

In order to avoid restoring of default parameters by mistake, restoring should only be executed when a specific signature is written to the respective subindex.

On read access, the device will always return the value 0x00000001.

BYTE	MSB			LSB
Character	'd'	'a'	'o'	'l'
Hex value	0x64	0x61	0x6F	0x6C

Table 6-62 Restore default parameters signature

### 6.2.7.1 Restore all default parameters

All parameters of the controller will be stored in a non-volatile memory, if the code "load" is written to the object. Only permitted if all axes of the controller are in device state «Power Disable».

Name	Restore all default parameters
Index	0x1011
Subindex	0x01
Data type	UNSIGNED32
Access type	RW
Default value	0x00000001
Value range	→ Table 6-62
PDO mapping	NO
Backup	NO

## 6.2.8 COB-ID EMCY

**THE OBJECT IS ONLY AVAILABLE FOR «IDX CANOPEN».**

The Communication Object Identifier of the emergency object.

Name	COB-ID EMCY
Index	0x1014
Subindex	0x00
Data type	UNSIGNED32
Access type	RO
Default value	0x00000080 + Node-ID
Value range	–
PDO mapping	NO
Backup	NO

## 6.2.9 Consumer heartbeat time

### THE OBJECT IS ONLY AVAILABLE FOR «IDX CANOPEN».

Defines the expected cycle time of the heartbeat. The heartbeat times are higher than the corresponding producer heartbeat times configured on the CANopen device that produces this heartbeat.

Monitoring starts after reception of the first heartbeat. The time is given as multiple of 1 ms.

If the heartbeat time is “0” (zero), the Node-ID can also be set to “0” (zero). The object entry will not be used.

We recommend to set the consumer heartbeat time value at least 20 ms higher than the time value of the producer.

Typically, the master (or another slave) produces the heartbeat. Therefore, it does not make sense nor even may work properly if the producer Node-ID configured in this object is equal to the Node-ID in use by this device.

Related objects: → “Producer heartbeat time” on page 6-69

Name	Consumer heartbeat time
Index	0x1016
Object code	ARRAY
Highest subindex supported	2

### 6.2.9.1 Consumer n heartbeat time

Names	Consumer 1 heartbeat time Consumer 2 heartbeat time
Index	0x1016
Subindex	0x01...0x02
Data type	UNSIGNED32
Access type	RW
Default value	0
Value range	→ Table 6-63
PDO mapping	NO
Backup	YES

Bit 31...24	Bit 23...16	Bit 15...0
reserved (0)	Node-ID	heartbeat time

Table 6-63 Consumer heartbeat time – Structure



## 6.2.10 *Producer heartbeat time*

**THE OBJECT IS ONLY AVAILABLE FOR «IDX CANOPEN».**

Defines the cycle time of the heartbeat. The producer heartbeat time "0" (zero) will not be used. The time must be a multiple of 1 ms.

Name	Producer heartbeat time	
Index	0x1017	
Subindex	0x00	
Data type	UNSIGNED16	
Access type	RW	
Default value	0	
Value range	–	–
PDO mapping	NO	
Backup	YES	

## 6.2.11 *Identity object*

Provides general identification information on the device.

Name	Identity object	
Index	0x1018	
Object code	RECORD	
Highest subindex supported	4	

### 6.2.11.1 *Vendor ID*

Unique "maxon motor ag" vendor identification defined by CiA.

Name	Vendor ID	
Index	0x1018	
Subindex	0x01	
Data type	UNSIGNED32	
Access type	RO	
Default value	0x000000FB	
Value range	–	–
PDO mapping	NO	
Backup	NO	

### 6.2.11.2 Product code

The high word contains the hardware version. The low word contains the application number.

Name	Product code	
Index	0x1018	
Subindex	0x02	
Data type	UNSIGNED32	
Access type	RO	
Default value	–	
Value range	–	–
PDO mapping	NO	
Backup	NO	

Hardware version	Hardware
0x6751	IDX 56

Table 6-64 Definition of hardware version

### 6.2.11.3 Revision number

The high word contains the software version. The low word contains the application version.

Name	Revision number	
Index	0x1018	
Subindex	0x03	
Data type	UNSIGNED32	
Access type	RO	
Default value	–	
Value range	–	–
PDO mapping	NO	
Backup	NO	

### 6.2.11.4 Serial number

Contains the last 8 digits of the device serial number.

Related objects: → “Serial number complete” on page 6-124

Name	Serial number	
Index	0x1018	
Subindex	0x04	
Data type	UNSIGNED32	
Access type	RO	
Default value	–	
Value range	–	–
PDO mapping	NO	
Backup	NO	

## 6.2.12 Diagnosis History

### THE OBJECT IS ONLY AVAILABLE FOR «IDX ETHERCAT».

Allows the EtherCAT master to access the latest diagnosis messages. Up to maximal five diagnosis messages can be accessed.

In case of an error, the corresponding message will be displayed in «TwinCAT» (tab “Diag History”) and in «EPOS Studio». The error may be cleared by writing the value 0x80 to the →“Controlword” on page 6-180.

Name	Diagnosis History
Index	0x10F3
Object code	RECORD
Highest subindex supported	10

### 6.2.12.1 Maximum messages

Represents the number of diagnosis messages that can be stored in the diagnosis history (subindex 6 onwards).

Name	Maximum messages	
Index	0x10F3	
Subindex	0x01	
Data type	UNSIGNED8	
Access type	RO	
Default value	5	
Value range	5	5
PDO mapping	NO	
Backup	NO	

### 6.2.12.2 Newest message

The subindex of the latest diagnosis message (6...255).

Name	Newest message	
Index	0x10F3	
Subindex	0x02	
Data type	UNSIGNED8	
Access type	RO	
Default value	0	
Value range	0, 6	10
PDO mapping	NO	
Backup	NO	

### 6.2.12.3 *Newest acknowledged message*

Name	Newest acknowledged message	
Index	0x10F3	
Subindex	0x03	
Data type	UNSIGNED8	
Access type	RW	
Default value	0	
Value range	0	255
PDO mapping	NO	
Backup	NO	

Bit	RW	Description
255...[SI0]	W	SDO abort with codes 0x06090030 (value range of parameter exceeded) or 0x06090031 (value of parameter too high)
6...[SI0]	W	SI3 = written value without checking
5...1	W	The Slave returns SDO abort with codes 0x06090030 (value range of parameter exceeded) or 0x06090032 (value of parameter too low)
0	R	When the message queue will be overwritten, the Slave sets SI3 to "0" (zero)
	W	The Slave will clear all messages

Table 6-65 Newest acknowledged message – Read/Write bits

### 6.2.12.4 *New messages available*

Name	New messages available	
Index	0x10F3	
Subindex	0x04	
Data type	BOOLEAN	
Access type	RO	
Default value	0	
Value range	0 (newest message was read)	1 (newest message was not read)
PDO mapping	YES	
Backup	NO	

**6.2.12.5 Flags**

Flags the diagnosis messages for sending/storing. The ESI/SII describes the functionality supported by the Slave. If the Master writes an unsupported value, the Slave returns 0x06090030 (value range of parameter exceeded).

Name	Flags	
Index	0x10F3	
Subindex	0x05	
Data type	UNSIGNED16	
Access type	RW	
Default value	0	
Value range	0	15
PDO mapping	NO	
Backup	NO	

Bit		RW	Description
15...6	–	–	reserved
5	1	RO	<ul style="list-style-type: none"> <li>In Overwrite Mode: Unacknowledged messages have been overwritten; SI3 is set to “0” (zero)</li> <li>In Acknowledge Mode: Buffer is full with unacknowledged messages, new messages are discarded</li> </ul>
4	0	(W)	Overwrite Mode – old messages are overwritten if buffer is full
	1		Acknowledge Mode – new messages only overwrites older ones if before acknowledged
3	0	(W)	Error messages are stored in the diagnosis message queue
	1		Error messages will not be stored in the diagnosis message queue
2	0	W	Warning messages are stored in the diagnosis message queue
	1		Warning messages will not be stored in the diagnosis message queue
1	0	W	Info messages are stored in the diagnosis message queue
	1		Info messages will not be stored in the diagnosis message queue
0	0	(W)	Default if device does not support Emergency Sending
	1		New diagnosis messages are sent as Emergency Message

Table 6-66 Flags – Read/Write bits

### 6.2.12.6 *Diagnosis message*

The buffer can store up to 5 diagnosis messages. The first message is stored in subindex 6, the next in subindex 7, and so on. Once the diagnosis message queue is full, the Slave overwrites subindex 6, then subindex 7, and so on, thus enabling the Master to access the most recent messages).

Namedw	Diagnosis message 1 Diagnosis message 2 Diagnosis message 3 Diagnosis message 4 Diagnosis message 5	
Index	0x10F3	
Subindex	0x06...0x0A	
Data type	OCTET_STRING	
Access type	RO	
Default value	-	
Value range	-	-
PDO mapping	NO	
Backup	NO	

## 6.2.13 SDO server parameter

THE OBJECT IS ONLY AVAILABLE FOR «IDX CANOPEN».

Name	SDO server parameter
Index	0x1200
Object code	RECORD
Highest subindex supported	2

### 6.2.13.1 COB-ID SDO client to server

Shows the Communication Object Identifier for service data objects from master to device.

Related objects: → “Producer heartbeat time” on page 6-69

Name	COB-ID SDO client to server
Index	0x1200
Subindex	0x01
Data type	UNSIGNED32
Access type	RO
Default value	0x00000600 + Node-ID
Value range	–
PDO mapping	NO
Backup	NO

### 6.2.13.2 COB-ID SDO server to client

Shows the Communication Object Identifier for service data objects from device to master.

Related objects: → “Node-ID” on page 6-121

Name	COB-ID SDO server to client
Index	0x1200
Subindex	0x02
Data type	UNSIGNED32
Access type	RO
Default value	0x00000580 + Node-ID
Value range	–
PDO mapping	NO
Backup	NO

## 6.2.14 Receive PDO 1 parameter

THE OBJECT IS ONLY AVAILABLE FOR «IDX CANOPEN».

Name	Receive PDO 1 parameter
Index	0x1400
Object code	RECORD
Highest subindex supported	2

### 6.2.14.1 COB-ID used by RxPDO 1

The Communication Object Identifier of receive process data object.

Name	COB-ID used by RxPDO 1
Index	0x1400
Subindex	0x01
Data type	UNSIGNED32
Access type	RW
Default value	0x00000200 + Node-ID
Value range	→ Table 6-67 and Table 6-68
PDO mapping	NO
Backup	YES

Bit 31	Bit 30	Bit 29...11	Bit 10...0
valid	RTR	0 (CAN base frame)	11-bit CAN ID

Table 6-67 COB-ID used by RxPDO – Structure

Bit	Description	
valid	0b	PDO exists / PDO is valid
	1b	PDO does not exist / PDO is not valid
RTR	0b	RTR allowed on this PDO
	1b	no RTR allowed on this PDO
11-bit Can ID	Value range	0x181...0x57F 0x000 (if valid = 1)

Table 6-68 COB-ID used by RxPDO – Description



**6.2.14.2** *Transmission type RxPDO 1*

Describes the PDO's communication principle.

Name	Transmission type RxPDO 1	
Index	0x1400	
Subindex	0x02	
Data type	UNSIGNED8	
Access type	RW	
Default value	255	
Value range	1:synchronous 255:asynchronous	-
PDO mapping	NO	
Backup	YES	

## 6.2.15 Receive PDO 2 parameter

THE OBJECT IS ONLY AVAILABLE FOR «IDX CANOPEN».

Name	Receive PDO 2 parameter
Index	0x1401
Object code	RECORD
Highest subindex supported	2

### 6.2.15.1 COB-ID used by RxPDO 2

The Communication Object Identifier of receive process data object.

Name	COB-ID used by RxPDO 2
Index	0x1401
Subindex	0x01
Data type	UNSIGNED32
Access type	RW
Default value	0x00000300 + Node-ID
Value range	→ Table 6-67 and Table 6-68
PDO mapping	NO
Backup	YES

### 6.2.15.2 Transmission type RxPDO 2

Describes the PDO's communication principle.

Name	Transmission type RxPDO 2	
Index	0x1401	
Subindex	0x02	
Data type	UNSIGNED8	
Access type	RW	
Default value	255	
Value range	1:synchronous 255:asynchronous	–
PDO mapping	NO	
Backup	YES	

## 6.2.16 Receive PDO 3 parameter

THE OBJECT IS ONLY AVAILABLE FOR «IDX CANOPEN».

Name	Receive PDO 3 parameter
Index	0x1402
Object code	RECORD
Highest subindex supported	2

### 6.2.16.1 COB-ID used by RxPDO 3

The Communication Object Identifier of receive process data object.

Name	COB-ID used by RxPDO 3
Index	0x1402
Subindex	0x01
Data type	UNSIGNED32
Access type	RW
Default value	0x00000400 + Node-ID
Value range	→ Table 6-67 and Table 6-68
PDO mapping	NO
Backup	YES

### 6.2.16.2 Transmission type RxPDO 3

Describes the PDO's communication principle.

Name	Transmission type RxPDO 3
Index	0x1402
Subindex	0x02
Data type	UNSIGNED8
Access type	RW
Default value	255
Value range	1:synchronous 255:asynchronous
PDO mapping	NO
Backup	YES

## 6.2.17 Receive PDO 4 parameter

THE OBJECT IS ONLY AVAILABLE FOR «IDX CANOPEN».

Name	Receive PDO 4 parameter
Index	0x1403
Object code	RECORD
Highest subindex supported	2

### 6.2.17.1 COB-ID used by RxPDO 4

The Communication Object Identifier of receive process data object.

Name	COB-ID used by RxPDO 4
Index	0x1403
Subindex	0x01
Data type	UNSIGNED32
Access type	RW
Default value	0x00000500 + Node-ID
Value range	→ Table 6-67 and Table 6-68
PDO mapping	NO
Backup	YES

### 6.2.17.2 Transmission type RxPDO 4

Describes the PDO's communication principle.

Name	Transmission type RxPDO 4	
Index	0x1403	
Subindex	0x02	
Data type	UNSIGNED8	
Access type	RW	
Default value	255	
Value range	1:synchronous 255:asynchronous	–
PDO mapping	NO	
Backup	YES	

## 6.2.18 Receive PDO 1 mapping

**THE OBJECT IS ONLY AVAILABLE FOR «IDX CANOPEN» AND «IDX ETHERCAT».**

Contains the process data mapping parameters of RxPDO1. Mapping of objects is required to enable PDO processing. Subindex 0 represents the number of mapped objects. Subindex 0x01...0x0C represent the mapped objects whereby the value describes the corresponding index, subindex, and length. The value for the length (in bits) is used to calculate the total mapping length. The maximal allowed length for all mapped objects is as follows:

- CANopen 8 Byte
- EtherCAT 40 Byte

Write access is only permitted in NMT state «Pre-Operational».

The structure for the mapped object in subindex 0x01...0x0C is as follows:

Bit 31...16	Bit 15...8	Bit 7...0
Index	Subindex	Length

Table 6-69 Receive PDO mapping – Structure of mapped object

To be able to change the PDO mapping, the following procedure must be performed:

- Write the value "0" (zero) to subindex 0x00 (disable PDO).
- Modify the desired objects in subindex 0x01...0x0n.
- Write the desired number of mapped objects to subindex 0x00.

Name	Receive PDO 1 mapping
Index	0x1600
Object code	RECORD
Highest subindex supported	12

### 6.2.18.1 Number of mapped objects in RxPDO 1

Name	Number of mapped objects in RxPDO 1	
Index	0x1600	
Subindex	0x00	
Data type	UNSIGNED8	
Access type	RW	
Default value	1	
Value range	0 (PDO disabled)	1...12 (1...12 objects are mapped)
PDO mapping	NO	
Backup	YES	

### 6.2.18.2 1st mapped object in RxPDO 1

Objects with subindex 0x02...0x0C follow the same description as the object with subindex 1.

Name	1st mapped object in RxPDO 1	
Index	0x1600	
Subindex	0x01	
Data type	UNSIGNED32	
Access type	RW	
Default value	0x60400010	
Value range	–	–
PDO mapping	NO	
Backup	YES	

#### DEFAULT VALUES FOR MAPPED OBJECTS IN RXPDO1

Mapped object	Subindex	Default value	
1 <sup>st</sup>	0x01	0x60400010	→Controlword
2 <sup>nd</sup>	0x02	0x00000000	no object mapped
3 <sup>rd</sup>	0x03	0x00000000	no object mapped
4 <sup>th</sup>	0x04	0x00000000	no object mapped
5 <sup>th</sup>	0x05	0x00000000	no object mapped
6 <sup>th</sup>	0x06	0x00000000	no object mapped
7 <sup>th</sup>	0x07	0x00000000	no object mapped
8 <sup>th</sup>	0x08	0x00000000	no object mapped
9 <sup>th</sup>	0x09	0x00000000	no object mapped
10 <sup>th</sup>	0x0A	0x00000000	no object mapped
11 <sup>th</sup>	0x0B	0x00000000	no object mapped
12 <sup>th</sup>	0x0C	0x00000000	no object mapped

Table 6-70 Receive PDO 1 mapping

## 6.2.19 Receive PDO 2 mapping

**THE OBJECT IS ONLY AVAILABLE FOR «IDX CANOPEN» AND «IDX ETHERCAT».**

Contains the process data mapping parameters of RxPDO2. For a detailed description applicable by analogy → “Receive PDO 1 mapping” on page 6-81.

Name	Receive PDO 2 mapping
Index	0x1601
Object code	RECORD
Highest subindex supported	12

### 6.2.19.1 Number of mapped objects in RxPDO 2

Name	Number of mapped objects in RxPDO 2	
Index	0x1601	
Subindex	0x00	
Data type	UNSIGNED8	
Access type	RW	
Default value	2	
Value range	0 (PDO disabled)	1...12 (1...12 objects are mapped)
PDO mapping	NO	
Backup	YES	

### 6.2.19.2 1st mapped object in RxPDO 2

Objects with subindex 0x02...0x12 follow the same description as the object with subindex 1.

Name	1st mapped object in RxPDO 2	
Index	0x1601	
Subindex	0x01	
Data type	UNSIGNED32	
Access type	RW	
Default value	0x60400010	
Value range	–	–
PDO mapping	NO	
Backup	YES	

#### DEFAULT VALUES FOR MAPPED OBJECTS IN RXPDO2

Mapped object	Subindex	Default value	
1 <sup>st</sup>	0x01	0x60400010	→Controlword
2 <sup>nd</sup>	0x02	0x60600008	→Modes of operation
3 <sup>rd</sup>	0x03	0x00000000	no object mapped
4 <sup>th</sup>	0x04	0x00000000	no object mapped
5 <sup>th</sup>	0x05	0x00000000	no object mapped
6 <sup>th</sup>	0x06	0x00000000	no object mapped
7 <sup>th</sup>	0x07	0x00000000	no object mapped
8 <sup>th</sup>	0x08	0x00000000	no object mapped
9 <sup>th</sup>	0x09	0x00000000	no object mapped
10 <sup>th</sup>	0x0A	0x00000000	no object mapped
11 <sup>th</sup>	0x0B	0x00000000	no object mapped
12 <sup>th</sup>	0x0C	0x00000000	no object mapped

Table 6-71 Receive PDO 2 mapping



## 6.2.20 Receive PDO 3 mapping

**THE OBJECT IS ONLY AVAILABLE FOR «IDX CANOPEN» AND «IDX ETHERCAT».**

Contains the process data mapping parameters of RxPDO3. For a detailed description applicable by analogy → “Receive PDO 1 mapping” on page 6-81.

Name	Receive PDO 3 mapping
Index	0x1602
Object code	RECORD
Highest subindex supported	12

### 6.2.20.1 Number of mapped objects in RxPDO 3

Name	Number of mapped objects in RxPDO 3	
Index	0x1602	
Subindex	0x00	
Data type	UNSIGNED8	
Access type	RW	
Default value	2	
Value range	0 (PDO disabled)	1...12 (1...12 objects are mapped)
PDO mapping	NO	
Backup	YES	

### 6.2.20.2 1st mapped object in RxPDO 3

Objects with subindex 0x02...0x12 follow the same description as the object with subindex 1.

Name	1st mapped object in RxPDO 3	
Index	0x1602	
Subindex	0x01	
Data type	UNSIGNED32	
Access type	RW	
Default value	0x60400010	
Value range	–	–
PDO mapping	NO	
Backup	YES	

#### DEFAULT VALUES FOR MAPPED OBJECTS IN RXPDO3

Mapped object	Subindex	Default value	
1 <sup>st</sup>	0x01	0x60400010	→Controlword
2 <sup>nd</sup>	0x02	0x607A0020	→Target position
3 <sup>rd</sup>	0x03	0x00000000	no object mapped
4 <sup>th</sup>	0x04	0x00000000	no object mapped
5 <sup>th</sup>	0x05	0x00000000	no object mapped
6 <sup>th</sup>	0x06	0x00000000	no object mapped
7 <sup>th</sup>	0x07	0x00000000	no object mapped
8 <sup>th</sup>	0x08	0x00000000	no object mapped
9 <sup>th</sup>	0x09	0x00000000	no object mapped
10 <sup>th</sup>	0x0A	0x00000000	no object mapped
11 <sup>th</sup>	0x0B	0x00000000	no object mapped
12 <sup>th</sup>	0x0C	0x00000000	no object mapped

Table 6-72 Receive PDO 3 mapping

## 6.2.21 Receive PDO 4 mapping

**THE OBJECT IS ONLY AVAILABLE FOR «IDX CANOPEN» AND «IDX ETHERCAT».**

Contains the process data mapping parameters of RxPDO4. For a detailed description applicable by analogy → “Receive PDO 1 mapping” on page 6-81.

Name	Receive PDO 4 mapping
Index	0x1603
Object code	RECORD
Highest subindex supported	12

### 6.2.21.1 Number of mapped objects in RxPDO 4

Name	Number of mapped objects in RxPDO 4	
Index	0x1603	
Subindex	0x00	
Data type	UNSIGNED8	
Access type	RW	
Default value	2	
Value range	0 (PDO disabled)	1...12 (1...12 objects are mapped)
PDO mapping	NO	
Backup	YES	

### 6.2.21.2 1st mapped object in RxPDO 4

Objects with subindex 0x02...0x12 follow the same description as the object with subindex 1.

Name	1st mapped object in RxPDO 4	
Index	0x1603	
Subindex	0x01	
Data type	UNSIGNED32	
Access type	RW	
Default value	0x60400010	
Value range	–	–
PDO mapping	NO	
Backup	YES	

#### DEFAULT VALUES FOR MAPPED OBJECTS IN RXPDO4

Mapped object	Subindex	Default value	
1 <sup>st</sup>	0x01	0x60400010	→Controlword
2 <sup>nd</sup>	0x02	0x60FF0020	→Target velocity
3 <sup>rd</sup>	0x03	0x00000000	no object mapped
4 <sup>th</sup>	0x04	0x00000000	no object mapped
5 <sup>th</sup>	0x05	0x00000000	no object mapped
6 <sup>th</sup>	0x06	0x00000000	no object mapped
7 <sup>th</sup>	0x07	0x00000000	no object mapped
8 <sup>th</sup>	0x08	0x00000000	no object mapped
9 <sup>th</sup>	0x09	0x00000000	no object mapped
10 <sup>th</sup>	0x0A	0x00000000	no object mapped
11 <sup>th</sup>	0x0B	0x00000000	no object mapped
12 <sup>th</sup>	0x0C	0x00000000	no object mapped

Table 6-73 Receive PDO 4 mapping

## 6.2.22 Transmit PDO 1 parameter

THE OBJECT IS ONLY AVAILABLE FOR «IDX CANOPEN».

Name	Transmit PDO 1 parameter
Index	0x1800
Object code	RECORD
Highest subindex supported	3

### 6.2.22.1 COB-ID used by TxPDO 1

The Communication Object Identifier of transmit process data object.

Name	COB-ID used by TxPDO 1
Index	0x1800
Subindex	0x01
Data type	UNSIGNED32
Access type	RW
Default value	0x40000180 + Node-ID
Value range	→ Table 6-74 and Table 6-75
PDO mapping	NO
Backup	YES

Bit 31	Bit 30	Bit 29...11	Bit 10...0
valid	RTR	0 (CAN base frame)	11-bit CAN ID

Table 6-74 COB-ID used by TxPDO – Structure

Bit	Description	
valid	0b	PDO exists / PDO is valid
	1b	PDO does not exist / PDO is not valid
RTR	0b	RTR allowed on this PDO
	1b	no RTR allowed on this PDO
11-bit Can ID	11-bit CAN ID of the CAN base frame	
	Value range	0x181...0x57F 0x000 (if valid = 1)

Table 6-75 COB-ID used by TxPDO – Description

### 6.2.22.2 *Transmission type TxPDO 1*

Describes the PDO's communication principle.

With transmission type 253, the PDO is only transmitted on remote transmission request (RTR). With transmission type 255, the PDO is transmitted if the data changes its value. Therefore, the inhibit time defines a minimum interval.

Name	Transmission type TxPDO 1	
Index	0x1800	
Subindex	0x02	
Data type	UNSIGNED8	
Access type	RW	
Default value	255	
Value range	1: synchronous 253: asynchronous on RTR only 255: asynchronous	–
PDO mapping	NO	
Backup	YES	

### 6.2.22.3 *Inhibit time TxPDO 1*

Represents the minimum interval for event-triggered PDO transmission. The value is defined as multiple of 100  $\mu$ s.

Event-triggered PDOs can generate immense loads on both CAN bus and device especially if the inhibit time of different PDOs is set to a small value.

Name	Inhibit time TxPDO 1	
Index	0x1800	
Subindex	0x03	
Data type	UNSIGNED16	
Access type	RW	
Default value	10	
Value range	–	–
PDO mapping	NO	
Backup	YES	

## 6.2.23 Transmit PDO 2 parameter

THE OBJECT IS ONLY AVAILABLE FOR «IDX CANOPEN».

Name	Transmit PDO 2 parameter
Index	0x1801
Object code	RECORD
Highest subindex supported	3

### 6.2.23.1 COB-ID used by TxPDO 2

The Communication Object Identifier of transmit process data object.

Name	COB-ID used by TxPDO 2
Index	0x1801
Subindex	0x01
Data type	UNSIGNED32
Access type	RW
Default value	0xC0000280 + Node-ID
Value range	→ Table 6-74 and Table 6-75
PDO mapping	NO
Backup	YES

### 6.2.23.2 Transmission type TxPDO 2

Describes the PDO's communication principle.

With transmission type 253, the PDO is only transmitted on remote transmission request (RTR). With transmission type 255, the PDO is transmitted if the data changes its value. Therefore, the inhibit time defines a minimum interval.

Name	Transmission type TxPDO 2
Index	0x1801
Subindex	0x02
Data type	UNSIGNED8
Access type	RW
Default value	255
Value range	1: synchronous 253: asynchronous on RTR only 255: asynchronous
PDO mapping	NO
Backup	YES

### 6.2.23.3 *Inhibit time TxPDO 2*

Represents the minimum interval for event-triggered PDO transmission. The value is defined as multiple of 100  $\mu$ s.

Event-triggered PDOs can generate immense loads on both CAN bus and device especially if the inhibit time of different PDOs is set to a small value.

Name	Inhibit time TxPDO 2	
Index	0x1801	
Subindex	0x03	
Data type	UNSIGNED16	
Access type	RW	
Default value	10	
Value range	–	–
PDO mapping	NO	
Backup	YES	



## 6.2.24 Transmit PDO 3 parameter

THE OBJECT IS ONLY AVAILABLE FOR «IDX CANOPEN».

Name	Transmit PDO 3 parameter
Index	0x1802
Object code	RECORD
Highest subindex supported	3

### 6.2.24.1 COB-ID used by TxPDO 3

The Communication Object Identifier of transmit process data object.

Name	COB-ID used by TxPDO 3
Index	0x1802
Subindex	0x01
Data type	UNSIGNED32
Access type	RW
Default value	0xC0000380 + Node-ID
Value range	→ Table 6-74 and Table 6-75
PDO mapping	NO
Backup	YES

### 6.2.24.2 Transmission type TxPDO 3

Describes the PDO's communication principle.

With transmission type 253, the PDO is only transmitted on remote transmission request (RTR). With transmission type 255, the PDO is transmitted if the data changes its value. Therefore, the inhibit time defines a minimum interval.

Name	Transmission type TxPDO 3	
Index	0x1802	
Subindex	0x02	
Data type	UNSIGNED8	
Access type	RW	
Default value	255	
Value range	1: synchronous 253: asynchronous on RTR only 255: asynchronous	–
PDO mapping	NO	
Backup	YES	

### 6.2.24.3 *Inhibit time TxPDO 3*

Represents the minimum interval for event-triggered PDO transmission. The value is defined as multiple of 100  $\mu$ s.

Event-triggered PDOs can generate immense loads on both CAN bus and device especially if the inhibit time of different PDOs is set to a small value.

Name	Inhibit time TxPDO 3	
Index	0x1802	
Subindex	0x03	
Data type	UNSIGNED16	
Access type	RW	
Default value	10	
Value range	–	–
PDO mapping	NO	
Backup	YES	

## 6.2.25 Transmit PDO 4 parameter

THE OBJECT IS ONLY AVAILABLE FOR «IDX CANOPEN».

Name	Transmit PDO 4 parameter
Index	0x1803
Object code	RECORD
Highest subindex supported	3

### 6.2.25.1 COB-ID used by TxPDO 4

The Communication Object Identifier of transmit process data object.

Name	COB-ID used by TxPDO 4
Index	0x1803
Subindex	0x01
Data type	UNSIGNED32
Access type	RW
Default value	0xC0000480 + Node-ID
Value range	→ Table 6-74 and Table 6-75
PDO mapping	NO
Backup	YES

### 6.2.25.2 Transmission type TxPDO 4

Describes the PDO's communication principle.

With transmission type 253, the PDO is only transmitted on remote transmission request (RTR). With transmission type 255, the PDO is transmitted if the data changes its value. Therefore, the inhibit time defines a minimum interval.

Name	Transmission type TxPDO 4
Index	0x1803
Subindex	0x02
Data type	UNSIGNED8
Access type	RW
Default value	255
Value range	1: synchronous 253: asynchronous on RTR only 255: asynchronous
PDO mapping	NO
Backup	YES

### 6.2.25.3 *Inhibit time TxPDO 4*

Represents the minimum interval for event-triggered PDO transmission. The value is defined as multiple of 100  $\mu$ s.

Event-triggered PDOs can generate immense loads on both CAN bus and device especially if the inhibit time of different PDOs is set to a small value.

Name	Inhibit time TxPDO 4	
Index	0x1803	
Subindex	0x03	
Data type	UNSIGNED16	
Access type	RW	
Default value	10	
Value range	–	–
PDO mapping	NO	
Backup	YES	

## 6.2.26 Transmit PDO 1 mapping

**THE OBJECT IS ONLY AVAILABLE FOR «IDX CANOPEN» AND «IDX ETHERCAT».**

Contains the process data mapping parameters of TxPDO1. Mapping of objects is required to enable PDO processing. Subindex 0 represents the number of mapped objects. Subindex 0x01...0x0C represent the mapped objects whereby the value describes the corresponding index, subindex, and length. The value for the length (in bits) is used to calculate the total mapping length.

The maximal allowed length for all mapped objects is as follows:

- CANopen 8 Byte
- EtherCAT 40 Byte

Write access is only permitted in NMT state «Pre-Operational».

The structure for the mapped object in subindex 0x01...0x0C is as follows:

Bit 31...16	Bit 15...8	Bit 7...0
Index	Subindex	Length

Table 6-76 Transmit PDO mapping – Structure of mapped object

To be able to change the PDO mapping, the following procedure must be performed:

- a) Write the value “0” (zero) to subindex 0x00 (disable PDO).
- b) Modify the desired objects in subindex 0x01...0x0n.
- c) Write the desired number of mapped objects to subindex 0x00.

Name	Transmit PDO 1 mapping
Index	0x1A00
Object code	RECORD
Highest subindex supported	12

### 6.2.26.1 Number of mapped objects in TxPDO 1

Name	Number of mapped objects in TxPDO 1	
Index	0x1A00	
Subindex	0x00	
Data type	UNSIGNED8	
Access type	RW	
Default value	1	
Value range	0 (PDO disabled)	1...12 (1...12 objects are mapped)
PDO mapping	NO	
Backup	YES	

### 6.2.26.2 1st mapped object in TxPDO 1

Objects with subindex 0x02...0x0C follow the same description as the object with subindex 1.

Name	1st mapped object in TxPDO 1	
Index	0x1A00	
Subindex	0x01	
Data type	UNSIGNED32	
Access type	RW	
Default value	0x60410010	
Value range	–	–
PDO mapping	NO	
Backup	YES	

#### DEFAULT VALUES FOR MAPPED OBJECTS IN TXPDO1

Mapped object	Subindex	Default value	
1 <sup>st</sup>	0x01	0x60410010	→ Statusword
2 <sup>nd</sup>	0x02	0x00000000	no object mapped
3 <sup>rd</sup>	0x03	0x00000000	no object mapped
4 <sup>th</sup>	0x04	0x00000000	no object mapped
5 <sup>th</sup>	0x05	0x00000000	no object mapped
6 <sup>th</sup>	0x06	0x00000000	no object mapped
7 <sup>th</sup>	0x07	0x00000000	no object mapped
8 <sup>th</sup>	0x08	0x00000000	no object mapped
9 <sup>th</sup>	0x09	0x00000000	no object mapped
10 <sup>th</sup>	0x0A	0x00000000	no object mapped
11 <sup>th</sup>	0x0B	0x00000000	no object mapped
12 <sup>th</sup>	0x0C	0x00000000	no object mapped

Table 6-77 Transmit PDO 1 mapping

## 6.2.27 Transmit PDO 2 mapping

**THE OBJECT IS ONLY AVAILABLE FOR «IDX CANOPEN» AND «IDX ETHERCAT».**

Contains the process data mapping parameters of TxPDO2. For a detailed description applicable by analogy → “Transmit PDO 1 mapping” on page 6-97.

Name	Transmit PDO 2 mapping
Index	0x1A01
Object code	RECORD
Highest subindex supported	12

### 6.2.27.1 Number of mapped objects in TxPDO 2

Name	Number of mapped objects in TxPDO 2	
Index	0x1A01	
Subindex	0x00	
Data type	UNSIGNED8	
Access type	RW	
Default value	2	
Value range	0 (PDO disabled)	1...12 (1...12 objects are mapped)
PDO mapping	NO	
Backup	YES	

### 6.2.27.2 1st mapped object in TxPDO 2

Objects with subindex 0x02...0x0C follow the same description as the object with subindex 1.

Name	1st mapped object in TxPDO 2	
Index	0x1A01	
Subindex	0x01	
Data type	UNSIGNED32	
Access type	RW	
Default value	0x60410010	
Value range	–	–
PDO mapping	NO	
Backup	YES	

#### DEFAULT VALUES FOR MAPPED OBJECTS IN TXPDO2

Mapped object	Subindex	Default value	
1 <sup>st</sup>	0x01	0x60410010	→ Statusword
2 <sup>nd</sup>	0x02	0x60610008	→ Modes of operation display
3 <sup>rd</sup>	0x03	0x00000000	no object mapped
4 <sup>th</sup>	0x04	0x00000000	no object mapped
5 <sup>th</sup>	0x05	0x00000000	no object mapped
6 <sup>th</sup>	0x06	0x00000000	no object mapped
7 <sup>th</sup>	0x07	0x00000000	no object mapped
8 <sup>th</sup>	0x08	0x00000000	no object mapped
9 <sup>th</sup>	0x09	0x00000000	no object mapped
10 <sup>th</sup>	0x0A	0x00000000	no object mapped
11 <sup>th</sup>	0x0B	0x00000000	no object mapped
12 <sup>th</sup>	0x0C	0x00000000	no object mapped

Table 6-78 Transmit PDO 2 mapping



## 6.2.28 Transmit PDO 3 mapping

**THE OBJECT IS ONLY AVAILABLE FOR «IDX CANOPEN» AND «IDX ETHERCAT».**

Contains the process data mapping parameters of TxPDO3. For a detailed description applicable by analogy → “Transmit PDO 1 mapping” on page 6-97.

Name	Transmit PDO 3 mapping
Index	0x1A02
Object code	RECORD
Highest subindex supported	12

### 6.2.28.1 Number of mapped objects in TxPDO 3

Name	Number of mapped objects in TxPDO 3	
Index	0x1A02	
Subindex	0x00	
Data type	UNSIGNED8	
Access type	RW	
Default value	2	
Value range	0 (PDO disabled)	1...12 (1...12 objects are mapped)
PDO mapping	NO	
Backup	YES	

### 6.2.28.2 1st mapped object in TxPDO 3

Objects with subindex 0x02...0x0C follow the same description as the object with subindex 1.

Name	1st mapped object in TxPDO 3	
Index	0x1A02	
Subindex	0x01	
Data type	UNSIGNED32	
Access type	RW	
Default value	0x60410010	
Value range	–	–
PDO mapping	NO	
Backup	YES	

#### DEFAULT VALUES FOR MAPPED OBJECTS IN TXPDO3

Mapped object	Subindex	Default value	
1 <sup>st</sup>	0x01	0x60410010	→ Statusword
2 <sup>nd</sup>	0x02	0x60640020	→ Position actual value
3 <sup>rd</sup>	0x03	0x00000000	no object mapped
4 <sup>th</sup>	0x04	0x00000000	no object mapped
5 <sup>th</sup>	0x05	0x00000000	no object mapped
6 <sup>th</sup>	0x06	0x00000000	no object mapped
7 <sup>th</sup>	0x07	0x00000000	no object mapped
8 <sup>th</sup>	0x08	0x00000000	no object mapped
9 <sup>th</sup>	0x09	0x00000000	no object mapped
10 <sup>th</sup>	0x0A	0x00000000	no object mapped
11 <sup>th</sup>	0x0B	0x00000000	no object mapped
12 <sup>th</sup>	0x0C	0x00000000	no object mapped

Table 6-79 Transmit PDO 3 mapping

## 6.2.29 Transmit PDO 4 mapping

**THE OBJECT IS ONLY AVAILABLE FOR «IDX CANOPEN» AND «IDX ETHERCAT».**

Contains the process data mapping parameters of TxPDO4. For a detailed description applicable by analogy → “Transmit PDO 1 mapping” on page 6-97.

Name	Transmit PDO 4 mapping
Index	0x1A03
Object code	RECORD
Highest subindex supported	12

### 6.2.29.1 Number of mapped objects in TxPDO 4

Name	Number of mapped objects in TxPDO 4	
Index	0x1A03	
Subindex	0x00	
Data type	UNSIGNED8	
Access type	RW	
Default value	2	
Value range	0 (PDO disabled)	1...12 (1...12§ objects are mapped)
PDO mapping	NO	
Backup	YES	

### 6.2.29.2 1st mapped object in TxPDO 4

Objects with subindex 0x02...0x0C follow the same description as the object with subindex 1.

Name	1st mapped object in TxPDO 4	
Index	0x1A03	
Subindex	0x01	
Data type	UNSIGNED32	
Access type	RW	
Default value	0x60410010	
Value range	–	–
PDO mapping	NO	
Backup	YES	

#### DEFAULT VALUES FOR MAPPED OBJECTS IN TXPDO4

Mapped object	Subindex	Default value	
1 <sup>st</sup>	0x01	0x60410010	→ Statusword
2 <sup>nd</sup>	0x02	0x606C0020	→ Velocity actual value
3 <sup>rd</sup>	0x03	0x00000000	no object mapped
4 <sup>th</sup>	0x04	0x00000000	no object mapped
5 <sup>th</sup>	0x05	0x00000000	no object mapped
6 <sup>th</sup>	0x06	0x00000000	no object mapped
7 <sup>th</sup>	0x07	0x00000000	no object mapped
8 <sup>th</sup>	0x08	0x00000000	no object mapped
9 <sup>th</sup>	0x09	0x00000000	no object mapped
10 <sup>th</sup>	0x0A	0x00000000	no object mapped
11 <sup>th</sup>	0x0B	0x00000000	no object mapped
12 <sup>th</sup>	0x0C	0x00000000	no object mapped

Table 6-80 Transmit PDO 4 mapping

### 6.2.30 SYNC manager communication type

**THE OBJECT IS ONLY AVAILABLE FOR «IDX ETHERCAT».**

The preconfigured read only object is used to read out the transfer mode of the EtherCAT Sync Manager's channels.

Name	SYNC manager communication type
Index	0x1C00
Object code	ARRAY
Highest subindex supported	4

#### 6.2.30.1 Number of used SYNC manager channels

Name	Number of used SYNC manager channels	
Index	0x1C00	
Subindex	0x00	
Data type	UNSIGNED8	
Access type	RO	
Default value	4	
Value range	4	4
PDO mapping	NO	
Backup	NO	

#### 6.2.30.2 Communication type SYNC channel 0

Name	Communication type SYNC channel 0	
Index	0x1C00	
Subindex	0x01	
Data type	UNSIGNED8	
Access type	RO	
Default value	1: Mailbox Receive (Master → Slave)	
Value range	1	1
PDO mapping	NO	
Backup	NO	

#### 6.2.30.3 Communication type SYNC channel 1

Name	Communication type SYNC channel 1	
Index	0x1C00	
Subindex	0x02	
Data type	UNSIGNED8	
Access type	RO	
Default value	2: Mailbox Receive (Master ← Slave)	
Value range	2	2
PDO mapping	NO	
Backup	NO	

#### 6.2.30.4 *Communication type SYNC channel 2*

Name	Communication type SYNC channel 2	
Index	0x1C00	
Subindex	0x03	
Data type	UNSIGNED8	
Access type	RO	
Default value	3: Process Data Output (Master → Slave)	
Value range	3	3
PDO mapping	NO	
Backup	NO	

#### 6.2.30.5 *Communication type SYNC channel 3*

Name	Communication type SYNC channel 3	
Index	0x1C00	
Subindex	0x04	
Data type	UNSIGNED8	
Access type	RO	
Default value	4: Process Data Output (Master ← Slave)	
Value range	4	4
PDO mapping	NO	
Backup	NO	

### 6.2.31 SYNC manager 2 PDO assignment

**THE OBJECT IS ONLY AVAILABLE FOR «IDX ETHERCAT».**

Used to configure a PDO assignment for Sync channel 2 (Master → Slave).

In order to change the value in object → 1st assigned RxPDO, object → Number of assigned RxPDOs must be set to zero first.

Write access is only permitted in NMT state «Pre-Operational».

Name	SYNC manager 2 PDO assignment
Index	0x1C12
Object code	ARRAY
Highest subindex supported	1

#### 6.2.31.1 Number of assigned RxPDOs

Name	Number of assigned RxPDOs
Index	0x1C12
Subindex	0x00
Data type	UNSIGNED8
Access type	RW
Default value	1
Value range	0 (PDO disabled) 1
PDO mapping	NO
Backup	YES

#### 6.2.31.2 1st assigned RxPDO

Name	1st assigned RxPDO
Index	0x1C12
Subindex	0x01
Data type	UNSIGNED16
Access type	RW
Default value	0x1600
Value range	0x1600 0x1603
PDO mapping	NO
Backup	YES

## 6.2.32 SYNC manager 3 PDO assignment

**THE OBJECT IS ONLY AVAILABLE FOR «IDX ETHERCAT».**

Used to configure a PDO assignment for Sync channel 2 (Master ← Slave).

In order to change the value in object →1st assigned TxPDO, object →Number of assigned TxPDOs must be set to zero first.

Write access is only permitted in NMT state «Pre-Operational».

Name	SYNC manager 3 PDO assignment
Index	0x1C13
Object code	ARRAY
Highest subindex supported	1

### 6.2.32.1 Number of assigned TxPDOs

Name	Number of assigned TxPDOs
Index	0x1C13
Subindex	0x00
Data type	UNSIGNED8
Access type	RW
Default value	1
Value range	0 (PDO disabled) 1
PDO mapping	NO
Backup	YES

### 6.2.32.2 1st assigned TxPDO

Name	1st assigned TxPDO
Index	0x1C13
Subindex	0x01
Data type	UNSIGNED16
Access type	RW
Default value	0x1A00
Value range	0x1A00 0x1A03
PDO mapping	NO
Backup	YES



### 6.2.33 SYNC manager 2 parameter

**THE OBJECT IS ONLY AVAILABLE FOR «IDX ETHERCAT».**

Used to display the synchronization of the output parameters.

Name	SYNC manager 2 parameter
Index	0x1C32
Object code	RECORD
Highest subindex supported	12

#### 6.2.33.1 Synchronization type

Displays the synchronization type of the output parameters.

Name	Synchronization type
Index	0x1C32
Subindex	0x01
Data type	UNSIGNED16
Access type	RO
Default value	Synchronous
Value range	→ Table 6-81
PDO mapping	NO
Backup	NO

Value	Description
0x0001	Synchronous: Synchronous (with SM2 event)
0x0002	Distributed clock Sync0: Synchronous with SYNC0 event

Table 6-81 SYNC mode output parameters

#### 6.2.33.2 Cycle time

Displays the cycle time of the output parameters. In Sync Manager synchronous mode, the value is measured while in Distributed Clock synchronous mode, the value is taken from the SyncO cycle time register. The value is given in [ns].

Name	Cycle time
Index	0x1C32
Subindex	0x02
Data type	UNSIGNED32
Access type	RO
Default value	–
Value range	–
PDO mapping	NO
Backup	NO

### 6.2.33.3 Synchronization types supported

Displays the supported synchronization modes of the output parameters.

Name	Synchronization types supported	
Index	0x1C32	
Subindex	0x04	
Data type	UNSIGNED16	
Access type	RO	
Default value	0x0406 (→Table 6-82)	
Value range	–	–
PDO mapping	NO	
Backup	NO	

Bit	Description
15...12	reserved
11	Fixed delay time (synchronization executed by hardware)
10...7	reserved
6, 5	Shift settings 00 = No output shift supported
4...2	DC mode supported 000 = No DC 001 = DC Sync0
1	Synchronous supported
0	FreeRun supported

Table 6-82 Synchronization types supported – Output parameters

### 6.2.33.4 Minimum cycle time

Displays the minimum cycle time of the output parameters. The value is given in [ns].

Name	Minimum cycle time	
Index	0x1C32	
Subindex	0x05	
Data type	UNSIGNED32	
Access type	RO	
Default value	1'000'000	
Value range	–	–
PDO mapping	NO	
Backup	NO	

**6.2.33.5 Calc and copy time**

The time needed by the application controller to copy the process data from the Sync Manager to the local memory and to perform calculations, if necessary, before the data is sent to the process. The value is given in [ns].

Name	Calc and copy time	
Index	0x1C32	
Subindex	0x06	
Data type	UNSIGNED32	
Access type	RO	
Default value	1'000	
Value range	–	–
PDO mapping	NO	
Backup	NO	

**6.2.33.6 Delay time**

The hardware delay time of the slave. The time from receiving the trigger (Sync0 or Sync1 Event) to drive output values to the time until they become valid in the process. The value is given in [ns].

Name	Delay time	
Index	0x1C32	
Subindex	0x09	
Data type	UNSIGNED32	
Access type	RO	
Default value	1'000	
Value range	–	–
PDO mapping	NO	
Backup	NO	

**6.2.33.7 SM-event missed**

The SM-event missed counter.

Name	SM-event missed	
Index	0x1C32	
Subindex	0x0B	
Data type	UNSIGNED16	
Access type	RO	
Default value	0	
Value range	–	–
PDO mapping	NO	
Backup	NO	

### 6.2.33.8 *Cycle time too small*

The cycle time too small/even counter.

Name	Cycle time too small	
Index	0x1C32	
Subindex	0x0C	
Data type	UNSIGNED16	
Access type	RO	
Default value	0	
Value range	–	–
PDO mapping	NO	
Backup	NO	

## 6.2.34 SYNC manager 3 parameter

**THE OBJECT IS ONLY AVAILABLE FOR «IDX ETHERCAT».**

Used to display the synchronization of the input parameters.

Name	SYNC manager 3 parameter
Index	0x1C33
Object code	RECORD
Highest subindex supported	12

### 6.2.34.1 Synchronization type

Displays the synchronization type of the input parameters.

Name	Synchronization type
Index	0x1C33
Subindex	0x01
Data type	UNSIGNED16
Access type	RO
Default value	Synchronous with SM2
Value range	→ Table 6-83
PDO mapping	NO
Backup	NO

Value	Description
0x0002	Distributed clock Sync0: Synchronous with SYNC0 event
0x0022	Synchronous with SM2: Synchronous with SM2 event

Table 6-83 SYNC mode input parameters

### 6.2.34.2 Cycle time

Displays the cycle time of the input parameters. In Sync Manager synchronous mode, the value is measured while in Distributed Clock synchronous mode, the value is taken from the SyncO cycle time register. The value is given in [ns].

Name	Cycle time
Index	0x1C33
Subindex	0x02
Data type	UNSIGNED32
Access type	RO
Default value	–
Value range	–
PDO mapping	NO
Backup	NO

**6.2.34.3 Synchronization types supported**

Displays the supported synchronization modes of the input parameters.

Name	Synchronization types supported	
Index	0x1C33	
Subindex	0x04	
Data type	UNSIGNED16	
Access type	RO	
Default value	0x0406 (→ Table 6-84)	
Value range	–	–
PDO mapping	NO	
Backup	NO	

Bit	Description
15...7	reserved
6, 5	Shift settings 00 = No output shift supported
4...2	DC mode supported 000 = No DC 001 = DC Sync0
1	Synchronous supported
0	FreeRun supported

Table 6-84 Synchronization types supported – Input parameters

**6.2.34.4 Minimum cycle time**

Displays the minimum cycle time of the input parameters. The value is given in [ns].

Name	Minimum cycle time	
Index	0x1C33	
Subindex	0x05	
Data type	UNSIGNED32	
Access type	RO	
Default value	1'000'000	
Value range	–	–
PDO mapping	NO	
Backup	NO	

**6.2.34.5 Calc and copy time**

The time needed by the application controller to copy the process data from the Sync Manager to the local memory and to perform calculations, if necessary, before the data is sent to the process. The value is given in [ns].

Name	Calc and copy time	
Index	0x1C33	
Subindex	0x06	
Data type	UNSIGNED32	
Access type	RO	
Default value	1'000	
Value range	–	–
PDO mapping	NO	
Backup	NO	

**6.2.34.6 SM-event missed**

The cycle time too small/even counter. For details.

Name	SM-event missed	
Index	0x1C33	
Subindex	0x0B	
Data type	UNSIGNED16	
Access type	RO	
Default value	0	
Value range	–	–
PDO mapping	NO	
Backup	NO	

**6.2.34.7 Cycle time too small**

The cycle time too small/even counter. For details.

Name	Cycle time too small	
Index	0x1C33	
Subindex	0x0C	
Data type	UNSIGNED16	
Access type	RO	
Default value	0	
Value range	–	–
PDO mapping	NO	
Backup	NO	

### 6.2.35 Program data

Used to download a firmware file (msdc). Download will commence only if both, a stop program command and a clear program command were immediately received by →Program control.

Related objects: →“Program control” on page 6-117

Name	Program data
Index	0x1F50
Object code	ARRAY
Highest subindex supported	1

#### 6.2.35.1 Program number 1

Name	Program number 1
Index	0x1F50
Subindex	0x01
Data type	DOMAIN
Access type	WO
Default value	–
Value range	–
PDO mapping	NO
Backup	NO



## 6.2.36 Program control

Initiates firmware download related commands and reads back information on the running application.

While the bootloader is active, only a subset of objects is supported and only one communication interface can be used. For example: The bootloader is activated with the stop program command. If the first command received by the bootloader is sent by USB, the communication is possible via USB only until the application is started with a start program command or a device reset is performed.

To successfully perform a firmware update, the following command sequence must be executed:

Stop program – clear program – download program with write access to →Program data

Related objects: →“Program data” on page 6-116

Name	Program control
Index	0x1F51
Object code	ARRAY
Highest subindex supported	1

### 6.2.36.1 Program number 1

Name	Program number 1
Index	0x1F51
Subindex	0x01
Data type	UNSIGNED8
Access type	RW
Default value	–
Value range	→Table 6-85
PDO mapping	NO
Backup	NO

Value	Write access	Read access
0x00	Stop program: Activate bootloader application	Program stopped: Bootloader application is active
0x01	Start program: Activate Program	Program started: Program is active
0x02	Reset program: Initiate device reset	Not used
0x03	Clear program: Erase the flash memory before new program data is downloaded	No program available: No valid application is available in the flash memory
0x04...0x07	reserved	reserved
0x80	Triggers an ESM state change acknowledge upon application restart. Relevant only for bootloader.	–

Table 6-85 Program control – Value range

## 6.2.37 Program software identification

Provides identification on the loaded program software.

If no valid flash content or program software is available, the program software identification is “0” (zero).

While the bootloader is active, the identification of the actually running bootloader version is returned. After a bootloader update, a device reset or start program command is required for display of the new identification number.

Name	Program software identification
Index	0x1F56
Object code	ARRAY
Highest subindex supported	1

### 6.2.37.1 Program number 1

Name	Program number 1
Index	0x1F56
Subindex	0x01
Data type	UNSIGNED32
Access type	RO
Default value	–
Value range	→ Table 6-86
PDO mapping	NO
Backup	NO

Bit	Description
31...16	Identification of the application
15...0	Identification of the bootloader

Table 6-86 Program software identification – Value range

## 6.2.38 Flash status identification

Displays the status of the firmware download process.

Name	Flash status identification
Index	0x1F57
Object code	ARRAY
Highest subindex supported	1

### 6.2.38.1 Program number 1

Name	Program number 1
Index	0x1F57
Subindex	0x01
Data type	UNSIGNED32
Access type	RO
Default value	–
Value range	→Table 6-87
PDO mapping	NO
Backup	NO

Continued on next page.

Bit	Value	Description	
31...16		Manufacturer-specific information	
15...8		Reserved, always 0	
7...1	127...93	Reserved for manufacturer-specific errors	
	92	Decryption error (a)	
	91	Authentication sequence error. Expected command sequence (activate bootloader – clear program – write program data) was not observed. (a)	
	90	Flash clear error (a)	
	89	Hardware version mismatch. Received firmware cannot be use with this hardware; manufacturer-specific error. (a)	
	88	Unspecified error (a)	
	87	Flash secured. Write access currently forbidden. (a)	
	86	General address error (a)	
	85	Flash write error (a)	
	84	Flash not cleared before write (a)	
	83	Data format error or data CRC error (a)	
	82	Data format unknown (a)	
	81	No valid program available (a)	
	80...68	Reserved for manufacturer-specific errors (a)	
	67	Decryption error	
	66	Authentication sequence error: Expected command sequence (activate bootloader – clear program – write program data) was not observed.	
	65	Flash clear error	
	64	Hardware version mismatch. Received firmware cannot be use with this hardware; manufacturer-specific error.	
	63	Unspecified error	
	62...8	Reserved	
	7	Flash secured. Write access currently forbidden.	
	6	General address error	
	5	Flash write error	
	4	Flash not cleared before write	
	3	Data format error or data CRC error	
	2	Data format unknown	
	1	No valid program available	
	0	No error occurred, valid program available	
	0	1	Download in progress. Program Software Identification is not valid.
		0	No download in progress. Program Software Identification is valid.

(a) Error received from extension communication module

Table 6-87 Flash status identification – Value range

### 6.2.39 Node-ID

Defines the node ID of the device and is used by the communication interfaces CAN and USB.

Changes to this object only come into effect after restart. Therefore, storing all parameters after a change is required, then restart.

Name	Node-ID	
Index	0x2000	
Subindex	0x00	
Data type	UNSIGNED8	
Access type	RW	
Default value	1	
Value range	1	127
PDO mapping	NO	
Backup	YES	

## 6.2.40 CAN bit rate

**THE OBJECT IS ONLY AVAILABLE FOR «IDX CANOPEN».**

Holds the desired bit rate of the CAN interface.

Changes to this object only come into effect after restart. Therefore, storing all parameters after a change is required, then restart.

Automatic bit rate detection is activated in the following cases:

- CAN bit rate is set to “9” and saved (followed by reset/power on).

Name	CAN bit rate
Index	0x2001
Subindex	0x00
Data type	UNSIGNED8
Access type	RW
Default value	0
Value range	→ Table 6-88
PDO mapping	NO
Backup	YES

Value	Bit rate
0	1 Mbit/s
1	800 kbit/s
2	500 kbit/s
3	250 kbit/s
4	125 kbit/s
(5)	reserved
6	50 kbit/s
7	20 kbit/s
(8)	not supported (10 kbit/s)
9	Automatic bite rate detection

Table 6-88 CAN bit rate

## 6.2.41 USB frame timeout

Defines the timeout over a USB communication frame. It is scaled in [ms].

Name	USB frame timeout	
Index	0x2006	
Subindex	0x00	
Data type	UNSIGNED16	
Access type	RW	
Default value	500	
Value range	50	65'535
PDO mapping	NO	
Backup	YES	

## 6.2.42 CAN bit rate display

**THE OBJECT IS ONLY AVAILABLE FOR «IDX CANOPEN».**

Represents the actually configured CAN bit rate. Its value can differ from the value of the object →“CAN bit rate” on page 6-122 if automatic bit rate detection is or was active. In all other cases, the value of these two objects are identical.

Related objects: →“CAN bit rate” on page 6-122

Name	CAN bit rate display
Index	0x200A
Subindex	0x00
Data type	UNSIGNED8
Access type	RO
Default value	–
Value range	→Table 6-88
PDO mapping	NO
Backup	NO

## 6.2.43 Active fieldbus

Shows the actual active fieldbus.

Name	Active fieldbus
Index	0x2010
Subindex	0x00
Data type	UNSIGNED8
Access type	RO
Default value	–
Value range	→Table 6-89
PDO mapping	NO
Backup	NO

Value	Fieldbus
0	None
1	CANopen
2	EtherCAT

Table 6-89 Fieldbus type

### 6.2.44 Active controller type

Shows the actual active controller type.

Name	Active controller type
Index	0x2011
Subindex	0x00
Data type	UNSIGNED8
Access type	RO
Default value	–
Value range	→ Table 6-90
PDO mapping	NO
Backup	NO

Value	Type
0	Servo controller
1	Positioning controller

Table 6-90 Active controller type

### 6.2.45 Additional identity

Name	Additional identity
Index	0x2100
Object code	ARRAY
Highest subindex supported	1

#### 6.2.45.1 Serial number complete

Contains the full 64-bit device serial number.

Name	Serial number complete
Index	0x2100
Subindex	0x01
Data type	UNSIGNED64
Access type	RO
Default value	–
Value range	–
PDO mapping	NO
Backup	YES



## 6.2.46 Extension 1 identity

**THE OBJECT IS ONLY AVAILABLE FOR «IDX ETHERCAT».**

Shows version information of the connected extension communication.

Name	Extension 1 identity
Index	0x2101
Object code	RECORD
Highest subindex supported	6

### 6.2.46.1 Extension 1 software version

Contains the software version of the connected extension communication.

Name	Extension 1 software version
Index	0x2101
Subindex	0x01
Data type	UNSIGNED16
Access type	RO
Default value	–
Value range	–
PDO mapping	NO
Backup	NO

### 6.2.46.2 Extension 1 hardware version

Contains the software version of the connected extension communication.

Name	Extension 1 hardware version
Index	0x2101
Subindex	0x02
Data type	UNSIGNED16
Access type	RO
Default value	–
Value range	→ Table 6-91
PDO mapping	NO
Backup	NO

Hardware version	Hardware
0x5100	EtherCAT extension

Table 6-91 Extension 1 hardware – Version definition

**6.2.46.3 Extension 1 application number**

Contains the application number of the connected extension communication.

Name	Extension 1 application number	
Index	0x2101	
Subindex	0x03	
Data type	UNSIGNED16	
Access type	RO	
Default value	–	
Value range	–	–
PDO mapping	NO	
Backup	NO	

**6.2.46.4 Extension 1 application version**

Contains the application number of the connected extension communication.

Name	Extension 1 application version	
Index	0x2101	
Subindex	0x04	
Data type	UNSIGNED16	
Access type	RO	
Default value	–	
Value range	–	–
PDO mapping	NO	
Backup	NO	

**6.2.46.5 Extension 1 serial number**

Contains the full 64-bit device serial number of the connected extension communication.

Name	Extension 1 serial number	
Index	0x2101	
Subindex	0x05	
Data type	UNSIGNED64	
Access type	RO	
Default value	–	
Value range	–	–
PDO mapping	NO	
Backup	NO	

**6.2.46.6 Extension 1 type**

Contains the type of the connected extension communication.

Name	Extension 1 type
Index	0x2101
Subindex	0x06
Data type	UNSIGNED8
Access type	RO
Default value	–
Value range	→ Table 6-92
PDO mapping	NO
Backup	NO

Value	Fieldbus
0	None
2	EtherCAT

Table 6-92 Extension communication type

**6.2.47 Custom persistent memory**

THE OBJECT IS ONLY AVAILABLE FOR «IDX CANOPEN» AND «IDX ETHERCAT».

Name	Custom persistent memory
Index	0x210C
Object code	ARRAY
Highest subindex supported	4

**6.2.47.1 Custom persistent memory (1...4)**

Can be used to store custom values (for example axis numbers, identifications, etc.) on the device. The stored values will not be evaluated by the firmware but will be cleared by setting the default parameters.

Names	Custom persistent memory 1 Custom persistent memory 2 Custom persistent memory 3 Custom persistent memory 4
Index	0x210C
Subindex	0x01...0x04
Data type	UNSIGNED32
Access type	RW
Default value	0
Value range	–
PDO mapping	NO
Backup	YES

## 6.2.48 *Power supply*

Used to display the power supply parameters.

Name	Power supply
Index	0x2200
Object code	RECORD
Highest subindex supported	1

### 6.2.48.1 *Power supply voltage*

Represents the actual power supply voltage. The value is given in [0.1 V].

Name	Power supply voltage
Index	0x2200
Subindex	0x01
Data type	UNSIGNED16
Access type	RO
Default value	–
Value range	–
PDO mapping	NO
Backup	NO

## 6.2.49 Axis configuration

Used to setup the main components of the axis by configuring the sensors and the control structure.

Write access is only permitted in device state «Power Disable».

Related objects: → “Motor type” on page 6-210

Name	Axis configuration
Index	0x3000
Object code	ARRAY
Highest subindex supported	6

### 6.2.49.1 Sensors configuration

Displays the sensor types used for the axis.

Related objects: → “SSI absolute encoder” on page 6-139

Name	Sensors configuration
Index	0x3000
Subindex	0x01
Data type	UNSIGNED32
Access type	RO
Default value	–
Value range	→ Table 6-93 and Table 6-94
PDO mapping	NO
Backup	NO

Bit 31...24	Bit 23...16	Bit 15...8	Bit 7...0
reserved (0)	Sensor 3 type	Sensor 2 type	Sensor 1 type

Table 6-93 Sensor configuration – Bits

Name	Value	Description
Sensor 1 type	0x00	None
Sensor 2 type	0x03	SSI absolute encoder
Sensor 3 type	0x00	None

Table 6-94 Supported sensor types

### 6.2.49.2 Control structure

Defines the control structure of the axis.

- Take into account that the position control quality depends, among other influences, on the resolution of the main sensor. For some sensor types, such as SSI, the “position refresh rate” has an additional influence on the position control quality. Increase the sensor’s “data rate” to improve position control quality.
- Upon changing this parameter, the absolute position may be corrupted. Therefore, →«Position referenced to home position» (→“Statusword” on page 6-181) and →“Position actual value” on page 6-185 will be cleared.

Name	Control structure
Index	0x3000
Subindex	0x02
Data type	UNSIGNED32
Access type	RW
Default value	Device-specific
Value range	→Table 6-95
PDO mapping	NO
Backup	YES

Bit	Name	Value	Description
31...28	reserved	0	–
27...26	Mounting Position Sensor 2	0	On motor (or undefined)
25...20	reserved	0	–
19...16	Main Sensor	2	Sensor 2
15...14	Process Value Reference	0	On motor (or undefined)
13	reserved	0	–
12	Gear	0	None
		1	Gear mounted to the system
11...8	Position Control Structure	0	None [a] [b]
		1	PID position controller [c]
7...4	Velocity Control Structure	1	PI velocity controller (low pass filter)
		2	PI velocity controller (observer)
3...0	Current Control Structure	1	PI current controller
[a] not available with «IDX CANopen» [b] not available with «IDX EtherCAT» [c] not available with «IDX I/O»			

Table 6-95 Control structure – Bits

### 6.2.49.3 Commutation sensors

Displays the commutation sensors for axis drive.

Name	Commutation sensors
Index	0x3000
Subindex	0x03
Data type	UNSIGNED32
Access type	RO
Default value	–
Value range	→ Table 6-96 and Table 6-97
PDO mapping	NO
Backup	NO

Bit	Name	Value	Description
31...8	reserved	0	–
7...4	Commutation Sensor Absolute	2	Sensor 2
3...0	Commutation Sensor Relative	0	None

Table 6-96 Commutation sensors – Bits

Value	Description	Motor type supported
0x00000020	Sensor 2 used for commutation	EC sinus (SSI encoder only)

Table 6-97 Commutation sensors – Value range

#### 6.2.49.4 *Axis configuration miscellaneous*

Used to define various options regarding the axis configuration.

Name	Axis configuration miscellaneous
Index	0x3000
Subindex	0x04
Data type	UNSIGNED32
Access type	RW
Default value	0x00000000
Value range	→Table 6-98
PDO mapping	NO
Backup	YES

Bit	Name	Value	Description
31...9	reserved	0	–
8	Sensor supervision	1	Main sensor supervision disabled
		0	Main sensor supervision enabled
7...1	reserved	0	–
0	Axis polarity	1	Inverse polarity – rotational direction of the axis is CW when positive demanded values are attached
		0	Normal polarity – rotational direction of the axis is CCW when positive demanded values are attached

Table 6-98 Axis configuration miscellaneous – Bits

#### 6.2.49.5 *Main sensor resolution*

Displays the resolution of the main sensor given in [increments/revolution].

Name	Main sensor resolution
Index	0x3000
Subindex	0x05
Data type	UNSIGNED32
Access type	RO
Default value	–
Value range	–
PDO mapping	NO
Backup	NO



## 6.2.49.6 Max system speed

Displays the max system speed. The value is given in [velocity units] (→page 2-17).

Related objects: →“Motor type” on page 6-210 / →“Max profile velocity” on page 6-191 / →“Max motor speed” on page 6-192 / →“Target velocity” on page 6-210 / →“Max gear input speed” on page 6-138

Name	Max system speed	
Index	0x3000	
Subindex	0x06	
Data type	UNSIGNED32	
Access type	RO	
Default value	–	
Value range	1	→ Table 6-99 → Table 6-100
PDO mapping	NO	
Backup	NO	

Velocity limit		Max motor speed greater Max gear input speed	Max motor speed lower or equal Max gear input speed
Gear	no	Max motor speed	Max motor speed
	yes	$\frac{\text{Max gear input speed}}{\text{Absolute gear reduction}}$	$\frac{\text{Max motor speed}}{\text{Absolute gear reduction}}$

Table 6-99 Max system speed – Limits

Velocity units factor	Max system speed limited by velocity units	Limit
$10^0 / 10^{-1} / 10^{-2} / 10^{-3} / 10^{-4}$	No	—
$10^{-5}$	Yes	21474.83647
$10^{-6}$	Yes	2147.483647

Table 6-100 Max system speed – Speed limitations based on velocity units

## 6.2.50 Motor data

Used to configure the parameters of the motor.

Related objects: →“Motor type” on page 6-210

Name	Motor data
Index	0x3001
Object code	RECORD
Highest subindex supported	5

### 6.2.50.1 Nominal current

Represents the nominal current of the motor [mA]. Continuous operation of the motor at this current level and at 25 °C ambient will cause the winding to ultimately reach the specified maximal winding temperature. This assumes no heat sinking.

Related objects: →“Motor rated torque” on page 6-187

Name	Nominal current
Index	0x3001
Subindex	0x01
Data type	UNSIGNED32
Access type	RW
Default value	Device-specific
Value range	Device-specific
PDO mapping	RXPDO
Backup	YES

### 6.2.50.2 Output current limit

Represents the maximal permissible current of the motor [mA]. We recommend to set the value to double of →Nominal current. The value can be substantially increased if the motor mount is made of heat-dissipating materials.

Related objects: →“Thermal time constant winding” on page 6-135

Name	Output current limit
Index	0x3001
Subindex	0x02
Data type	UNSIGNED32
Access type	RW
Default value	Device-specific
Value range	Device-specific
PDO mapping	RXPDO
Backup	YES

**6.2.50.3** *Number of pole pairs*

Represents the number of magnetic pole pairs (number of poles divided by 2) of the rotor of a brushless DC motor (maxon EC motor/BLDC motor).

Related objects: → "Max motor speed" on page 6-192

Name	Number of pole pairs	
Index	0x3001	
Subindex	0x03	
Data type	UNSIGNED8	
Access type	RO	
Default value	–	
Value range	–	–
PDO mapping	NO	
Backup	NO	

**6.2.50.4** *Thermal time constant winding*

Represents the thermal time constant of motor winding. The value is given in [0.1 s]. Example: For a time constant of 4 seconds, set the value "40".

Name	Thermal time constant winding	
Index	0x3001	
Subindex	0x04	
Data type	UNSIGNED16	
Access type	RO	
Default value	–	
Value range	–	–
PDO mapping	NO	
Backup	NO	

**6.2.50.5** *Torque constant*

Represents the motor's torque constant. The value is given in [ $\mu\text{Nm/A}$ ].

Related objects: → "Motor rated torque" on page 6-187

Name	Torque constant	
Index	0x3001	
Subindex	0x05	
Data type	UNSIGNED32	
Access type	RO	
Default value	–	
Value range	–	–
PDO mapping	NO	
Backup	NO	

## 6.2.51 *Electrical system parameters*

The parameters are evaluated during the auto tuning identification of the electrical system. They are used during the auto tuning identification of the mechanical system to calculate the torque constant.

Name	Electrical system parameters
Index	0x3002
Object code	RECORD
Highest subindex supported	2

### 6.2.51.1 *Electrical resistance*

Represents the electrical system resistance. The value is given in [mΩ].

Name	Electrical resistance
Index	0x3002
Subindex	0x01
Data type	UNSIGNED32
Access type	RO
Default value	–
Value range	–
PDO mapping	NO
Backup	NO

### 6.2.51.2 *Electrical inductance*

Represents the electrical system inductance. The value is given in [μH].

Name	Electrical inductance
Index	0x3002
Subindex	0x02
Data type	UNSIGNED16
Access type	RO
Default value	–
Value range	–
PDO mapping	NO
Backup	NO

## 6.2.52 Gear configuration

Used to setup configuration of a gear. A gear can only be used if the corresponding value of →Axis configuration (→Control structure) has been configured (not “none”).

Write access is only permitted in device state «Power Disable».

Related objects: →“Axis configuration” on page 6-129

Name	Gear configuration
Index	0x3003
Object code	ARRAY
Highest subindex supported	4

### 6.2.52.1 Gear reduction numerator

The absolute gear reduction is calculated by division of gear reduction numerator by gear reduction denominator. It is also the ratio of input speed/turns as well as output speed/turns of a gear.

For detailed gear specifications →maxon catalog.

Name	Gear reduction numerator	
Index	0x3003	
Subindex	0x01	
Data type	UNSIGNED32	
Access type	RW	
Default value	Device-specific	
Value range	1	4'294'967'295
PDO mapping	NO	
Backup	YES	

### 6.2.52.2 Gear reduction denominator

The absolute gear reduction is calculated by division of gear reduction numerator by gear reduction denominator. It is also the ratio of input speed/turns as well as output speed/turns of a gear.

For detailed gear specifications →maxon catalog.

Name	Gear reduction denominator	
Index	0x3003	
Subindex	0x02	
Data type	UNSIGNED32	
Access type	RW	
Default value	Device-specific	
Value range	1	4'294'967'295
PDO mapping	NO	
Backup	YES	

### 6.2.52.3 Max gear input speed

Indicates the configured maximal allowed input speed for the gear. It serves as protection of the gear. Together with the →Max motor speed, it limits the gear's output speed. The value is given in [rpm].

For detailed gear specifications →maxon catalog.

Write access is permitted in device state «Power Enabled».

Related objects: →“Max profile velocity” on page 6-191 / →“Axis configuration” on page 6-129

Name	Max gear input speed		
Index	0x3003		
Subindex	0x03		
Data type	UNSIGNED32		
Access type	RW		
Default value	Device-specific		
Value range	1	Device-specific	
PDO mapping	NO		
Backup	YES		

Velocity limit		Max motor speed greater Max gear input speed	Max motor speed lower or equal Max gear input speed
Gear	no	Max motor speed	Max motor speed
	yes	$\frac{\text{Max gear input speed}}{\text{Absolute gear reduction}}$	$\frac{\text{Max motor speed}}{\text{Absolute gear reduction}}$

Table 6-101 Gear velocity limits

### 6.2.52.4 Gear miscellaneous configuration

Used to define various options regarding the gear configuration.

Name	Gear miscellaneous configuration		
Index	0x3003		
Subindex	0x04		
Data type	UNSIGNED32		
Access type	RW		
Default value	Device-specific		
Value range	→Table 6-102		
PDO mapping	NO		
Backup	YES		

Bit	Name	Value	Description
31...1	reserved	0	–
0	Gear direction	0	Normal (rotational direction of input and output are the same)
		1	Inverted (rotational direction of input and output are opposite)

Table 6-102 Gear miscellaneous configuration – Bits

### 6.2.53 SSI absolute encoder

Represents the configuration of the SSI absolute encoder. Make sure to activate the SSI absolute encoder for the respective axis using →“Axis configuration” on page 6-129.

Write access is only permitted if the corresponding axis is in state «Power Disable».

Name	SSI absolute encoder
Index	0x3012
Object code	RECORD
Highest subindex supported	13

#### 6.2.53.1 SSI data rate

Represents the SSI encoder data rate (SSI clock frequency). The value is given in [kbit/s].

The maximal data rate depends on the actual cable length and the configuration of the encoder. For the correlation between cable length and data rate →Figure 6-31. Use cables with twisted pairs.

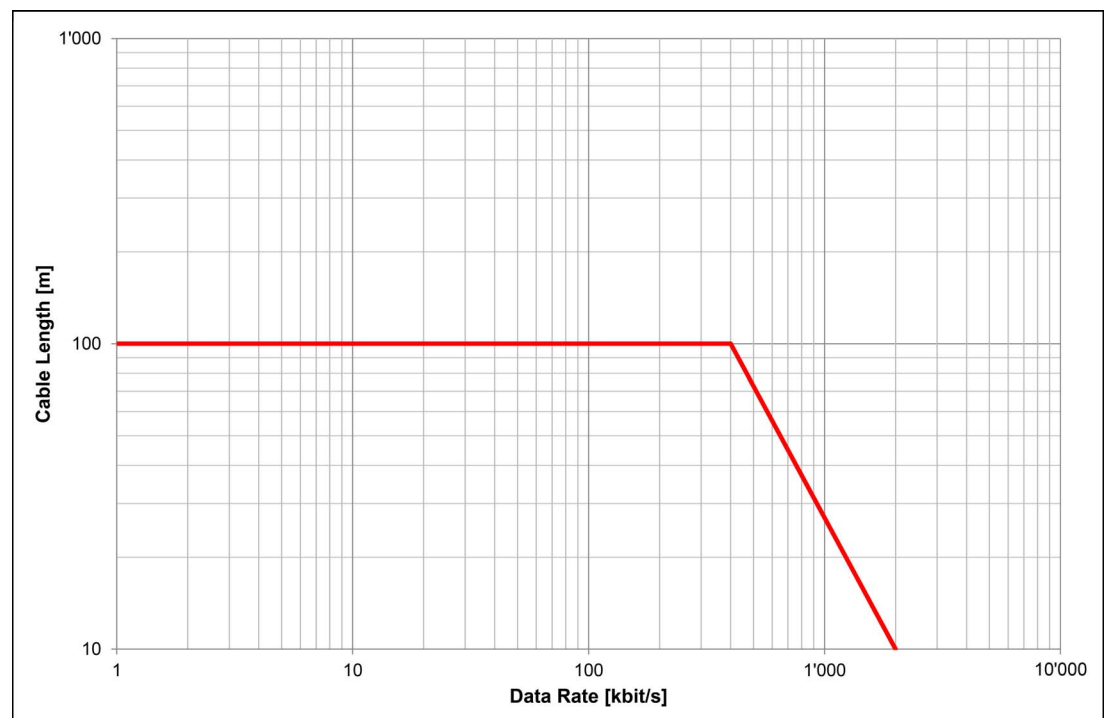

Figure 6-31 SSI encoder – Data rate vs. cable length

Name	SSI data rate
Index	0x3012
Subindex	0x01
Data type	UNSIGNED16
Access type	RO
Default value	–
Value range	–
PDO mapping	NO
Backup	NO

**6.2.53.2 SSI number of data bits**

Represents the number of multi-turn, single-turn, and special bits of the SSI data frame. The maximum value combined is 62 (including special bits → Figure 6-32).

Related objects: → “SSI position bits” on page 6-145

Name	SSI number of data bits
Index	0x3012
Subindex	0x02
Data type	UNSIGNED32
Access type	RO
Default value	–
Value range	→ Table 6-103
PDO mapping	NO
Backup	NO

Bit	Name	Default	Min	Max
31...24	reserved	0	0	16
23...16	Multi-turn bits	0	0	32
15...8	Single-turn bits	12	6	32
7...0	Special bits	0	0	16

Table 6-103 SSI encoder – Number of data bits

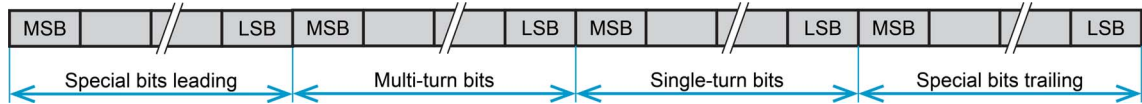

Figure 6-32 SSI encoder – Data frame



**6.2.53.3 SSI encoding type**

Represents the type of SSI encoding.

Name	SSI encoding type
Index	0x3012
Subindex	0x03
Data type	UNSIGNED16
Access type	RO
Default value	–
Value range	→Table 6-104
PDO mapping	NO
Backup	NO

Bit	Name	Value	Description	Default
15...10	reserved	0	—	0
9	Reference reset	0	No reference reset on frame error	0
		1	Reset referenced flag on frame error (→Statusword)	
8	Check frame	0	No frame checking	0
		1	Frame start and end bit checking	
7...5	reserved	0	—	0
4	Direction	0	maxon	0
		1	Inverted (or encoder mounted on motor shaft)	
3...0	Encoding type	0	Binary coded data	0
		1	Gray coded data	
		–	reserved	

Table 6-104 SSI encoder – Protocol

**6.2.53.4 SSI timeout time**

Represents the minimal duration after the last clock edge of a sequence until the first clock edge of the next sequence (→ Figure 6-33). The value is given in [μs].

Name	SSI timeout time	
Index	0x3012	
Subindex	0x05	
Data type	UNSIGNED16	
Access type	RO	
Default value	-	
Value range	-	-
PDO mapping	NO	
Backup	NO	

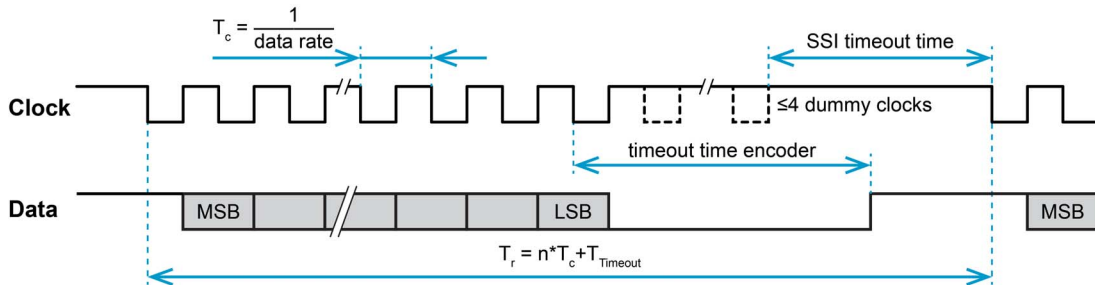

Figure 6-33 SSI encoder – Timing

**6.2.53.5 SSI special bits trailing data**

The trailing special bits of the SSI data frame will be copied to this object if the number of special bits trailing >0 (→ Table 6-103). In the device, no additional processing of the special bits will take place, thus, subsequent processing must be handled by the superior application.

Name	SSI special bits trailing data	
Index	0x3012	
Subindex	0x06	
Data type	UNSIGNED16	
Access type	RO	
Default value	-	
Value range	-	-
PDO mapping	YES	
Backup	NO	

**6.2.53.6 SSI refresh frequency**

Displays the momentarily used refresh frequency. The maximal refresh frequency is  $1/T_r$ . However, this can be smaller depending on the device's internal timings conditions (→ Figure 6-33). The value is given in [Hz]; typically are 25'000, 12'5000, 5'000.

Related objects: → "SSI absolute encoder" on page 6-139

Name	SSI refresh frequency	
Index	0x3012	
Subindex	0x07	
Data type	UNSIGNED32	
Access type	RO	
Default value	–	
Value range	–	–
PDO mapping	NO	
Backup	NO	

**6.2.53.7 SSI power up time**

Represents the duration from power-up until the SSI encoder is initialized and ready for operation. The value is given in [ms].

Name	SSI power up time	
Index	0x3012	
Subindex	0x08	
Data type	UNSIGNED16	
Access type	RO	
Default value	–	
Value range	–	–
PDO mapping	NO	
Backup	NO	

**6.2.53.8 SSI position raw value**

Represents the lower 32 bit part of the actual SSI absolute position raw value derived directly by the encoder (right aligned).

Name	SSI position raw value	
Index	0x3012	
Subindex	0x09	
Data type	UNSIGNED32	
Access type	RO	
Default value	–	
Value range	–	–
PDO mapping	NO	
Backup	NO	

**6.2.53.9 SSI commutation offset value**

Represents the SSI absolute position offset value to align to the “0” (zero) angle position for commutation purposes. The SSI commutation offset [0...encoder resolution] represents [0°...360°].

For detailed information → separate document «IDX Application Notes»; section “Adjustment of SSI Commutation Offset Value” (find a list of sources → chapter “1.1.6 Sources for additional Information” on page 1-10).

Name	SSI commutation offset value	
Index	0x3012	
Subindex	0x0A	
Data type	UNSIGNED32	
Access type	RO	
Default value	–	
Value range	–	–
PDO mapping	NO	
Backup	NO	



**Encoder alignment**

- If you are using a maxon absolute encoder, the alignment is factory-set and the “SSI commutation offset value” does not require to be set.
- If you are using a third party absolute encoder, you must...
  - either ensure that the alignment follows the specified pattern (→ Figure 6-34)
  - or use the “SSI commutation offset value” to align the angle position.

**Signal Sequence of Hall Sensors**

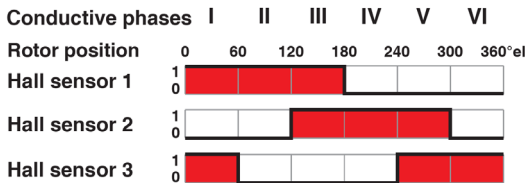

**Supplied Motor Voltage (Phase to Phase)**

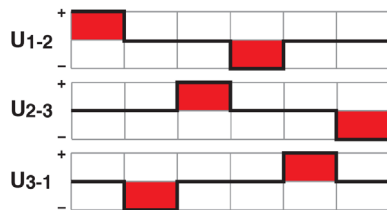

Figure 6-34 Block commutation of EC (BLDC) motors – Definition of phases

### 6.2.53.10 SSI position bits

Unlike the SSI encoder's maximal data length of 62 bit (→“SSI number of data bits” on page 6-140), the position format of the device has a maximum length of 32 bits. Hence, the number of data bits used by the SSI encoder must be reduced, if the sum exceeds 32 multi-turn/single-turn bits.

Among other instances, the number of single-turn bits is also used for calculation of the actual speed. The resolution for rotary encoders is as follows:

$$Resolution = 2^{\text{Single-turn bits}} \left[ \frac{inc}{rev} \right]$$

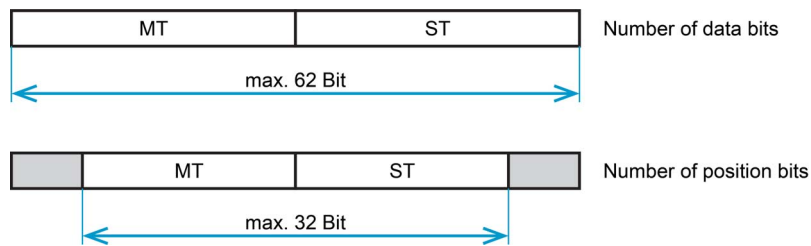

Figure 6-35 SSI encoder – Data bits

Name	SSI position bits
Index	0x3012
Subindex	0x0B
Data type	UNSIGNED32
Access type	RO
Default value	–
Value range	→Table 6-105
PDO mapping	NO
Backup	NO

Bit	Name	Default	Min	Max
31...16	reserved	0	–	–
15...8	Multi-turn bits	0	0	26
7...0	Single-turn bits	12	6	31

Table 6-105 SSI position bits

#### 6.2.53.11 SSI special bits leading data

The leading special bits of the SSI data frame will be copied to this object if the number of special bits leading >0 (→Table 6-103). In the device, no additional processing of special bits will take place, thus, subsequent processing must be handled by the superior application.

Name	SSI special bits leading data	
Index	0x3012	
Subindex	0x0C	
Data type	UNSIGNED16	
Access type	RO	
Default value	–	
Value range	–	–
PDO mapping	YES	
Backup	NO	

#### 6.2.53.12 SSI position raw value complete

Represents the actual SSI absolute position raw value [MT, ST] derived directly by the encoder.

Name	SSI position raw value complete	
Index	0x3012	
Subindex	0x0D	
Data type	UNSIGNED64	
Access type	RO	
Default value	–	
Value range	–	–
PDO mapping	NO	
Backup	NO	

## 6.2.54 Current control parameter set

Holds the current controller parameters. The current controller is realized with a digital PI controller.

Name	Current control parameter set
Index	0x30A0
Object code	ARRAY
Highest subindex supported	2

### 6.2.54.1 Current controller P gain

Represents the proportional gain of the current controller. The value is given in  $[\frac{\mu V}{A}]$ .

Name	Current controller P gain
Index	0x30A0
Subindex	0x01
Data type	UNSIGNED32
Access type	RW
Default value	Device-specific
Value range	–
PDO mapping	RXPDO
Backup	YES

### 6.2.54.2 Current controller I gain

Represents the integral gain of the current controller. The value is given in  $[\frac{\mu V}{A \cdot ms}]$ .

Name	Current controller I gain
Index	0x30A0
Subindex	0x02
Data type	UNSIGNED32
Access type	RW
Default value	Device-specific
Value range	–
PDO mapping	RXPDO
Backup	YES

## 6.2.55 Position control parameter set

**THE OBJECT IS ONLY AVAILABLE FOR «IDX CANOPEN» AND «IDX ETHERCAT».**

Holds the position controller parameters. The position controller is realized with a digital PID controller.

Name	Position control parameter set
Index	0x30A1
Object code	ARRAY
Highest subindex supported	5

### 6.2.55.1 Position controller P gain

Represents the proportional gain of the position controller. The value is given in  $[\frac{\mu A}{rad}]$ .

Name	Position controller P gain
Index	0x30A1
Subindex	0x01
Data type	UNSIGNED32
Access type	RW
Default value	3'600'000
Value range	–
PDO mapping	RXPDO
Backup	YES

### 6.2.55.2 Position controller I gain

Represents the integral gain of the position controller. The value is given in  $[\frac{\mu A}{rad \cdot s}]$ .

Name	Position controller I gain
Index	0x30A1
Subindex	0x02
Data type	UNSIGNED32
Access type	RW
Default value	50'000'000
Value range	–
PDO mapping	RXPDO
Backup	YES



**6.2.55.3 Position controller D gain**

Represents the differential gain of the position controller. The value is given in  $[\frac{\mu A \cdot s}{rad}]$ .

Name	Position controller D gain	
Index	0x30A1	
Subindex	0x03	
Data type	UNSIGNED32	
Access type	RW	
Default value	50'000	
Value range	–	–
PDO mapping	RXPDO	
Backup	YES	

**6.2.55.4 Position controller FF velocity gain**

Represents the speed feedforward gain of the position controller. The value is given in  $[\frac{\mu A \cdot s}{rad}]$ .

Name	Position controller FF velocity gain	
Index	0x30A1	
Subindex	0x04	
Data type	UNSIGNED32	
Access type	RW	
Default value	2'000	
Value range	–	–
PDO mapping	RXPDO	
Backup	YES	

**6.2.55.5 Position controller FF acceleration gain**

Represents the acceleration feedforward gain of the position controller. The value is given in  $[\frac{\mu A \cdot s^2}{rad}]$ .

Name	Position controller FF acceleration gain	
Index	0x30A1	
Subindex	0x05	
Data type	UNSIGNED32	
Access type	RW	
Default value	500	
Value range	–	–
PDO mapping	RXPDO	
Backup	YES	

## 6.2.56 Velocity control parameter set

Velocity regulation is implemented with a digital PI controller. The object holds all parameters of the velocity controller.

Name	Velocity control parameter set
Index	0x30A2
Object code	ARRAY
Highest subindex supported	4

### 6.2.56.1 Velocity controller P gain

Represents the proportional gain of the velocity controller. The value is given in  $[\frac{\mu A \cdot s}{rad}]$ .

Name	Velocity controller P gain
Index	0x30A2
Subindex	0x01
Data type	UNSIGNED32
Access type	RW
Default value	60'000
Value range	–
PDO mapping	RXPDO
Backup	YES

### 6.2.56.2 Velocity controller I gain

Represents the integral gain of the velocity controller. The value is given in  $[\frac{\mu A}{rad}]$ .

Name	Velocity controller I gain
Index	0x30A2
Subindex	0x02
Data type	UNSIGNED32
Access type	RW
Default value	1'200'000
Value range	–
PDO mapping	RXPDO
Backup	YES

**6.2.56.3 Velocity controller FF velocity gain**

Represents the speed feedforward gain of the velocity controller. The value is given in  $[\frac{\mu A \cdot s}{rad}]$ .

Name	Velocity controller FF velocity gain	
Index	0x30A2	
Subindex	0x03	
Data type	UNSIGNED32	
Access type	RW	
Default value	2'000	
Value range	–	–
PDO mapping	RXPDO	
Backup	YES	

**6.2.56.4 Velocity controller FF acceleration gain**

Represents the acceleration feedforward gain of the velocity controller. The value is given in  $[\frac{\mu A \cdot s^2}{rad}]$ .

Name	Velocity controller FF acceleration gain	
Index	0x30A2	
Subindex	0x04	
Data type	UNSIGNED32	
Access type	RW	
Default value	500	
Value range	–	–
PDO mapping	RXPDO	
Backup	YES	

## 6.2.57 Velocity observer parameter set

Velocity observation is implemented with a digital disturbance observer. The object holds all parameters of the velocity observer.

Name	Velocity observer parameter set
Index	0x30A3
Object code	ARRAY
Highest subindex supported	5

### 6.2.57.1 Velocity observer position correction gain

Represents the position correction gain of the velocity observer. The value is given in [%].

Name	Velocity observer position correction gain
Index	0x30A3
Subindex	0x01
Data type	UNSIGNED32
Access type	RW
Default value	868
Value range	–
PDO mapping	RXPDO
Backup	YES

### 6.2.57.2 Velocity observer velocity correction gain

Represents the velocity correction gain of the velocity observer. The value is given in [mHz].

Name	Velocity observer velocity correction gain
Index	0x30A3
Subindex	0x02
Data type	UNSIGNED32
Access type	RW
Default value	500'000
Value range	–
PDO mapping	RXPDO
Backup	YES

**6.2.57.3 Velocity observer load correction gain**

Represents the load correction gain of the velocity observer. The value is given in  $[\frac{\mu Nm}{rad}]$ .

Name	Velocity observer load correction gain	
Index	0x30A3	
Subindex	0x03	
Data type	UNSIGNED32	
Access type	RW	
Default value	200'000	
Value range	–	–
PDO mapping	RXPDO	
Backup	YES	

**6.2.57.4 Velocity observer friction**

Represents the velocity observer friction. The value is given in  $[0.001 \cdot \frac{\mu Nm}{rpm}]$ .

Name	Velocity observer friction	
Index	0x30A3	
Subindex	0x04	
Data type	UNSIGNED32	
Access type	RW	
Default value	3'000	
Value range	–	–
PDO mapping	RXPDO	
Backup	YES	

**6.2.57.5 Velocity observer inertia**

Represents the velocity observer inertia. The value is given in  $[0.001 g \cdot cm^2]$ .

Name	Velocity observer inertia	
Index	0x30A3	
Subindex	0x05	
Data type	UNSIGNED32	
Access type	RW	
Default value	300'000	
Value range	–	–
PDO mapping	RXPDO	
Backup	YES	

### 6.2.58 Home position

**THE OBJECT IS ONLY AVAILABLE FOR «IDX CANOPEN» AND «IDX ETHERCAT».**

Defines the position that will be set as zero position of the absolute position counter. The value is given in [position units] (→page 2-17).

Related objects: →“Home offset move distance” on page 6-154

Name	Home position	
Index	0x30B0	
Subindex	0x00	
Data type	INTEGER32	
Access type	RW	
Default value	0	
Value range	–	–
PDO mapping	RXPDO	
Backup	YES	

### 6.2.59 Home offset move distance

**THE OBJECT IS ONLY AVAILABLE FOR «IDX CANOPEN» AND «IDX ETHERCAT».**

Represents a moving distance in a homing procedure. It is useful to move away from a detected position (for example mechanical limit stop or limit switch) at the end of the homing sequence, thus preventing the axis from a border damage respectively limit switch error.

Name	Home offset move distance	
Index	0x30B1	
Subindex	0x00	
Data type	INTEGER32	
Access type	RW	
Default value	0	
Value range	–	–
PDO mapping	NO	
Backup	YES	

### 6.2.60 Current threshold for homing mode

**THE OBJECT IS ONLY AVAILABLE FOR «IDX CANOPEN» AND «IDX ETHERCAT».**

Used for homing modes «-1», «-2», «-3», and «-4». A mechanical border will be detected when the measured motor current rises above the specified threshold [mA].

Name	Current threshold for homing mode	
Index	0x30B2	
Subindex	0x00	
Data type	UNSIGNED16	
Access type	RW	
Default value	500	
Value range	–	Maximal value of → Output current limit
PDO mapping	RXPDO	
Backup	YES	

### 6.2.61 Current demand value

The set value for the current controller. The value is given in [mA].

Name	Current demand value	
Index	0x30D0	
Subindex	0x00	
Data type	INTEGER32	
Access type	RO	
Default value	–	
Value range	–	–
PDO mapping	TXPDO	
Backup	NO	

## 6.2.62 *Current actual values*

Provides the actual current values.

Name	Current actual values
Index	0x30D1
Object code	ARRAY
Highest subindex supported	2

### 6.2.62.1 *Current actual value averaged*

Represents the →“Current actual value” on page 6-156 filtered by 1<sup>st</sup> order digital low-pass filter with a cut-off frequency of 50 Hz. The value is given in [mA].

Name	Current actual value averaged
Index	0x30D1
Subindex	0x01
Data type	INTEGER32
Access type	RO
Default value	–
Value range	–
PDO mapping	TXPDO
Backup	NO

### 6.2.62.2 *Current actual value*

Provides the actual value of the motor's current. The value is given in [mA].

Name	Current actual value
Index	0x30D1
Subindex	0x02
Data type	INTEGER32
Access type	RO
Default value	–
Value range	–
PDO mapping	TXPDO
Backup	NO



### 6.2.63 Torque actual values

Provides the actual torque values.

Name	Torque actual values
Index	0x30D2
Object code	ARRAY
Highest subindex supported	1

#### 6.2.63.1 Torque actual value averaged

Represents the →“Torque actual value” on page 6-187 filtered by 1<sup>st</sup> order digital low-pass filter with a cut-off frequency of 50 Hz. The value is given in  $[\frac{MotorRatedTorque}{1000}]$ .

Related objects: →“Torque actual value” on page 6-187

Name	Torque actual value averaged	
Index	0x30D2	
Subindex	0x01	
Data type	INTEGER16	
Access type	RO	
Default value	–	
Value range	–	–
PDO mapping	TXPDO	
Backup	NO	

## 6.2.64 Velocity actual values

Provides the actual velocity values.

Name	Velocity actual values
Index	0x30D3
Object code	ARRAY
Highest subindex supported	1

### 6.2.64.1 Velocity actual value averaged

Represents the →“Velocity actual value” on page 6-186 filtered by 1<sup>st</sup> order digital low-pass filter with a cut-off frequency of 5 Hz.

Provides the actual averaged velocity value of the axis, derived by the main sensor defined in →“Axis configuration” on page 6-129. If no main sensor is configured, the velocity actual value is “0” (zero). The value is given in [velocity units] (→page 2-17).

Related objects: →“Velocity actual value” on page 6-186

Name	Velocity actual value averaged
Index	0x30D3
Subindex	0x01
Data type	INTEGER32
Access type	RO
Default value	–
Value range	–
PDO mapping	TXPDO
Backup	NO

## 6.2.65 Standstill window configuration

Configures the conditions to detect when the drive has come to a standstill. The functionality specifies the behavior of some device state machine transitions (→“Device Control” on page 2-14).

The following transitions are not performed until standstill condition is reached:

- «Operation Enable» → «Switch on disabled»
- «Operation Enable» → «Ready to switch on»
- «Operation Enable» → «Switched on»
- «Fault reaction active» → «Fault»

The slowdown behavior can be configured using the related objects.

Related objects: →“Abort connection option code” on page 6-179 / →“Shutdown option code” on page 6-182 / →“Disable operation option code” on page 6-183 / →“Fault reaction option code” on page 6-183

Name	Standstill window configuration
Index	0x30E0
Object code	RECORD
Highest subindex supported	3

### 6.2.65.1 Standstill window

Defines a symmetric range of accepted velocity values relatively to zero.

Standstill is reached, if the →“Velocity actual value averaged” on page 6-158 is within the standstill window (0x01) for the duration of the standstill window time (0x02). The value is given in [velocity units] (→page 2-17).

The value “4'294'967'295” ( $2^{32}-1$ ) switches off standstill detection and standstill is deemed to be reached at the end of the trajectory.

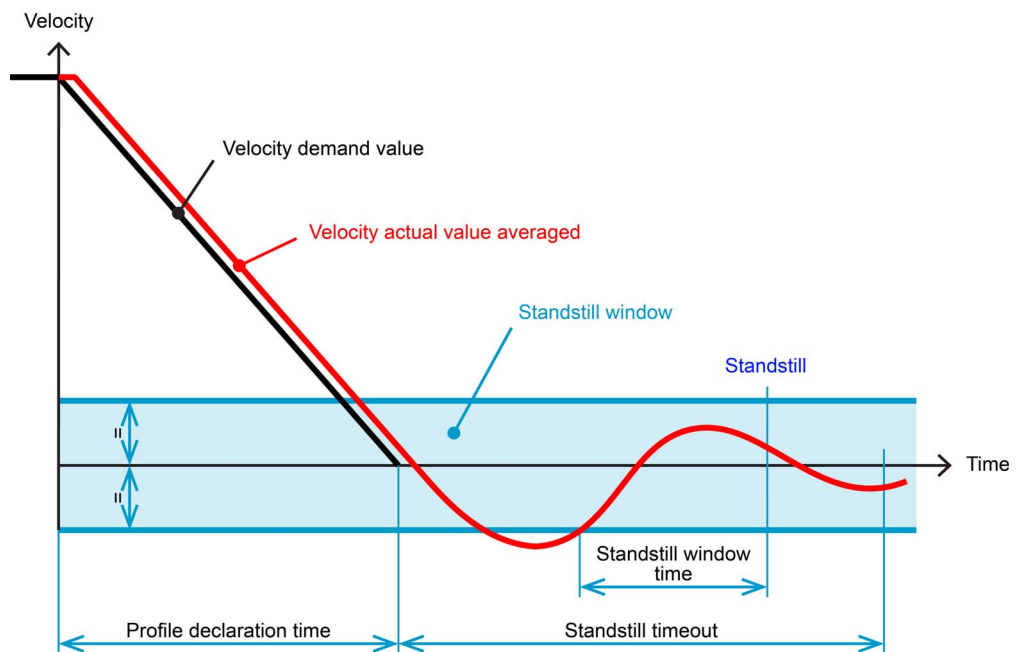

Figure 6-36 Standstill window

Continued on next page.

Name	Standstill window	
Index	0x30E0	
Subindex	0x01	
Data type	UNSIGNED32	
Access type	RW	
Default value	30	
Value range	–	–
PDO mapping	NO	
Backup	YES	

### 6.2.65.2 Standstill window time

Standstill is reached, if the →“Velocity actual value averaged” on page 6-158 is within the standstill window (0x01) for the duration of the standstill window time (0x02). The value is given in [ms].

Name	Standstill window time	
Index	0x30E0	
Subindex	0x02	
Data type	UNSIGNED16	
Access type	RW	
Default value	2	
Value range	–	–
PDO mapping	NO	
Backup	YES	

### 6.2.65.3 Standstill window timeout

Defines the point of time standstill is supposed to be reached, even if the standstill conditions are not yet fulfilled. This timeout may be used to prevent “hangs” in the device state machine in case the standstill window configuration or the velocity controller parameters are set inauspicious. The value is given in [ms].

The value “65'535” will disable the timeout.

Name	Standstill window timeout	
Index	0x30E0	
Subindex	0x03	
Data type	UNSIGNED16	
Access type	RW	
Default value	1000	
Value range	–	–
PDO mapping	NO	
Backup	YES	

## 6.2.66 Digital input properties

Related objects: →“Configuration of digital inputs” on page 6-162 / →“Digital inputs” on page 6-208

Name	Digital input properties
Index	0x3141
Object code	ARRAY
Highest subindex supported	2

### 6.2.66.1 Digital inputs logic state

Displays the state of the digital input logic signal (before polarity correction). A bit is read as “1” if the signal at the corresponding pin is high.

Name	Digital inputs logic state
Index	0x3141
Subindex	0x01
Data type	UNSIGNED16
Access type	RO
Default value	–
Value range	–
PDO mapping	TXPDO
Backup	NO

Bit	Default value
3	Digital input 4
2	Digital input 3
1	Digital input 2
0	Digital input 1

Table 6-106 Digital input bits

### 6.2.66.2 Digital inputs polarity

Used to set the polarity of the digital input functionalities. If a bit is set to “0” (zero), the associated pin is high active. For bit description →Table 6-106.

Name	Digital inputs polarity
Index	0x3141
Subindex	0x02
Data type	UNSIGNED16
Access type	RW
Default value	0x0000
Value range	–
PDO mapping	NO
Backup	YES

## 6.2.67 Configuration of digital inputs

Configures the functionality that will be assigned to digital inputs.

Related objects: →“Digital input properties” on page 6-161 / →“Digital inputs” on page 6-208

Name	Configuration of digital inputs
Index	0x3142
Object code	ARRAY
Highest subindex supported	4

### 6.2.67.1 Digital input configuration

Maps functions to digital inputs. Each function can only be mapped once, each digital input can only hold one function.

Names	Digital input 1 configuration Digital input 2 configuration Digital input 3 configuration Digital input 4 configuration
Index	0x3142
Subindex	0x01...0x04
Data type	UNSIGNED8
Access type	RW
Default value	→Table 6-107
Value range	→Table 6-107
PDO mapping	NO
Backup	YES

Digital input	Default value	
	«IDX CANopen» «IDX EtherCAT»	«IDX I/O»
DgIn1	0: Negative limit switch	16: General purpose A
DgIn2	1: Positive limit switch	17: General purpose B
DgIn3	2: Home switch	18: General purpose C
DgIn4	19: General purpose D	19: General purpose D

Table 6-107 Digital inputs – Default values

Continued on next page.

Value	Functionality	Description
255	None	No functionality assigned
254...29	reserved	–
28	Quick stop	Stop movement and switch to «Quick stop active» state (→“Device Control” on page 2-14 for valid transitions)
27	Drive enable	Enable/disable the drive or clear errors in «Fault» state (→“Device Control” on page 2-14 for valid transitions)
26	Touch probe [a]	Samples actual position
25	Positive limit switch without errors [a]	Used in some homing modes / does not generate limit errors
24	Negative limit switch without errors [a]	Used in some homing modes / does not generate limit errors
23...20	reserved	–
19	General purpose D	State can be read
18	General purpose C	State can be read
17	General purpose B	State can be read
16	General purpose A	State can be read
15...3	reserved	–
2	Home switch [a]	Used in some homing modes
1	Positive limit switch [a]	Used in some homing modes / generates limit error
0	Negative limit switch [a]	Used in some homing modes / generates limit error
[a] not available with «IDX I/O»		

Table 6-108 Digital inputs – Configuration

## 6.2.68 Digital output properties

Related objects: →“Configuration of digital outputs” on page 6-165 / →“Digital outputs” on page 6-209

Name	Digital output properties
Index	0x3150
Object code	ARRAY
Highest subindex supported	2

### 6.2.68.1 Digital outputs logic state

Displays the digital output logic state (after polarity correction). A bit is read as “1” if the signal at the corresponding pin is high.

Name	Digital outputs logic state
Index	0x3150
Subindex	0x01
Data type	UNSIGNED16
Access type	RO
Default value	–
Value range	–
PDO mapping	TXPDO
Backup	NO

Bit	Description
1	Digital output 2
0	Digital output 1

Table 6-109 Digital output bits

### 6.2.68.2 Digital outputs polarity

Used to set the polarity of the digital outputs. If a bit is set to “1”, the associated output will be inverted, thus “1” in →“Digital outputs” on page 6-209” will set the output pin low.

For bit description →Table 6-109.

Name	Digital outputs polarity
Index	0x3150
Subindex	0x02
Data type	UNSIGNED16
Access type	RW
Default value	0x0000
Value range	–
PDO mapping	NO
Backup	YES



## 6.2.69 Configuration of digital outputs

Configures the functionality that will be assigned to digital outputs 1 to 3.

Related objects: → “Digital output properties” on page 6-164 / → “Digital outputs” on page 6-209

Name	Configuration of digital outputs
Index	0x3151
Object code	ARRAY
Highest subindex supported	2

### 6.2.69.1 Digital output configuration

Names	Digital output 1 configuration Digital output 2 configuration
Index	0x3151
Subindex	0x01...0x02
Data type	UNSIGNED8
Access type	RW
Default value	→ Table 6-110
Value range	→ Table 6-111
PDO mapping	NO
Backup	YES

Digital output	Default value
DigOut1	16: General purpose A
DigOut2	17: General purpose B

Table 6-110 Digital outputs – Default values

Value	Functionality	Description
255	None	No functionality assigned
254...26	reserved	–
25	Ready/Fault	Active on device ready / inactive on device fault state
24	Holding brake [a]	Output functionality to drive a holding brake (for details → “Holding brake parameters” on page 6-166)
23...18	reserved	–
17	General purpose B	State can be read/written by the host
16	General purpose A	State can be read/written by the host
15...1	reserved	–
0	Set brake (GPIO)	To drive a brake operated by the host in conformance to CiA 402 specification

[a] not available with factory-equipped internal brake

Table 6-111 Digital outputs – Configuration

## 6.2.70 Holding brake parameters

### THE OBJECT CANNOT BE MODIFIED WITH FACTORY-EQUIPPED INTERNAL BRAKE.

Holding brakes are designed to provide protection against unintentional drifting at standstill. They are activated when no torque is applied to the motor. If the controller applies torque to the motor, the holding brake is deactivated (→chapter “2.2 Device Control” on page 2-14).

The functionality can be mapped to any digital output (→“Configuration of digital inputs” on page 6-162). Thereby, take the output current limit into account (for details →separate document «Hardware Reference» of respective controller).

### DESIGN CHARACTERISTICS OF HOLDING BRAKE

- The holding brake is not designed to brake loads. This is done by the controller.
- The holding brake or the motor may be damaged if the holding brake will activate before the motor has reached full standstill. Thus, it is of vital importance to configure the standstill conditions (→“Standstill window configuration” on page 6-159)!
- The holding brake function will only work properly if a main sensor is configured. Otherwise, there is no available information on the motor speed and, as a consequence thereof, there is no possibility to detect standstill →“Standstill window configuration” on page 6-159 and →“Control structure” on page 6-130).

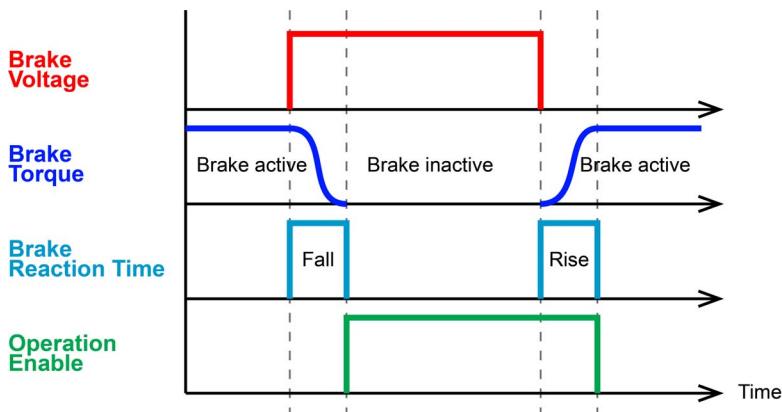

Figure 6-37 Holding brake activation timing (digital output polarity “High active”)

Name	Holding brake parameters
Index	0x3158
Object code	RECORD
Highest subindex supported	3

Continued on next page.

**6.2.70.1 Holding brake rise time**

Indicates the time required from power-off until reaching the holding brake's torque (→Figure 6-37). The value is given in [ms].

Name	Holding brake rise time	
Index	0x3158	
Subindex	0x01	
Data type	UNSIGNED16	
Access type	RW	
Default value	10	
Value range	0	5'000
PDO mapping	NO	
Backup	YES	

**6.2.70.2 Holding brake fall time**

Indicates the time required from power-on until releasing the holding brake's torque (→Figure 6-37). The value is given in [ms].

Name	Holding brake fall time	
Index	0x3158	
Subindex	0x02	
Data type	UNSIGNED16	
Access type	RW	
Default value	10	
Value range	0	5'000
PDO mapping	NO	
Backup	YES	

**6.2.70.3 Holding brake state**

Indicates the state of the holding brake.

Name	Holding brake state	
Index	0x3158	
Subindex	0x03	
Data type	UNSIGNED8	
Access type	RO	
Default value	–	
Value range	→Table 6-112	
PDO mapping	NO	
Backup	NO	

Value	State
0	Inactive
1	Active

Table 6-112 Holding brake states

## 6.2.71 *Analog input properties*

Name	Analog input properties
Index	0x3160
Object code	ARRAY
Highest subindex supported	2

### 6.2.71.1 *Analog input n voltage*

Represents the voltage measured at analog inputs. The value is given in [mV].

Names	Analog input 1 voltage Analog input 2 voltage	
Index	0x3160	
Subindex	0x01...0x02	
Data type	INTEGER16	
Access type	RO	
Default value	-	
Value range	-	-
PDO mapping	TXPDO	
Backup	NO	

## 6.2.72 Configuration of analog inputs

Configures the functionality that will be assigned to analog inputs.

Related objects: → "Analog input properties" on page 6-168

Name	Configuration of analog inputs
Index	0x3161
Object code	ARRAY
Highest subindex supported	2

### 6.2.72.1 Analog input n configuration

Maps functions to analog inputs. Each function can only be mapped once, each analog input can only hold one function.

Names	Analog input 1 configuration Analog input 2 configuration
Index	0x3161
Subindex	0x01...0x02
Data type	UNSIGNED8
Access type	RW
Default value	→ Table 6-113
Value range	→ Table 6-114
PDO mapping	NO
Backup	YES

Analog input	Default value	
	«IDX CANopen» «IDX EtherCAT»	«IDX I/O»
AnIn1	0: General purpose A	8: Set value current
AnIn2	1: General purpose B	9: Set value velocity

Table 6-113 Analog inputs – Default values

Value	Functionality	Description
255	None	No functionality assigned
254...10	reserved	–
9	Set value velocity	
8	Set value current	
7...2	reserved	–
1	General purpose B	Value can be read
0	General purpose A	Value can be read

Table 6-114 Analog inputs – Configuration

### 6.2.73 Analog input general purpose

Displays the actual value measured at the analog inputs. The value is only displayed if the analog input is configured as general purpose. The value is given in [mV].

Related objects: →“Analog input properties” on page 6-168

Name	Analog input general purpose
Index	0x3162
Object code	ARRAY
Highest subindex supported	2

#### 6.2.73.1 Analog input general purpose n

Names	Analog input general purpose A Analog input general purpose B	
Index	0x3162	
Subindex	0x01...0x02	
Data type	INTEGER16	
Access type	RO	
Default value	–	
Value range	–	–
PDO mapping	TXPDO	
Backup	NO	

## 6.2.74 Analog input adjustment

Name	Analog input adjustment
Index	0x3163
Object code	RECORD
Highest subindex supported	4

### 6.2.74.1 Analog input *n* adjustment offset

Represents the adjustment offset voltage of an analog input. The value is given in [mV].

Names	Analog input 1 adjustment offset Analog input 2 adjustment offset	
Index	0x3163	
Subindex	0x01, 0x03	
Data type	INTEGER16	
Access type	RW	
Default value	0	
Value range	-1'000	1'000
PDO mapping	NO	
Backup	YES	

### 6.2.74.2 Analog input *n* adjustment gain factor

Represents the adjustment gain factor of an analog input. The value is given in [1/10000].

Names	Analog input 1 adjustment gain factor Analog input 2 adjustment gain factor	
Index	0x3163	
Subindex	0x02, 0x04	
Data type	UNSIGNED16	
Access type	RW	
Default value	10'000	
Value range	5'000	20'000
PDO mapping	NO	
Backup	YES	

### 6.2.75 Analog input current set value properties

A setpoint function for the analog input. It configures the current set value which is set by an analog input value. The functionality is supported in →“Cyclic Synchronous Torque Mode (CST)” on page 3-41.

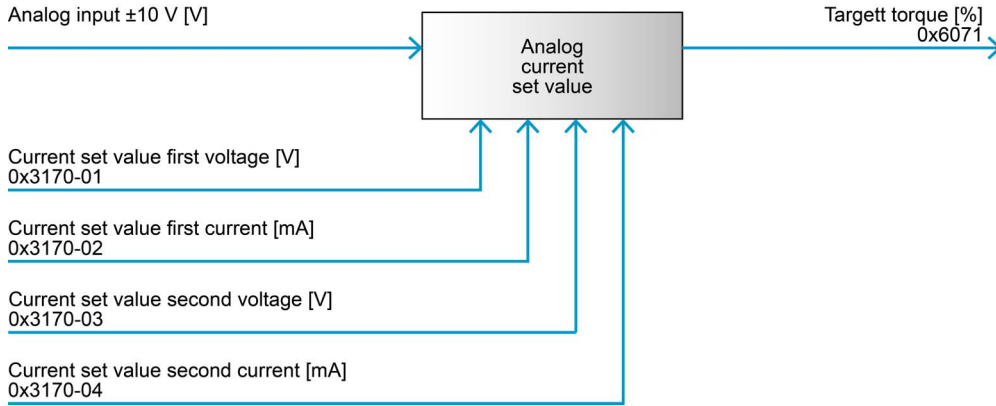

Figure 6-38 Analog input current set value properties – Setpoint function

Name	Analog input current set value properties
Index	0x3170
Object code	ARRAY
Highest subindex supported	4

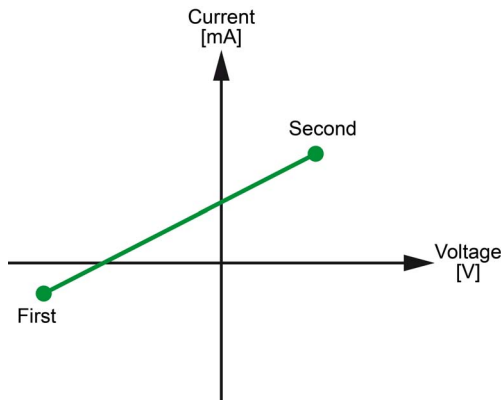

Figure 6-39 Analog input current set value properties – Set value



**6.2.75.1 Current set value first voltage**

Represents the set voltage for the first slope point. The value is given in [mV].

Name	Current set value first voltage	
Index	0x3170	
Subindex	0x01	
Data type	INTEGER32	
Access type	RW	
Default value	0	
Value range	-10'000	+10'000
PDO mapping	NO	
Backup	YES	

**6.2.75.2 Current set value first current**

Represents the output current for the first slope point. The value is given in [mA].

Name	Current set value first current	
Index	0x3170	
Subindex	0x02	
Data type	INTEGER32	
Access type	RW	
Default value	0	
Value range	-Max output current (→Output current limit)	+Max output current (→Output current limit)
PDO mapping	NO	
Backup	YES	

**6.2.75.3 Current set value second voltage**

Represents the set voltage for the second slope point. The value is given in [mV].

Name	Current set value second voltage	
Index	0x3170	
Subindex	0x03	
Data type	INTEGER32	
Access type	RW	
Default value	0	
Value range	-10'000	+10'000
PDO mapping	NO	
Backup	YES	

#### 6.2.75.4 *Current set value second current*

Represents the output current for the second slope point. The value is given in [mA].

Name	Current set value second current	
Index	0x3170	
Subindex	0x04	
Data type	INTEGER32	
Access type	RW	
Default value	0	
Value range	-Output current limit (→Output current limit)	+Output current limit (→Output current limit)
PDO mapping	NO	
Backup	YES	

### 6.2.76 Analog input velocity set value properties

A setpoint function for the analog input. It configures the velocity set value which is set by an analog input value. The functionality is supported in →“Cyclic Synchronous Velocity Mode (CSV)” on page 3-38.

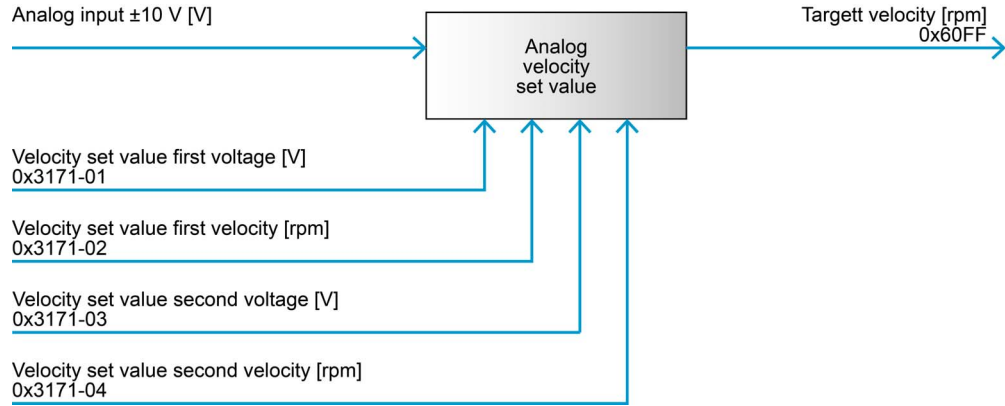

Figure 6-40 Analog input velocity set value properties – Setpoint function

Name	Analog input velocity set value properties
Index	0x3171
Object code	ARRAY
Highest subindex supported	4

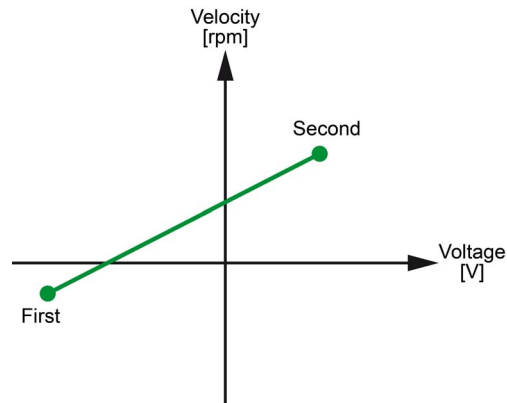

Figure 6-41 Analog input velocity set value properties – Set value

### 6.2.76.1 Velocity set value first voltage

Represents the set voltage for the first slope point. The value is given in [mV].

Name	Velocity set value first voltage	
Index	0x3171	
Subindex	0x01	
Data type	INTEGER32	
Access type	RW	
Default value	0	
Value range	-10'000	+10'000
PDO mapping	NO	
Backup	YES	

### 6.2.76.2 Velocity set value first velocity

Represents the set velocity for the first slope point. The value is given in [velocity units].

Name	Velocity set value first velocity	
Index	0x3171	
Subindex	0x02	
Data type	INTEGER32	
Access type	RW	
Default value	0	
Value range	-100'000 rpm	+100'000 rpm
PDO mapping	NO	
Backup	YES	

### 6.2.76.3 Velocity set value second voltage

Represents the set voltage for the second slope point. The value is given in [mV].

Name	Velocity set value second voltage	
Index	0x3171	
Subindex	0x03	
Data type	INTEGER32	
Access type	RW	
Default value	0	
Value range	-10'000	+10'000
PDO mapping	NO	
Backup	YES	

**6.2.76.4 Velocity set value second velocity**

Represents the set velocity for the second slope point. The value is given in [velocity units].

Name	Velocity set value second velocity	
Index	0x3171	
Subindex	0x04	
Data type	INTEGER32	
Access type	RW	
Default value	0x0000	
Value range	-100'000 rpm	+100'000 rpm
PDO mapping	NO	
Backup	YES	

**6.2.77 Motor protection**

Represents the motor protection parameters.

Name	Motor protection
Index	0x3200
Object code	ARRAY
Highest subindex supported	1

**6.2.77.1 I2t level controller**

Provides the actual thermal state of the internal i2t motor protection feature. The number is given in percent but values higher than 100% are possible.

Name	I2t level controller	
Index	0x3200	
Subindex	0x02	
Data type	UNSIGNED16	
Access type	RO	
Default value	-	
Value range	-	-
PDO mapping	TXPDO	
Backup	NO	

## 6.2.78 Thermal controller protection

Handles the power stage.

Name	Thermal controller protection
Index	0x3201
Object code	ARRAY
Highest subindex supported	2

### 6.2.78.1 Temperature power stage

Displays the power stage temperature. The value is given in [0.1 C°].

Name	Temperature power stage
Index	0x3201
Subindex	0x01
Data type	INTEGER16
Access type	RO
Default value	–
Value range	–
PDO mapping	NO
Backup	NO

### 6.2.78.2 Temperature motor

Displays the motor temperature. If exceeded 125 °C (or with no sensor connected), the error code 0x4380 (→Thermal motor overload error) will be set. The error can be reset with a temperature below 120 °C. The value is given in [0.1 C°].

Name	Temperature motor
Index	0x3201
Subindex	0x02
Data type	INTEGER16
Access type	RO
Default value	–
Value range	–
PDO mapping	NO
Backup	NO

### 6.2.79 Abort connection option code

Specifies the action that will be performed when one of the errors labeled “a” (→“Device Errors” on page 7-221) will be detected. It contains all communication errors.

Some critical errors labeled “d” (→“Device Errors” on page 7-221) always lead to a Disable command even if the fault reaction was not configured to do so.

Related objects: →“Error register” on page 6-63 / →“Fault reaction option code” on page 6-183

Name	Abort connection option code	
Index	0x6007	
Subindex	0x00	
Data type	INTEGER16	
Access type	RW	
Default value	3	
Value range	2	3
PDO mapping	NO	
Backup	YES	

Value	Description
2	«Disable voltage» command
3	«Quick stop» command

Table 6-115 Abort connection option code

### 6.2.80 Error code

Provides the error code of the last error that occurred in the device. This value differs from the value in object →“Error register” on page 6-63. Yet, it is the value that will also appear in object →“Error history” on page 6-64.

Name	Error code	
Index	0x603F	
Subindex	0x00	
Data type	UNSIGNED16	
Access type	RO	
Default value	–	
Value range	–	–
PDO mapping	TXPDO	
Backup	NO	

## 6.2.81 Controlword

Comprises bits for the following items:

- →“Device Control Commands” on page 2-16 (bits 0...3, 7)
- Supervision of operating modes (bits 4...6, 8):
  - “Controlword (Profile Position Mode-specific Bits)” on page 3-23
  - “Controlword (Profile Velocity Mode-specific Bits)” on page 3-26
  - “Controlword (Homing Mode-specific Bits)” on page 3-29

For bit patterns of triggered commands →chapter “2.2.3 Device Control Commands” on page 2-16.

Related objects: →“Statusword” on page 6-181

Name	Controlword
Index	0x6040
Subindex	0x00
Data type	UNSIGNED16
Access type	RW
Default value	–
Value range	–
PDO mapping	RXPDO
Backup	NO

Bit	Description	PPM	PVM	HMM	CSP	CSV	CST
15	Operating mode-specific	Endless movement	reserved	reserved	reserved	reserved	reserved
14...11	reserved						
10, 9	reserved						
8	Operating mode-specific	Halt	Halt	Halt			
7	Fault reset						
6	Operating mode-specific	Abs / rel	reserved	reserved			
5	Operating mode-specific	Change set immediately	reserved	reserved			
4	Operating mode-specific	New setpoint	reserved	Homing operation start			
3	Enable operation						
2	Quick stop						
1	Enable voltage						
0	Switched on						

Table 6-116 Controlword bits



## 6.2.82 Statusword

Comprises bits for the following items:

- → “State of the Drive” on page 2-15 (bits 0..6)
- Operating state of the mode (bits 10, 12 and 13):
  - “Statusword (Profile Position Mode-specific Bits)” on page 3-24
  - “Statusword (Profile Velocity Mode-specific Bits)” on page 3-27
  - “Statusword (Homing Mode-specific Bits)” on page 3-30
  - “Statusword (Cyclic Synchronous Position Mode-specific Bits)” on page 3-37
  - “Statusword (Cyclic Synchronous Velocity Mode-specific Bits)” on page 3-40
  - “Statusword (Cyclic Synchronous Torque Mode-specific Bits)” on page 3-43
- Position referenced to home position (bit 15: will be set on homing attained and will be cleared on a position counter overflow or a position sensor error)
- Internal limit active (bit 11: signals the output current limitation according to I2t method, current derating, or velocity demand is limited in Profile Velocity Mode)
- Remote (bit 9: indicates NMT state is «Operational»)
- Warning (bit 7: indicates the presence of a warning condition)

Related objects: → “Controlword” on page 6-180

Name	Statusword
Index	0x6041
Subindex	0x00
Data type	UNSIGNED16
Access type	RO
Default value	–
Value range	–
PDO mapping	TXPDO
Backup	NO

Bit	Description	PPM	PVM	HMM	CSP	CSV	CST
15	Position referenced to home position						
14	reserved (0)						
13	Operating mode-specific	Following error	Not used	Homing error	Following error		
12	Operating mode-specific	Setpoint acknowledge	Speed	Homing attained	Drive follows command value	Drive follows command value	Drive follows command value
11	Internal limit active		Speed is limited				
10	Operating mode-specific	Target reached	Target reached	Target reached	reserved	reserved	reserved
9	Remote						
8	reserved (0)						
7	Warning						
6	Switch on disabled						
5	Quick stop						
4	Voltage enabled (power stage on)						

Continued on next page.

Bit	Description	PPM	PVM	HMM	CSP	CSV	CST
3	Fault						
2	Operation enabled						
1	Switched on						
0	Ready to switch on						

Table 6-117 Statusword bits

### 6.2.83 Quick stop option code

Indicates the action that will be performed as «Quick stop» is executed.

Name	Quick stop option code		
Index	0x605A		
Subindex	0x00		
Data type	INTEGER16		
Access type	RW		
Default value	6		
Value range	6		6
PDO mapping	NO		
Backup	YES		

Value	Description
6	Decelerate with quick stop ramp and stay in «Quick stop active», enabled

Table 6-118 Quick stop option code

### 6.2.84 Shutdown option code

Indicates the action that will be performed during transition from state «Operation enabled» to states «Ready to switch on» or «Switch on disabled».

Name	Shutdown option code		
Index	0x605B		
Subindex	0x00		
Data type	INTEGER16		
Access type	RW		
Default value	0: without factory-installed internal brake 1: with factory-installed internal brake		
Value range	0		1
PDO mapping	NO		
Backup	YES		

Value	Description
1	Decelerate with slowdown ramp; disabling of the drive function
0	Disable drive function (switch-off the power stage)

Table 6-119 Shutdown option code

### 6.2.85 Disable operation option code

Indicates the action that will be performed during transition from state «Operation enabled» to state «Switched on».

Name	Disable operation option code	
Index	0x605C	
Subindex	0x00	
Data type	INTEGER16	
Access type	RW	
Default value	1	
Value range	0	1
PDO mapping	NO	
Backup	YES	

Value	Description
1	Decelerate with slowdown ramp; disabling of the drive function
0	Disable drive function (switch-off the power stage)

Table 6-120 Disable operation option code

### 6.2.86 Fault reaction option code

Specifies the action to be performed if one of the errors labeled “f” in the →“Device Errors” on page 7-221 will be detected. It contains most errors except communication errors (handled as to →“Abort connection option code” on page 6-179).

Some critical errors (labeled “d” (→“Device Errors” on page 7-221) always lead to a disable command even if the fault reaction was not configured to do so.

Related objects: →“Error register” on page 6-63 / →“Abort connection option code” on page 6-179

Name	Fault reaction option code	
Index	0x605E	
Subindex	0x00	
Data type	INTEGER16	
Access type	RW	
Default value	2	
Value range	0	2
PDO mapping	NO	
Backup	YES	

Value	Description
2	Slow down with quick stop ramp
1	Slow down with slowdown ramp
0	Disable drive function

Table 6-121 Fault reaction option code

### 6.2.87 Modes of operation

Switches the actually chosen operating mode. We recommend to use →Modes of operation display after changing the operation mode.

Related objects: →“Modes of operation display” on page 6-184

Name	Modes of operation
Index	0x6060
Subindex	0x00
Data type	INTEGER8
Access type	RW
Default value	1
Value range	→Table 6-122
PDO mapping	RXPDO
Backup	YES

Operation mode	Description
1	→Profile Position Mode (PPM) [a]
3	→Profile Velocity Mode (PVM) [a]
6	→Homing Mode (HMM) [a]
8	→Cyclic Synchronous Position Mode (CSP) [a]
9	→Cyclic Synchronous Velocity Mode (CSV)
10	→Cyclic Synchronous Torque Mode (CST)
[a] not available with «IDX I/O»	

Table 6-122 Modes of operation

### 6.2.88 Modes of operation display

Displays the actual mode of operation. The meaning of the returned value corresponds to the code in →Table 6-122.

Related objects: →“Modes of operation” on page 6-184

Name	Modes of operation display
Index	0x6061
Subindex	0x00
Data type	INTEGER8
Access type	RO
Default value	–
Value range	→Table 6-122
PDO mapping	TXPDO
Backup	NO

### 6.2.89 Position demand value

**THE OBJECT IS ONLY AVAILABLE FOR «IDX CANOPEN» AND «IDX ETHERCAT».**

Used as input for the position controller. For profiled motions, the value is generated by the profile generator. The value is given in [position units] (→page 2-17).

Name	Position demand value	
Index	0x6062	
Subindex	0x00	
Data type	INTEGER32	
Access type	RO	
Default value	–	
Value range	–	–
PDO mapping	TXPDO	
Backup	NO	

### 6.2.90 Position actual value

Provides the actual position value of the axis, derived by the main sensor defined in →“Axis configuration” on page 6-129. The value is given in [position units] (→page 2-17).

As soon as a homing procedure is successfully performed, the value is absolute and referenced which is indicated by the «Position referenced to home position» bit →“Statusword” on page 6-181.

Name	Position actual value	
Index	0x6064	
Subindex	0x00	
Data type	INTEGER32	
Access type	RO	
Default value	–	
Value range	–	–
PDO mapping	TXPDO	
Backup	NO	

### 6.2.91 Following error window

**THE OBJECT IS ONLY AVAILABLE FOR «IDX CANOPEN» AND «IDX ETHERCAT».**

Represents the maximal permitted difference between →“Position actual value” on page 6-185 and →“Position demand value” on page 6-185. If exceeded, a following error will occur. The value is given in [position units] (→page 2-17).

Name	Following error window	
Index	0x6065	
Subindex	0x00	
Data type	UNSIGNED32	
Access type	RW	
Default value	2000	
Value range	–	–
PDO mapping	RXPDO	
Backup	YES	

### 6.2.92 Following error timeout

**THE OBJECT IS ONLY AVAILABLE FOR «IDX CANOPEN» AND «IDX ETHERCAT».**

Indicates the configured time for a following error condition. If exceeded, a following error will occur. The value is given in milliseconds [ms].

Name	Following error timeout	
Index	0x6066	
Subindex	0x00	
Data type	UNSIGNED16	
Access type	RW	
Default value	0	
Value range	0	0
PDO mapping	RXPDO	
Backup	NO	

### 6.2.93 Velocity demand value

Used as input for the position controller. For profiled moves, the value is generated by the profile generator. The value is given in [velocity units] (→page 2-17).

Name	Velocity demand value	
Index	0x606B	
Subindex	0x00	
Data type	INTEGER32	
Access type	RO	
Default value	–	
Value range	–	–
PDO mapping	TXPDO	
Backup	NO	

### 6.2.94 Velocity actual value

Provides the actual velocity value of the axis derived by the main sensor defined in →“Axis configuration” on page 6-129. The value is given in [velocity units] (→page 2-17).

Related objects: →“Velocity actual value averaged” on page 6-158

Name	Velocity actual value	
Index	0x606C	
Subindex	0x00	
Data type	INTEGER32	
Access type	RO	
Default value	–	
Value range	–	–
PDO mapping	TXPDO	
Backup	NO	

### 6.2.95 Target torque

Indicates the configured input value for the torque controller in Cyclic Synchronous Torque Mode. The value is given in per thousand of →“Motor rated torque” on page 6-187).

Related objects: →“Motor rated torque” on page 6-187

Name	Target torque
Index	0x6071
Subindex	0x00
Data type	INTEGER16
Access type	RW
Default value	0
Value range	–
PDO mapping	RXPDO
Backup	NO

### 6.2.96 Motor rated torque

Holds the value to which all torque objects are related to. The value is defined as «Nominal current» multiplied by the «Torque constant». The value is given in [ $\mu\text{Nm}$ ].

Changing the value by write access is not permitted.

Related objects: →“Motor data” on page 6-134

Name	Motor rated torque
Index	0x6076
Subindex	0x00
Data type	UNSIGNED32
Access type	RW
Default value	Device-specific
Value range	–
PDO mapping	NO
Backup	NO

### 6.2.97 Torque actual value

Provides the actual torque and corresponds to the motor’s instantaneous torque. The value is given in per thousand of →“Motor rated torque” on page 6-187).

Related objects: →“Motor rated torque” on page 6-187

Name	Torque actual value
Index	0x6077
Subindex	0x00
Data type	INTEGER16
Access type	RO
Default value	–
Value range	–
PDO mapping	TXPDO
Backup	NO

## 6.2.98 Target position

**THE OBJECT IS ONLY AVAILABLE FOR «IDX CANOPEN» AND «IDX ETHERCAT».**

Used as input for the profile generator during profiled moves. Represents the position that the drive is supposed to move using the motion control parameters (such as velocity, acceleration, and deceleration). For non-profiled moves, the target position is directly used as input for the position controller. The value is given in [position units] (→page 2-17).

The target position is not set until the command is given by the →“Controlword” on page 6-180. In this case, the target position will be interpreted as absolute or relative depending on the command set to the controlword. Otherwise, the target position is interpreted as absolute value.

Related objects: →“Profile velocity” on page 6-192 / →“Profile acceleration” on page 6-193

Name	Target position
Index	0x607A
Subindex	0x00
Data type	INTEGER32
Access type	RW
Default value	0
Value range	–
PDO mapping	RXPDO
Backup	NO



## 6.2.99 Position range limit

**THE OBJECT IS ONLY AVAILABLE FOR «IDX CANOPEN» AND «IDX ETHERCAT».**

For the time being, the value range of both objects is limited to the value of "0" (zero) meaning that the functionality of both objects →Min position range limit (0x607B/0x01) and →Max position range limit (0x607B/0x02) is disabled. A «Value range error» (abort code 0x0609 0030) will be reported in case of writing a value other than "0" (zero).

If you should require a way to implement a limitation of the motion range, you might wish to configure the →Software position limit (0x607D), instead.

Name	Position range limit
Index	0x607B
Object code	ARRAY
Highest subindex supported	2

### 6.2.99.1 Min position range limit

Defines the minimum position range limit by limiting the →Position demand value. Upon reaching or exceeding this limit, the input value automatically skips to the other end of the range. The value is given in [position units] (→page 2-17).

A value of "0" (zero) disables the minimum position range limit check.

Related objects: →"Position demand value" on page 6-185

Name	Min position range limit
Index	0x607B
Subindex	0x01
Data type	INTEGER32
Access type	RW
Default value	0
Value range	0 0
PDO mapping	RXPDO
Backup	NO

### 6.2.99.2 Max position range limit

Defines the maximum position range limit by limiting the →Position demand value. Upon reaching or exceeding this limit, the input value automatically skips to the other end of the range. The value is given in [position units] (→page 2-17).

A value of "0" (zero) disables the maximum position range limit check.

Related objects: →"Position demand value" on page 6-185

Name	Max position range limit
Index	0x607B
Subindex	0x02
Data type	INTEGER32
Access type	RW
Default value	0
Value range	0 0
PDO mapping	RXPDO
Backup	YES

## 6.2.100 Software position limit

**THE OBJECT IS ONLY AVAILABLE FOR «IDX CANOPEN» AND «IDX ETHERCAT».**

Defines the min/max position values for the actual position value and the demand position value. An error is launched if the actual position value or the demand position value exceed their limits.

In PPM, the new target position is limited to the min/max position limit.

The software position limit supervision is inactive in Homing Mode (HMM).

Name	Software position limit
Index	0x607D
Object code	ARRAY
Highest subindex supported	2

### 6.2.100.1 Min position limit

Defines the absolute negative position limit for the →Position demand value or the →Position actual value. The value is given in [position units] (→page 2-17).

If the desired or the actual position is lower than the negative position limit, a software position limit error will be launched.

If the value of Min position limit and Max position limit is "0" (zero), the position limit check is disabled.

Related objects: →"Position demand value" on page 6-185 / →"Position actual value" on page 6-185

Name	Min position limit	
Index	0x607D	
Subindex	0x01	
Data type	INTEGER32	
Access type	RW	
Default value	0	
Value range	-2'147'483'648	2'147'483'647
PDO mapping	RXPDO	
Backup	YES	

### 6.2.100.2 Max position limit

Defines the absolute positive position limit for the →Position demand value or the →Position actual value. The value is given in [position units] (→page 2-17).

If the desired or the actual position is higher than the positive position limit, a software position limit error will be launched.

If the value of Min position limit and Max position limit is "0" (zero), position limit check is disabled.

Related objects: →"Position demand value" on page 6-185 / →"Position actual value" on page 6-185

Name	Max position limit	
Index	0x607D	
Subindex	0x02	
Data type	INTEGER32	
Access type	RW	
Default value	0	
Value range	-2'147'483'648	2'147'483'647
PDO mapping	RXPDO	
Backup	YES	

### 6.2.101 Max profile velocity

Used as velocity limit in a PPM or PVM move. The value is given in [velocity units] (→page 2-17).

Related objects: →"Profile velocity" on page 6-192 / →"Homing speeds" on page 6-195 / →"Max motor speed" on page 6-192 / →"Target velocity" on page 6-210 / →"Max gear input speed" on page 6-138 / →"Axis configuration" on page 6-129 / →"Max system speed" on page 6-133

Name	Max profile velocity	
Index	0x607F	
Subindex	0x00	
Data type	UNSIGNED32	
Access type	RW	
Default value	50'000	
Value range	1	→Max system speed
PDO mapping	RXPDO	
Backup	YES	

### 6.2.102 Max motor speed

Indicates the configured maximal allowed speed for the motor. It serves as protection of the motor. The value is given in [rpm] (→page 2-17).

For detailed motor specifications →maxon catalog.

Related objects: →“Motor type” on page 6-210 / →“Number of pole pairs” on page 6-135 / →“Max profile velocity” on page 6-191 / →“Target velocity” on page 6-210 / →“Max gear input speed” on page 6-138 / →“Max system speed” on page 6-133

Name	Max motor speed	
Index	0x6080	
Subindex	0x00	
Data type	UNSIGNED32	
Access type	RW	
Default value	Device-specific	
Value range	1	Device-specific / max. 100'000 rpm per pole pair
PDO mapping	RXPDO	
Backup	YES	

### 6.2.103 Profile velocity

**THE OBJECT IS ONLY AVAILABLE FOR «IDX CANOPEN» AND «IDX ETHERCAT».**

Represents the velocity normally attained at the end of the acceleration ramp during a profiled move (PPM, PVM). The value is given in [velocity units] (→page 2-17).

Related objects: →“Max profile velocity” on page 6-191

Name	Profile velocity	
Index	0x6081	
Subindex	0x00	
Data type	UNSIGNED32	
Access type	RW	
Default value	1000	
Value range	1	→Max profile velocity
PDO mapping	RXPDO	
Backup	YES	

### 6.2.104 Profile acceleration

Defines the acceleration value used during a profiled move. The value is given in [acceleration units] (→page 2-17).

Name	Profile acceleration	
Index	0x6083	
Subindex	0x00	
Data type	UNSIGNED32	
Access type	RW	
Default value	10'000	
Value range	1	→Max acceleration
PDO mapping	RXPDO	
Backup	YES	

### 6.2.105 Profile deceleration

Defines the deceleration value used during a profiled move. The value is given in [acceleration units] (→page 2-17).

Name	Profile deceleration	
Index	0x6084	
Subindex	0x00	
Data type	UNSIGNED32	
Access type	RW	
Default value	10'000	
Value range	1	→Max acceleration
PDO mapping	RXPDO	
Backup	YES	

### 6.2.106 Quick stop deceleration

Used with a «Quick stop» command to determine the deceleration of the quick stop profile. The value is given in [acceleration units] (→page 2-17).

Related objects: →“Controlword” on page 6-180 / →“Fault reaction option code” on page 6-183 / →“Abort connection option code” on page 6-179

Name	Quick stop deceleration	
Index	0x6085	
Subindex	0x00	
Data type	UNSIGNED32	
Access type	RW	
Default value	10'000	
Value range	1	→Max acceleration
PDO mapping	RXPDO	
Backup	YES	

### 6.2.107 Motion profile type

**THE OBJECT IS ONLY AVAILABLE FOR «IDX CANOPEN» AND «IDX ETHERCAT».**

Selects the type of motion profile trajectory used in →“Profile Position Mode (PPM)” on page 3-21, →“Homing Mode (HMM)” on page 3-28, or →“Profile Velocity Mode (PVM)” on page 3-25.

Name	Motion profile type	
Index	0x6086	
Subindex	0x00	
Data type	INTEGER16	
Access type	RW	
Default value	0	
Value range	→Table 6-123	–
PDO mapping	RXPDO	
Backup	YES	

Value	Description
0	linear ramp (trapezoidal profile)

Table 6-123 Motion profile types

### 6.2.108 Homing method

**THE OBJECT IS ONLY AVAILABLE FOR «IDX CANOPEN» AND «IDX ETHERCAT».**

Used to select the desired homing method.

If the homing method is changed during an ongoing homing process, it will not come into effect before the next homing process is started.

Name	Homing method	
Index	0x6098	
Subindex	0x00	
Data type	INTEGER8	
Access type	RW	
Default value	23	
Value range	–	–
PDO mapping	RXPDO	
Backup	YES	

Value	Description
37	→Homing Method 37 (Actual Position)
27	→Homing Method 27 (Home Switch Negative Speed)
23	→Homing Method 23 (Home Switch Positive Speed)
18	→Homing Method 18 (Positive Limit Switch)
17	→Homing Method 17 (Negative Limit Switch)
-3	→Homing Method -3 (Current Threshold Positive Speed)
-4	→Homing Method -4 (Current Threshold Negative Speed)

Table 6-124 Homing methods

## 6.2.109 Homing speeds

**THE OBJECT IS ONLY AVAILABLE FOR «IDX CANOPEN» AND «IDX ETHERCAT».**

Used to search a limit switch in a homing sequence. The value is given in [velocity units] (→page 2-17).

Related objects: →“Max profile velocity” on page 6-191

Name	Homing speeds
Index	0x6099
Object code	ARRAY
Highest subindex supported	2

### 6.2.109.1 Speed for switch search

Name	Speed for switch search
Index	0x6099
Subindex	0x01
Data type	UNSIGNED32
Access type	RW
Default value	100
Value range	1 →Max profile velocity
PDO mapping	RXPDO
Backup	YES

### 6.2.109.2 Speed for zero search

Used to search the index in a homing sequence. The value is given in [velocity units] (→page 2-17).

Name	Speed for zero search
Index	0x6099
Subindex	0x02
Data type	UNSIGNED32
Access type	RW
Default value	10
Value range	1 →Max profile velocity
PDO mapping	RXPDO
Backup	YES

### 6.2.110 Homing acceleration

**THE OBJECT IS ONLY AVAILABLE FOR «IDX CANOPEN» AND «IDX ETHERCAT».**

Used to define acceleration and deceleration ramps in the homing profile. The value is given in [acceleration units] (→page 2-17).

Related objects: →“Max acceleration” on page 6-204

Name	Homing acceleration		
Index	0x609A		
Subindex	0x00		
Data type	UNSIGNED32		
Access type	RW		
Default value	1000		
Value range	1	→Max acceleration	
PDO mapping	RXPDO		
Backup	YES		

### 6.2.111 SI unit position

Defines the position units. Coding of the user-defined units and prefixes follows →chapter “2.3.1 SI Units” on page 2-17.

Write access is only permitted in device state «Power Disable».

Name	SI unit position
Index	0x60A8
Subindex	0x00
Data type	UNSIGNED32
Access type	RW
Default value	0x00B50000
Value range	→Table 6-126
PDO mapping	NO
Backup	YES

Bit 31...24	Bit 23...16	Bit 15...8	Bit 7...0
Prefix	Numerator	Denominator	reserved (0)

Table 6-125 SI units position – Bits

Value	Description	Symbol
0x00B50000	Increments	inc

Table 6-126 SI units position – Value range



## 6.2.112 SI unit velocity

Defines the velocity units. Coding of the user-defined units and prefixes follows → chapter “2.3.1 SI Units” on page 2-17.

Write access is only permitted in device state «Power Disable».

Name	SI unit velocity
Index	0x60A9
Subindex	0x00
Data type	UNSIGNED32
Access type	RW
Default value	0x00B44700
Value range	→ Table 6-128
PDO mapping	NO
Backup	YES

Bit 31...24	Bit 23...16	Bit 15...8	Bit 7...0
Prefix	Numerator	Denominator	reserved (0)

Table 6-127 SI units velocity – Bits

Value	Description	Symbol
0x00B44700	Revolutions/minute	rev/min (rpm)
0xFFB44700	0.1 revolutions/minute	deci rev/min (drpm)
0xFEB44700	0.01 revolutions/minute	centi rev/min (crpm)
0xFDB44700	0.001 revolutions/minute	milli rev/min (mrpm)
0xFCB44700	0.0001 revolutions/minute	10 <sup>-4</sup> rev/min (10 <sup>-4</sup> rpm)
0xFBB44700	0.00001 revolutions/minute	10 <sup>-5</sup> rev/min (10 <sup>-5</sup> rpm)
0xFAB44700	0.000001 revolutions/minute	micro rev/min (μrpm)

Table 6-128 SI units velocity – Value range

### 6.2.113 SI unit acceleration

Defines the acceleration units. Coding of the user-defined units and prefixes follows →chapter “2.3.1 SI Units” on page 2-17.

Write access is only permitted in device state «Power Disable».

Name	SI unit acceleration
Index	0x60AA
Subindex	0x00
Data type	UNSIGNED32
Access type	RW
Default value	0x00C00300
Value range	→Table 6-130
PDO mapping	NO
Backup	YES

Bit 31...24	Bit 23...16	Bit 15...8	Bit 7...0
Prefix	Numerator	Denominator	reserved (0)

Table 6-129 SI units acceleration – Bits

Value	Description	Symbol
0x00C00300	(Revolutions/minute)/second	rpm/s

Table 6-130 SI units acceleration – Value range

### 6.2.114 Position offset

**THE OBJECT IS ONLY AVAILABLE FOR «IDX CANOPEN» AND «IDX ETHERCAT».**

Provides the offset of the position. The value is given in [increments].

- In CSP, the object contains the commanded additive position of the drive which is then added to the →Target position.

Related objects: →“Target position” on page 6-188

Name	Position offset
Index	0x60B0
Subindex	0x00
Data type	INTEGER32
Access type	RW
Default value	0
Value range	–
PDO mapping	RXPDO
Backup	NO

### 6.2.115 Velocity offset

In CSV, the object provides the offset towards the →Target velocity. The value itself is absolute but, since it represents an additive velocity value, it also can be used to control the drive with relative values in respect to the →Target velocity. The value is given in [velocity units] (→page 2-17).

Name	Velocity offset
Index	0x60B1
Subindex	0x00
Data type	INTEGER32
Access type	RW
Default value	0
Value range	–
PDO mapping	RXPDO
Backup	NO

### 6.2.116 Torque offset

Provides the offset of the torque. The value is given in per thousand of →“Motor rated torque” on page 6-187.

- In CSP, the object contains the input value for torque feed forward.
- In CST, the object contains the commanded additive torque of the drive which is then added to the →Target torque.

Related objects: →“Target torque” on page 6-187

Name	Torque offset
Index	0x60B2
Subindex	0x00
Data type	INTEGER16
Access type	RW
Default value	0
Value range	–
PDO mapping	RXPDO
Backup	NO

## 6.2.117 Touch probe function

**THE OBJECT IS ONLY AVAILABLE FOR «IDX CANOPEN» AND «IDX ETHERCAT».**

Configures the touch probe function. Consider →“Digital Input Timing Behavior” on page 4-51 and take note that the touch probe function and Homing Mode cannot be used at the same time. After homing, all touch probe states and latched positions are cleared.

Related objects: →“Configuration of digital inputs” on page 6-162

Name	Touch probe function
Index	0x60B8
Subindex	0x00
Data type	UNSIGNED16
Access type	RW
Default value	0
Value range	→Table 6-131
PDO mapping	RXPDO
Backup	NO

Bit	Value	Description
15...6	–	reserved
5	1	Enable sampling a negative edge touch probe 1
	0	Switch off sampling a negative edge touch probe 1
4	1	Enable sampling a positive edge touch probe 1
	0	Switch off sampling a positive edge touch probe 1
3; 2 [a]	11	reserved
	10	Touch probe source defined by object 0x60D0-01
	01	reserved
	00	Trigger on touch probe (input mapped to touch probe 1)
1	1	Continuous
	0	Trigger first event
0	1	Enable touch probe 1
	0	Switch off touch probe 1

[a] Configuring bits 3 or 2 with either values 00 or 10 results in the same behavior.

Table 6-131 Touch probe function

### 6.2.118 Touch probe status

**THE OBJECT IS ONLY AVAILABLE FOR «IDX CANOPEN» AND «IDX ETHERCAT».**

Provides the status of the touch probe. Status information of the touch probe shall first be evaluated by the control device to check whether the stored touch probe values (→Touch probe position 1 positive value and →Touch probe position 1 negative value) are valid.

Related objects: →“Touch probe position 1 positive value” on page 6-201 / →“Touch probe position 1 negative value” on page 6-202

Name	Touch probe status
Index	0x60B9
Subindex	0x00
Data type	UNSIGNED16
Access type	RO
Default value	0
Value range	→Table 6-132
PDO mapping	TXPDO
Backup	NO

Bit	Value	Description
15...3	–	reserved
2	1	Touch probe 1, negative edge position stored
	0	Touch probe 1, no negative edge position stored
1	1	Touch probe 1, positive edge position stored
	0	Touch probe 1, no positive edge position stored
0	1	Touch probe 1 enabled
	0	Touch probe 1 switched off

Table 6-132 Touch probe status

### 6.2.119 Touch probe position 1 positive value

**THE OBJECT IS ONLY AVAILABLE FOR «IDX CANOPEN» AND «IDX ETHERCAT».**

Provides the position value of the touch probe 1 at positive edge detection. The object is only valid if the position is stored (→Touch probe status; bit 1). The value is given in [position units] (→“System Units” on page 2-17)

Related objects: →“Touch probe status” on page 6-201

Name	Touch probe position 1 positive value
Index	0x60BA
Subindex	0x00
Data type	INTEGER32
Access type	RO
Default value	–
Value range	–
PDO mapping	TXPDO
Backup	NO

### 6.2.120 *Touch probe position 1 negative value*

**THE OBJECT IS ONLY AVAILABLE FOR «IDX CANOPEN» AND «IDX ETHERCAT».**

Provides the position value of the touch probe 1 at negative edge detection. The object is only valid if the position is stored (→Touch probe status; bit 1). The value is given in [position units] (→“System Units” on page 2-17)

Related objects:→“Touch probe status” on page 6-201

Name	Touch probe position 1 negative value	
Index	0x60BB	
Subindex	0x00	
Data type	INTEGER32	
Access type	RO	
Default value	–	
Value range	–	–
PDO mapping	TXPDO	
Backup	NO	

## 6.2.121 Interpolation time period

THE OBJECT IS ONLY AVAILABLE FOR «IDX CANOPEN» AND «IDX ETHERCAT».

Name	Interpolation time period
Index	0x60C2
Object code	RECORD
Highest subindex supported	2

### 6.2.121.1 Interpolation time period value

Indicates the time between two PDOs. Values > "0" (zero) enable the demand value interpolation in CSP and CSV. It is of importance that the setpoint (→Target position, →Position offset, →Target velocity, →Velocity offset) is written cyclically with the interpolation time period.

The value is given in  $[s \cdot 10^{\text{interpolation time index}}]$ . An →Interpolation time index of value -3 indicates that the interpolation time period value is given in milliseconds.

The value "0" (zero) disables the demand value interpolation.



#### Best Practice

The «Interpolation time period value» must be configured to correspond with the master's synchronized PDO command cycle that updates the CSP set value, respectively the CSV set value.

If a value of "0" (zero) is configured, the device immediately takes the new set value and adapts the position (in case of CSP mode), respectively the velocity (in case of CSV mode) to it within the next control cycle (i.e. 0.4 ms). Afterwards it holds this set value until the next set value of the master is received. This results in an interrupted and noisy motion if the master just provides new set values at cycle rates of 1 ms, 2 ms, or even lower.

If the «Interpolation time period value» is configured properly based on the master's PDO cycle time, the device interpolates the new set value in between the period. This results in a smooth motion and less noisy control result.

Name	Interpolation time period value	
Index	0x60C2	
Subindex	0x01	
Data type	UNSIGNED8	
Access type	RW	
Default value	0	
Value range	0	100
PDO mapping	RXPDO	
Backup	YES	

### 6.2.121.2 Interpolation time index

Defines the unit of the →Interpolation time period value. The value -3 corresponds to the unit [ms].

Name	Interpolation time index	
Index	0x60C2	
Subindex	0x02	
Data type	INTEGER8	
Access type	RW	
Default value	-3	
Value range	-3	-3
PDO mapping	RXPDO	
Backup	YES	

### 6.2.122 Max acceleration

Used to limit the maximal allowed acceleration to prevent mechanical damage. It represents the limit of all other acceleration/deceleration objects of the axis. The value is given in [acceleration units] (→page 2-17). In cyclic modes (CSP, CSV, CST), the object is not taken into account.

Related objects: →“Profile acceleration” on page 6-193 / →“Profile deceleration” on page 6-193 / →“Quick stop deceleration” on page 6-193 / →“Homing acceleration” on page 6-196

Name	Max acceleration	
Index	0x60C5	
Subindex	0x00	
Data type	UNSIGNED32	
Access type	RW	
Default value	4'294'967'295	
Value range	1	4'294'967'295
PDO mapping	RXPDO	
Backup	YES	



### 6.2.123 Touch probe source

**THE OBJECT IS ONLY AVAILABLE FOR «IDX CANOPEN» AND «IDX ETHERCAT».**

Defines the source of the touch probe functions.

Name	Touch probe source
Index	0x60D0
Object code	ARRAY
Highest subindex supported	1

#### 6.2.123.1 Touch probe 1 source

Defines the source of the touch probe 1 functions.

Name	Touch probe 1 source
Index	0x60D0
Subindex	0x01
Data type	INTEGER16
Access type	RO
Default value	–
Value range	→ Table 6-133
PDO mapping	NO
Backup	YES

Value	Description
5	Hardware index impulse signal of main sensor
4	Digital input 4
3	Digital input 3
2	Digital input 2
1	Digital input 1

Table 6-133 Touch probe 1 source

### 6.2.124 Touch probe 1 positive edge counter

**THE OBJECT IS ONLY AVAILABLE FOR «IDX CANOPEN» AND «IDX ETHERCAT».**

Provides a continuous counter being incremented with each positive edge at touch probe 1. The counter is only valid if the sampling of the positive edge is enabled (→ Touch probe status; bit 0 and bit 4) and cleared when the touch probe is disabled.

Related objects: → “Touch probe status” on page 6-201

Name	Touch probe 1 positive edge counter
Index	0x60D5
Subindex	0x00
Data type	UNSIGNED16
Access type	RO
Default value	–
Value range	→ Table 6-134
PDO mapping	TXPDO
Backup	NO

Probe mode	Value range
Single event	0...1
Continuous	0...65'535 (with overflow)

Table 6-134 Touch probe 1 positive edge counter

### 6.2.125 Touch probe 1 negative edge counter

**THE OBJECT IS ONLY AVAILABLE FOR «IDX CANOPEN» AND «IDX ETHERCAT».**

Provides a continuous counter being incremented with each negative edge at touch probe 1. The counter is only valid if the sampling of the negative edge is enabled (→ Touch probe status; bit 0 and bit 4) and cleared when the touch probe is disabled.

Related objects: → “Touch probe status” on page 6-201

Name	Touch probe 1 negative edge counter
Index	0x60D6
Subindex	0x00
Data type	UNSIGNED16
Access type	RO
Default value	–
Value range	→ Table 6-135
PDO mapping	TXPDO
Backup	NO

Probe mode	Value range
Single event	0...1
Continuous	0...65'535 (with overflow)

Table 6-135 Touch probe 1 negative edge counter

### 6.2.126 Following error actual value

**THE OBJECT IS ONLY AVAILABLE FOR «IDX CANOPEN» AND «IDX ETHERCAT».**

Represents the actual value of the following error. The value is given in [position units] (→page 2-17).

Name	Following error actual value	
Index	0x60F4	
Subindex	0x00	
Data type	INTEGER32	
Access type	RO	
Default value	–	
Value range	–	–
PDO mapping	TXPDO	
Backup	NO	

## 6.2.127 Digital inputs

Displays the state of the digital input functionalities (after polarity correction by →“Digital input properties” on page 6-161; Polarity). A bit is read as “1” if the signal at the corresponding pin is high.

Related objects: →“Digital input properties” on page 6-161 / →“Configuration of digital inputs” on page 6-162

Name	Digital inputs	
Index	0x60FD	
Subindex	0x00	
Data type	UNSIGNED32	
Access type	RO	
Default value	–	
Value range	–	–
PDO mapping	TXPDO	
Backup	NO	

Bit	Functionality	Description
31...29	reserved	–
28	Quick stop	Stop movement and switch to «Quick stop active» state (→“Device Control” on page 2-14 for valid transitions)
27	Drive enable	Enable/disable the drive or clear errors in «Fault» state (→“Device Control” on page 2-14 for valid transitions)
26	Touch probe	Samples actual position
25	Positive limit switch without errors [a]	Used in some homing modes / does not generate limit errors
24	Negative limit switch without errors [a]	Used in some homing modes / does not generate limit errors
23...20	reserved	–
19	General purpose D	State can be read
18	General purpose C	State can be read
17	General purpose B	State can be read
16	General purpose A	State can be read
15...3	reserved	–
2	Home switch [a]	Used in some homing modes
1	Positive limit switch [a]	Used in some homing modes / generates limit error
0	Negative limit switch [a]	Used in some homing modes / generates limit error
[a] not available with «IDX I/O»		

Table 6-136 Digital inputs

### 6.2.128 Digital outputs

Configures the state of the digital output functionalities (before polarity correction by →“Digital output properties” on page 6-164; Polarity). If a bit is set to “1” and the polarity bit is set to “0” (zero), the signal at the corresponding pin is high.

Related objects: →“Digital output properties” on page 6-164 / →“Configuration of digital outputs” on page 6-165

Name	Digital outputs
Index	0x60FE
Object code	ARRAY
Highest subindex supported	1

#### 6.2.128.1 Physical outputs

Name	Physical outputs
Index	0x60FE
Subindex	0x01
Data type	UNSIGNED32
Access type	Bit 0...23: RW / Bit 24...31: RO
Default value	0
Value range	–
PDO mapping	RXPDO
Backup	NO

Bit	Functionality	Description
31...26	reserved	–
25	Ready/Fault	Active on device ready / inactive on device fault state
24	Holding brake [a]	Output functionality to drive a holding brake (for details →“Holding brake parameters” on page 6-166)
23...18	reserved	–
17	General purpose B	State can be read/written by the host
16	General purpose A	State can be read/written by the host
15...1	reserved	–
0	Set brake (GPIO)	–

[a] not available with factory-equipped internal brake

Table 6-137 Digital outputs

### 6.2.129 Target velocity

In Profile Velocity Mode (PVM), the object indicates the configured target velocity and is used as input for the trajectory generator. The value is given in [velocity units] (→page 2-17).

Related objects: →“Max profile velocity” on page 6-191 / →“Max motor speed” on page 6-192 / →“Profile acceleration” on page 6-193 / →“Profile deceleration” on page 6-193

Name	Target velocity	
Index	0x60FF	
Subindex	0x00	
Data type	INTEGER32	
Access type	RW	
Default value	0	
Value range	–	–
PDO mapping	RXPDO	
Backup	NO	

### 6.2.130 Motor type

Defines the motor type of the axis.

Related objects: →“Axis configuration” on page 6-129 / →“Motor data” on page 6-134

Name	Motor type	
Index	0x6402	
Subindex	0x00	
Data type	UNSIGNED16	
Access type	RW	
Default value	10	
Value range	→Table 6-138	
PDO mapping	NO	
Backup	YES	

Value	DS-402 Name	Description
10	Sinusoidal PM BL motor	Brushless DC motor BLDC sinus commutated (maxon EC motor)

Table 6-138 Motor types

### 6.2.131 Supported drive modes

Provides an overview of the implemented operating modes in the device. Supported are the following modes whereby marked “[a]” are not available with «IDX I/O»:

- →Profile Position Mode (PPM) [a]
- →Profile Velocity Mode (PVM) [a]
- →Homing Mode (HMM) [a]
- →Cyclic Synchronous Position Mode (CSP) [a]
- →Cyclic Synchronous Velocity Mode (CSV)
- →Cyclic Synchronous Torque Mode (CST)

Name	Supported drive modes	
Index	0x6502	
Subindex	0x00	
Data type	UNSIGNED32	
Access type	RO	
Default value	–	
Value range	–	–
PDO mapping	TXPDO	
Backup	NO	

Bit		Description
31...11	0	reserved
10	0	Cyclic Synchronous Torque Mode With Commutation Angle
9	1	Cyclic Synchronous Torque Mode (CST)
8	1	Cyclic Synchronous Velocity Mode (CSV)
7	1	Cyclic Synchronous Position Mode (CSP)
6	0	Interpolated Position Mode (IPM)
5	1	Homing Mode (HMM)
4	0	reserved
3	0	Torque Mode
2	1	Profile Velocity Mode (PVM)
1	0	Velocity Mode
0	1	Profile Position Mode (PPM)

Table 6-139 Supported drive modes – Bits

## 6.2.132 Modular device profile

**THE OBJECT IS ONLY AVAILABLE FOR «IDX ETHERCAT».**

Contains the information to interpret the objects in function areas of the modules.

Name	Modular device profile
Index	0xF000
Object code	RECORD
Highest subindex supported	2

### 6.2.132.1 Index distance

Name	Index distance
Index	0xF000
Subindex	0x01
Data type	UNSIGNED16
Access type	RO
Default value	–
Value range	0x0010 0x0010
PDO mapping	NO
Backup	NO

### 6.2.132.2 Maximum number of modules

Name	Maximum number of modules
Index	0xF000
Subindex	0x02
Data type	UNSIGNED16
Access type	RO
Default value	–
Value range	1 1
PDO mapping	NO
Backup	NO



## 6.2.133 Configured module ident list

**THE OBJECT IS ONLY AVAILABLE FOR «IDX ETHERCAT».**

Contains the identification numbers of the configured modules.

The device supports only one module. If the number of configured modules is set to “0” (zero), no module is active.

Write access is only permitted in ESM state «Pre-Operational».

Name	Configured module ident list
Index	0xF030
Object code	ARRAY
Highest subindex supported	1

### 6.2.133.1 Nbr of configured modules

Name	Nbr of configured modules
Index	0xF030
Subindex	0x00
Data type	UNSIGNED8
Access type	RW
Default value	0
Value range	0 1
PDO mapping	NO
Backup	NO

### 6.2.133.2 Module 1

For details and their definitions on objects specified for the MDP modules →chapter “6.3 Modular Device Profile Module” on page 6-215.

Name	Module 1
Index	0xF030
Subindex	0x01
Data type	UNSIGNED32
Access type	RW
Default value	–
Value range	→Table 6-141
PDO mapping	NO
Backup	NO

Bit 31...28 (Nibble)	Bit 27...24 (Nibble)	Bit 23...8 (Word)	Bit 7...0 (Byte)
(0x7) IDX	Op mode	Application number	Version

Table 6-140 Configured module identification – Bits

Continued on next page.

Value	Description (MDP Profile 742)
0x71xxxxxx	PPM module ident
0x73xxxxxx	PVM module ident
0x78xxxxxx	CSP module ident
0x79xxxxxx	CSV module ident
0x7Axxxxxx	CST module ident

Table 6-141 Configured module identification types

### 6.2.134 Detected module ident list

**THE OBJECT IS ONLY AVAILABLE FOR «IDX ETHERCAT».**

Contains the module identification during power-up or after executing the «Detect Modules Command».

Name	Detected module ident list
Index	0xF050
Object code	ARRAY
Highest subindex supported	1

#### 6.2.134.1 Nbr of detected modules

Name	Nbr of detected modules
Index	0xF050
Subindex	0x00
Data type	UNSIGNED8
Access type	RO
Default value	0
Value range	0 1
PDO mapping	NO
Backup	NO

#### 6.2.134.2 Module 1

Name	Module 1
Index	0xF050
Subindex	0x01
Data type	UNSIGNED32
Access type	RO
Default value	–
Value range	→ Table 6-141
PDO mapping	NO
Backup	NO

### 6.3 Modular Device Profile Module

In the EtherCAT Slave Information (ESI) file, the default PDO mapping for the different operation modes is defined as Modular Device Profile (MDP) module. The module can be used by the EtherCAT master to remap the PDO for the selected mode.

The module outputs are assigned to the Receive PDO1 mapping (1600-xx), the module inputs are assigned to the Transmit PDO1 mapping (1A00-xx).

Related objects: → “Modular device profile” on page 6-212 / → “Configured module ident list” on page 6-213 / → “Detected module ident list” on page 6-214

#### 6.3.1 MDP Module PPM

Mapped object	Object (index-subindex)	Object name
1 <sup>st</sup>	0x6040-00	→ Controlword
2 <sup>nd</sup>	0x607A-00	→ Target position
3 <sup>rd</sup>	0x6083-00	→ Profile acceleration
4 <sup>th</sup>	0x6084-00	→ Profile deceleration
5 <sup>th</sup>	0x6081-00	→ Profile velocity
6 <sup>th</sup>	0x6060-00	→ Modes of operation
7 <sup>th</sup>	0x60FE-01	→ Digital outputs

Table 6-142 MDP module PPM mapping – Default values for RxPDO

Mapped object	Object (index-subindex)	Object name
1 <sup>st</sup>	0x6041-00	→ Statusword
2 <sup>nd</sup>	0x6064-00	→ Position actual value
3 <sup>rd</sup>	0x606C-00	→ Velocity actual value
4 <sup>th</sup>	0x60F4-00	→ Following error actual value
5 <sup>th</sup>	0x6061-00	→ Modes of operation display
6 <sup>th</sup>	0x60FD-00	→ Digital inputs

Table 6-143 MDP module PPM mapping – Default values for TxPDO

### 6.3.2 MDP Module PVM

Mapped object	Object (index-subindex)	Object name
1 <sup>st</sup>	0x6040-00	→Controlword
2 <sup>nd</sup>	0x60FF-00	→Target velocity
3 <sup>rd</sup>	0x6083-00	→Profile acceleration
4 <sup>th</sup>	0x6084-00	→Profile deceleration
5 <sup>th</sup>	0x6060-00	→Modes of operation
6 <sup>th</sup>	0x60FE-01	→Digital outputs

Table 6-144 MDP module PVM mapping – Default values for RxPDO

Mapped object	Object (index-subindex)	Object name
1 <sup>st</sup>	0x6041-00	→Statusword
2 <sup>nd</sup>	0x6064-00	→Position actual value
3 <sup>rd</sup>	0x606C-00	→Velocity actual value
4 <sup>th</sup>	0x6061-00	→Modes of operation display
5 <sup>th</sup>	0x60FD-00	→Digital inputs

Table 6-145 MDP module PVM mapping – Default values for TxPDO

## 6.3.3 MDP Module CSP

Mapped object	Object (index-subindex)	Object name
1 <sup>st</sup>	0x6040-00	→Controlword
2 <sup>nd</sup>	0x607A-00	→Target position
3 <sup>rd</sup>	0x60B0-00	→Position offset
4 <sup>th</sup>	0x60B2-00	→Torque offset
5 <sup>th</sup>	0x6060-00	→Modes of operation
6 <sup>th</sup>	0x60FE-01	→Digital outputs

Table 6-146 MDP module CSP mapping – Default values for RxPDO

Mapped object	Object (index-subindex)	Object name
1 <sup>st</sup>	0x6041-00	→Statusword
2 <sup>nd</sup>	0x6064-00	→Position actual value
3 <sup>rd</sup>	0x606C-00	→Velocity actual value
4 <sup>th</sup>	0x6077-00	→Torque actual value
5 <sup>th</sup>	0x6061-00	→Modes of operation display
6 <sup>th</sup>	0x60FD-00	→Digital inputs

Table 6-147 MDP module CSP mapping – Default values for TxPDO

### 6.3.4 MDP Module CSV

Mapped object	Object (index-subindex)	Object name
1 <sup>st</sup>	0x6040-00	→Controlword
2 <sup>nd</sup>	0x60FF-00	→Target velocity
3 <sup>rd</sup>	0x60B1-00	→Velocity offset
4 <sup>th</sup>	0x6060-00	→Modes of operation
5 <sup>th</sup>	0x60FE-01	→Digital outputs

Table 6-148 MDP module CSV mapping – Default values for RxPDO

Mapped object	Object (index-subindex)	Object name
1 <sup>st</sup>	0x6041-00	→Statusword
2 <sup>nd</sup>	0x6064-00	→Position actual value
3 <sup>rd</sup>	0x606C-00	→Velocity actual value
4 <sup>th</sup>	0x6077-00	→Torque actual value
5 <sup>th</sup>	0x6061-00	→Modes of operation display
6 <sup>th</sup>	0x60FD-00	→Digital inputs

Table 6-149 MDP module CSV mapping – Default values for TxPDO

## 6.3.5 MDP Module CST

Mapped object	Object (index-subindex)	Object name
1 <sup>st</sup>	0x6040-00	→Controlword
2 <sup>nd</sup>	0x6071-00	→Target torque
3 <sup>rd</sup>	0x60B2-00	→Torque offset
4 <sup>th</sup>	0x6060-00	→Modes of operation
5 <sup>th</sup>	0x60FE-01	→Digital outputs

Table 6-150 MDP module CST mapping – Default values for RxPDO

Mapped object	Object (index-subindex)	Object name
1 <sup>st</sup>	0x6041-00	→Statusword
2 <sup>nd</sup>	0x6064-00	→Position actual value
3 <sup>rd</sup>	0x606C-00	→Velocity actual value
4 <sup>th</sup>	0x6077-00	→Torque actual value
5 <sup>th</sup>	0x6061-00	→Modes of operation display
6 <sup>th</sup>	0x60FD-00	→Digital inputs

Table 6-151 MDP module CST mapping – Default values for TxPDO

**••page intentionally left blank••**



## 7 ERROR HANDLING

### 7.1 Emergency Message Frame

Upon detection of device-internal errors, the device will transmit emergency message frames over the CANopen network using →“COB-ID EMCY” on page 6-67. An emergency message frame will be transmitted only once per error event and consists of the error code and the actual state of the →“Error register” on page 6-63.

Byte	0	1	2	3	4	5	6	7
Description	Error code		Error register	Not used (always “0”)				

Table 7-152 Emergency message frame

### 7.2 Device Errors

The device can detect a variety of device errors. The reaction to an error depends on error type and option code. After execution of the fault reaction, the device changes to fault state and the drive will be disabled.

The →“Error history” on page 6-64 holds the error codes that occurred and will be signaled via an emergency message frames. The →“Error register” on page 6-63 holds all set error flags and provides a summary on possible errors.

For fault reaction codes, the following notations will be used:

- a: Use →“Abort connection option code” on page 6-179.
- f: Use →“Fault reaction option code” on page 6-183.
- d: A secure movement is no longer possible.

“Position Clear” points out that the position will be clearing upon executing the error reset.

Error code	Error register	Name	Fault reaction code	Position clear
0x0000	0000 0000b	No Error	–	
0x1000	0000 0001b	→Generic error	d	
0x1080 ... 0x1088	0000 0001b	→Generic initialization error	d	
0x1090	0000 0001b	→Firmware incompatibility error	d	
0x2310	0000 0010b	→Overcurrent error	d	
0x2320	0000 0010b	→Power stage protection error	d	
0x3210	0000 0100b	→Overvoltage error	d	
0x3220	0000 0100b	→Undervoltage error	d	
0x4210	0000 1000b	→Thermal overload error	d	
0x4380	0000 1000b	→Thermal motor overload error	d	
0x5113	0000 0100b	→Logic supply voltage too low error	d	
0x5280	0000 0001b	→Hardware defect error	d	
0x5281	0000 0001b	→Hardware incompatibility error	d	
0x5480 ... 0x5483	0000 0001b	→Hardware error	d	

Continued on next page.

Error code	Error register	Name	Fault reaction code	Position clear
0x6080	0000 0001b	→ Sign of life error	d	
0x6081	0000 0001b	→ Extension 1 watchdog error	a	
0x6180 ... 0x61F0	0000 0001b	→ Internal software error	d	
0x6320	0000 0001b	→ Software parameter error	f	
0x6380	0000 0001b	→ Persistent parameter corrupt error	d	
0x7320	0010 0000b	→ Position sensor error	d	
0x7380	0010 0000b	→ Position sensor breach error	d	X
0x738C	0010 0000b	→ SSI sensor error	d	
0x738D	0010 0000b	→ SSI sensor frame error	d	
0x7390	0010 0000b	→ Missing main sensor error	d	
0x7391	0010 0000b	→ Missing commutation sensor error	d	
0x7392	0010 0000b	→ Main sensor direction error	d	X
0x8110	0001 0000b	→ CAN overrun error (object lost)	a	
0x8111	0001 0000b	→ CAN overrun error	a	
0x8120	0001 0000b	→ CAN passive mode error	a	
0x8130	0001 0000b	→ CAN heartbeat error	a	
0x8150	0001 0000b	→ CAN PDO COB-ID collision	a	
0x8180	0001 0000b	→ EtherCAT communication error	a	
0x8181	0001 0000b	→ EtherCAT initialization error	d	
0x8182	0001 0000b	→ EtherCAT Rx queue overflow	a	
0x8183	0001 0000b	→ EtherCAT communication error (internal)	a	
0x81FD	0001 0000b	→ CAN bus turned off	a	
0x81FE	0001 0000b	→ CAN Rx queue overflow	a	
0x81FF	0001 0000b	→ CAN Tx queue overflow	a	
0x8210	0001 0000b	→ CAN PDO length error	a	
0x8250	0001 0000b	→ RPDO timeout	a	
0x8280	0001 0000b	→ EtherCAT PDO communication error	a	
0x8281	0001 0000b	→ EtherCAT SDO communication error	a	
0x8611	1000 0000b	→ Following error	f	
0x8A80	1000 0000b	→ Negative limit switch error	f	
0x8A81	1000 0000b	→ Positive limit switch error	f	
0x8A82	1000 0000b	→ Software position limit error	f	
0xFF01	0000 0001b	→ System overloaded error	d	
0xFF02	0000 0001b	→ Watchdog error	d	X
0xFF0B	0000 0001b	→ System peak overloaded error	d	
0xFF10	0010 0000b	→ Controller gain error	f	
0xFF12	0010 0000b	→ Auto tuning current limit error	d	
0xFF13	0010 0000b	→ Auto tuning identification current error	d	
0xFF14	0010 0000b	→ Auto tuning data sampling error	d	
0xFF15	0010 0000b	→ Auto tuning sample mismatch error	d	

Continued on next page.

Error code	Error register	Name	Fault reaction code	Position clear
0xFF16	0010 0000b	→Auto tuning parameter error	d	
0xFF17	0010 0000b	→Auto tuning amplitude mismatch error	d	
0xFF18	0010 0000b	→Auto tuning period length error	d	
0xFF19	0010 0000b	→Auto tuning timeout error	d	
0xFF20	0010 0000b	→Auto tuning standstill error	d	
0xFF21	0010 0000b	→Auto tuning torque invalid error	d	
0xFF22	0010 0000b	→Auto tuning max system speed error	d	

Table 7-153 Device error codes

### 7.2.1 Generic error

Error code	0x1000
Error register	0000 0001b
Cause	Unspecific error occurred
Effect	Device disabled Red LED "ON" Error flag set in →Statusword
Error recovery	Reset fault with →Controlword

### 7.2.2 Generic initialization error

Error code	0x1080 thru 0x1083
Error register	0000 0001b
Cause	Critical error occurred during boot-up
Effect	Device disabled Red LED "ON" Error flag set in →Statusword
Error recovery	Reset device. If the problem persists, contact your supplier.

### 7.2.3 Firmware incompatibility error

Error code	0x1090
Error register	0000 0001b
Cause	Incompatible extension firmware version detected
Effect	Device disabled Red LED "ON" Error flag set in →Statusword
Error recovery	First, try to resolve by resetting the device. If reset fails, update the firmware. If the problem persists, contact your supplier.

### 7.2.4 Overcurrent error

Error code	0x2310
Error register	0000 0010b
Cause	<ul style="list-style-type: none"> <li>• Short circuit in motor winding</li> <li>• Controller gains too high and/or deceleration too high</li> <li>• Damaged power stage</li> </ul>
Effect	Device disabled Red LED "ON" Error flag set in → Statusword
Error recovery	Reset fault with → Controlword

### 7.2.5 Power stage protection error

Error code	0x2320
Error register	0000 0010b
Cause	<ul style="list-style-type: none"> <li>• Short circuit of motor winding against ground</li> <li>• Short circuit of motor winding against operating voltage Vcc</li> <li>• Damaged power stage</li> <li>• Strong motor ripple (on top of a high peak current draw)</li> <li>• High deceleration or acceleration demands (which push the control to its limits)</li> <li>• Max. peak current configured which is close to the power stage current protection level</li> <li>• Poor current control parameter set</li> </ul>
Effect	Device disabled Red LED "ON" Error flag set in → Statusword
Error recovery	Reset fault with → Controlword

### 7.2.6 Overvoltage error

Error code	0x3210
Error register	0000 0100b
Cause	Power supply voltage too high
Effect	Device disabled Red LED "ON" Error flag set in → Statusword
Error recovery	In most cases this error occurs at deceleration where the motor works as a generator and the energy flows from motor to power supply (resulting in an increased voltage). Usually, a capacitor (for example 2200 µF) close to the device will solve the problem. If not, a shunt regulator will be necessary to dissipate brake energy. Reset fault with → Controlword (only possible if supply voltage is in valid range).

**7.2.7 Undervoltage error**

Error code	0x3220
Error register	0000 0100b
Cause	<ul style="list-style-type: none"> <li>• Supply voltage is too low for operation</li> <li>• Power supply cannot supply required acceleration current</li> </ul>
Effect	Device disabled Red LED "ON" Error flag set in → Statusword
Error recovery	Reset fault with → Controlword

**7.2.8 Thermal overload error**

Error code	0x4210
Error register	0000 1000b
Cause	Temperature at device's power stage too high
Effect	Device disabled Red LED "ON" Error flag set in → Statusword
Error recovery	Reset fault with → Controlword (only possible if temperature is in valid range)

**7.2.9 Thermal motor overload error**

Error code	0x4380
Error register	0000 1000b
Cause	Temperature at motor too high or sensor not connected
Effect	Device disabled Red LED "ON" Error flag set in → Statusword
Error recovery	Reset fault with → Controlword (only possible if temperature is in valid range)

**7.2.10 Logic supply voltage too low error**

Error code	0x5113
Error register	0000 0100b
Cause	Logic supply voltage is too low for operation
Effect	Device disabled Red LED "ON" Error flag set in → Statusword
Error recovery	Reset fault with → Controlword (only possible if supply voltage is in valid range)

### 7.2.11 Hardware defect error

Error code	0x5280
Error register	0000 1000b
Cause	Hardware problem detected
Effect	Device disabled Red LED "ON" Error flag set in → Statusword
Error recovery	Reset device. If the problem persists, contact your supplier.

### 7.2.12 Hardware incompatibility error

Error code	0x5281
Error register	0000 1000b
Cause	An incompatible hardware combination was detected
Effect	Device disabled Red LED "ON" Error flag set in → Statusword
Error recovery	Reset device. If the problem persists, contact your supplier.

### 7.2.13 Hardware error

Error code	0x5480 thru 0x5483
Error register	0000 0001b
Cause	A hardware problem was detected
Effect	Device disabled Red LED "ON" Error flag set in → Statusword
Error recovery	Reset device. If the problem persists, contact your supplier.

### 7.2.14 Sign of life error

Error code	0x6080
Error register	0000 0001b
Cause	Problem with connection to extension 1: <ul style="list-style-type: none"> <li>• Overload situation</li> <li>• Extension hardware failure</li> </ul>
Effect	Device disabled Red LED "ON" Error flag set in → Statusword
Error recovery	Reset fault with → Controlword Check that extension 1 is firmly connected If problem reoccurs frequently: <ul style="list-style-type: none"> <li>• Update firmware</li> <li>• Contact your supplier</li> </ul>

**7.2.15 Extension 1 watchdog error**

Error code	0x6081
Error register	0000 0001b
Cause	Connection loss to extension 1: <ul style="list-style-type: none"> <li>• Overload situation</li> <li>• Extension hardware failure</li> </ul>
Effect	Device disabled Red LED "ON" Error flag set in → Statusword
Error recovery	Reset fault with → Controlword Check that extension 1 is firmly connected If problem reoccurs frequently: <ul style="list-style-type: none"> <li>• Update firmware</li> <li>• Contact your supplier</li> </ul>

**7.2.16 Internal software error**

Error code	0x6180 thru 0x6190
Error register	0010 0000b
Cause	An internal software error occurred
Effect	Device disabled Red LED "ON" Error flag set in → Statusword
Error recovery	Reset fault with → Controlword

**7.2.17 Software parameter error**

Error code	0x6320
Error register	0010 0000b
Cause	Corrupt parameter detected
Effect	Fault reaction defined in → Fault reaction option code
Error recovery	Reset fault with → Controlword

**7.2.18 Persistent parameter corrupt error**

Error code	0x6380
Error register	0000 0001b
Cause	Persistent parameters are corrupt or inconsistent (wrong CRC)
Effect	Default parameters are set Device disabled Red LED "ON" Error flag set in → Statusword
Error recovery	Reset fault with → Controlword Set or load device parameters again

### 7.2.19 Position sensor error

Error code	0x7320
Error register	0010 0000b
Cause	Detected position of position sensor is no longer valid due to... <ul style="list-style-type: none"> <li>• changed/wrong position sensor parameters</li> <li>• other errors that influence the absolute position detection</li> </ul>
Effect	Device disabled Red LED "ON" Error flag set in → Statusword
Error recovery	Reset fault with → Controlword

### 7.2.20 Position sensor breach error

Error code	0x7380
Error register	0010 0000b
Cause	Position sensor supervision has detected a bad working condition due to... <ul style="list-style-type: none"> <li>• wrong/broken wiring of encoder</li> <li>• defective encoder</li> <li>• regulation parameter are not well tuned (→ Current control parameter set)</li> </ul>
Effect	Device disabled Red LED "ON" Error flag set in → Statusword
Error recovery	Reset fault with → Controlword

### 7.2.21 SSI sensor error

Error code	0x738C
Error register	0010 0000b
Cause	SSI sensor driver could not sample position data
Effect	Device disabled Red LED "ON" Error flag set in → Statusword
Error recovery	Reset fault with → Controlword

### 7.2.22 SSI sensor frame error

Error code	0x738D
Error register	0010 0000b
Cause	Invalid SSI sensor data frame. Start and/or stop bits have invalid state: <ul style="list-style-type: none"> <li>• wrong wiring of SSI sensor</li> <li>• defective SSI sensor</li> <li>• wrong setting of encoder data bits</li> </ul>
Effect	Device disabled Red LED "ON" Error flag set in → Statusword
Error recovery	Reset fault with → Controlword



**7.2.23 Missing main sensor error**

Error code	0x7390
Error register	0010 0000b
Cause	No main sensor available. Adapt settings in →Axis configuration.
Effect	Device disabled Red LED "ON" Error flag set in →Statusword
Error recovery	Reset fault with →Controlword

**7.2.24 Missing commutation sensor error**

Error code	0x7391
Error register	0010 0000b
Cause	No commutation sensor available. Adapt settings in →Axis configuration.
Effect	Device disabled Red LED "ON" Error flag set in →Statusword
Error recovery	Reset fault with →Controlword

**7.2.25 Main sensor direction error**

Error code	0x7392
Error register	0010 0000b
Cause	Position sensor supervision has detected a turn-away of the motor in the opposite direction due to... <ul style="list-style-type: none"> <li>• wrong setting of sensor polarity</li> <li>• wrong position sensor wiring</li> <li>• wrong motor wiring</li> </ul>
Effect	Device disabled Red LED "ON" Error flag set in →Statusword
Error recovery	Reset fault with →Controlword

**7.2.26 CAN overrun error (object lost)**

Error code	0x8110
Error register	0001 0000b
Cause	One of the CAN mail boxes experienced an overflow caused by too high communication rate
Effect	Fault reaction defined in →Abort connection option code
Error recovery	Reset fault with →Controlword

### 7.2.27 CAN overrun error

Error code	0x8111
Error register	0001 0000b
Cause	Execution of CAN communication had an overrun caused by too high communication rate
Effect	Fault reaction defined in →Abort connection option code
Error recovery	Reset fault with →Controlword

### 7.2.28 CAN passive mode error

Error code	0x8120
Error register	0001 0000b
Cause	Device changed to CAN passive mode due to... <ul style="list-style-type: none"> <li>• CAN bit rate of one CAN node in network wrong</li> <li>• CAN network not connected</li> <li>• hardware wiring of CAN bus not correct</li> </ul>
Effect	Fault reaction defined in →Abort connection option code
Error recovery	Send NMT command reset communication

### 7.2.29 CAN heartbeat error

Error code	0x8130
Error register	0001 0000b
Cause	CANopen Heartbeat Consumer Procedure or Life Guarding have detected a timeout. Probably, the procedure has failed due to wrong configuration. Heartbeat Consumers will be disabled if →Consumer heartbeat time = 0.
Effect	Fault reaction defined in →Abort connection option code
Error recovery	Send NMT command reset communication

### 7.2.30 CAN PDO COB-ID collision

Error code	0x8150
Error register	0001 0000b
Cause	Possibly, another CAN node has configured the same transmit PDO COB-ID. Device has received a bad transmit PDO request (valid COB-ID without RTR bit set).
Effect	Fault reaction defined in →Abort connection option code
Error recovery	Reset fault with →Controlword

### 7.2.31 EtherCAT communication error

Error code	0x8180
Error register	0001 0000b
Cause	EtherCAT communication error during operation enable (link lost)
Effect	Fault reaction defined in →Abort connection option code
Error recovery	Reset fault with →Controlword

**7.2.32 EtherCAT initialization error**

Error code	0x8181
Error register	0001 0000b
Cause	Initialization of the Ethernet module has failed
Effect	Device disabled Red LED "ON" Error flag set in →Statusword
Error recovery	Reset device. If the problem persists, perform firmware update or contact your supplier.

**7.2.33 EtherCAT Rx queue overflow**

Error code	0x8182
Error register	0001 0000b
Cause	The EtherCAT receive queue had an overrun caused by too high communication rate
Effect	Fault reaction defined in →Abort connection option code
Error recovery	Reset fault with →Controlword

**7.2.34 EtherCAT communication error (internal)**

Error code	0x8183
Error register	0001 0000b
Cause	Internal communication of the EtherCAT module has failed
Effect	Fault reaction defined in Abort connection option code
Error recovery	Reset fault with →Controlword

**7.2.35 CAN bus turned off**

Error code	0x81FD
Error register	0001 0000b
Cause	CAN controller has entered CAN bus off state
Effect	Fault reaction defined in →Abort connection option code
Error recovery	Reset fault with →Controlword

**7.2.36 CAN Rx queue overflow**

Error code	0x81FE
Error register	0001 0000b
Cause	One of the CAN receive queues had an overrun caused by too high communication rate
Effect	Fault reaction defined in →Abort connection option code
Error recovery	Reset fault with →Controlword

### 7.2.37 CAN Tx queue overflow

Error code	0x81FF
Error register	0001 0000b
Cause	One of the CAN transmit queues had an overrun caused by too high communication rate due to... <ul style="list-style-type: none"> <li>• load on CAN bus too high</li> <li>• event-triggered PDOs defined with too small inhibit time</li> <li>• PDO communication configured too high (synchronous) for actual cycle time</li> <li>• CAN bus inactive but heartbeat producer enabled (→Producer heartbeat time)</li> </ul>
Effect	Fault reaction defined in →Abort connection option code
Error recovery	Reset fault with →Controlword

### 7.2.38 CAN PDO length error

Error code	0x8210
Error register	0001 0000b
Cause	Received PDO was not processed due to length error (too short)
Effect	Fault reaction defined in →Abort connection option code
Error recovery	Reset fault with →Controlword

### 7.2.39 RPDO timeout

Error code	0x8250
Error register	0001 0000b
Cause	<ul style="list-style-type: none"> <li>• Interpolation aborted in cyclic mode due to no PDO received after elapsed interpolation time period</li> <li>• The error also occurs if the master aborts communication, e.g. due to timing violations of the synchronous PDO transfer</li> </ul>
Effect	Fault reaction defined in →Abort connection option code
Error recovery	Reset fault with →Controlword

### 7.2.40 EtherCAT PDO communication error

Error code	0x8280
Error register	0001 0000b
Cause	EtherCAT module detected an error at Process Data (PDO) communication
Effect	Fault reaction defined in →Abort connection option code
Error recovery	Reset fault with →Controlword

### 7.2.41 EtherCAT SDO communication error

Error code	0x8281
Error register	0001 0000b
Cause	EtherCAT module detected an error at Service Data (SDO) communication
Effect	Fault reaction defined in →Abort connection option code
Error recovery	Reset fault with →Controlword

**7.2.42 Following error**

Error code	0x8611
Error register	1000 0000b
Cause	Difference between →Position demand value and →Position actual value higher than →Following error window
Effect	Fault reaction defined in →Fault reaction option code
Error recovery	Reset fault with →Controlword

**7.2.43 Negative limit switch error**

Error code	0x8A80
Error register	1000 0000b
Cause	<ul style="list-style-type: none"> <li>Negative limit switch was/is active</li> <li>Wrong configuration of limit switch function in →Digital inputs</li> </ul>
Effect	Fault reaction defined in →Fault reaction option code
Error recovery	Reset fault with →Controlword

**7.2.44 Positive limit switch error**

Error code	0x8A81
Error register	1000 0000b
Cause	<ul style="list-style-type: none"> <li>Positive limit switch was/is active</li> <li>Wrong configuration of limit switch function in →Digital inputs</li> </ul>
Effect	Fault reaction defined in →Fault reaction option code
Error recovery	Reset fault with →Controlword

**7.2.45 Software position limit error**

Error code	0x8A82
Error register	1000 0000b
Cause	Movement commanded or actual position runs out of software position limit
Effect	Fault reaction defined in →Fault reaction option code
Error recovery	Reset fault with →Controlword

**7.2.46 System overloaded error**

Error code	0xFF01
Error register	0000 0001b
Cause	Device has not enough free resources to process new commands
Effect	Device disabled Red LED "ON" Error flag set in →Statusword
Error recovery	Reset fault with →Controlword

#### 7.2.47 Watchdog error

Error code	0xFF02
Error register	0000 0001b
Cause	Cyclic monitoring has detected an invalid device status
Effect	Device disabled Red LED "ON" Error flag set in → Statusword
Error recovery	Reset fault with → Controlword

#### 7.2.48 System peak overloaded error

Error code	0xFF0B
Error register	0000 0001b
Cause	The device has not enough free resources to provide proper regulation
Effect	Device disabled Red LED "ON" Error flag set in → Statusword
Error recovery	Reset fault with → Controlword

#### 7.2.49 Controller gain error

Error code	0xFF10
Error register	0010 0000b
Cause	Control function not possible due to bad controller gains
Effect	Device disabled Red LED "ON" Error flag set in → Statusword Fault reaction defined in → Fault reaction option code
Error recovery	Reset fault with → Controlword

#### 7.2.50 Auto tuning current limit error

Error code	0xFF12
Error register	0010 0000b
Cause	Current limit occurred during auto tuning identification
Effect	Device disabled Red LED "ON" Error flag set in → Statusword
Error recovery	Reset fault with → Controlword

**7.2.51 Auto tuning identification current error**

Error code	0xFF13
Error register	0010 0000b
Cause	Identification current could not be reached during auto tuning identification
Effect	Device disabled Red LED "ON" Error flag set in → Statusword
Error recovery	Reset fault with → Controlword

**7.2.52 Auto tuning data sampling error**

Error code	0xFF14
Error register	0010 0000b
Cause	Data sampling initialization has failed
Effect	Device disabled Red LED "ON" Error flag set in → Statusword
Error recovery	Reset fault with → Controlword

**7.2.53 Auto tuning sample mismatch error**

Error code	0xFF15
Error register	0010 0000b
Cause	Sample data mismatched during auto tuning identification
Effect	Device disabled Red LED "ON" Error flag set in → Statusword
Error recovery	Reset fault with → Controlword

**7.2.54 Auto tuning parameter error**

Error code	0xFF16
Error register	0010 0000b
Cause	Wrong parameter for auto tuning identification. Error during identification auto tuning process
Effect	Device disabled Red LED "ON" Error flag set in → Statusword
Error recovery	Reset fault with → Controlword

#### 7.2.55 Auto tuning amplitude mismatch error

Error code	0xFF17
Error register	0010 0000b
Cause	Nominal actual amplitude mismatch during auto tuning identification
Effect	Device disabled Red LED "ON" Error flag set in → Statusword
Error recovery	Reset fault with → Controlword

#### 7.2.56 Auto tuning period length error

Error code	0xFF18
Error register	0010 0000b
Cause	Sample period length too long during auto tuning identification
Effect	Device disabled Red LED "ON" Error flag set in → Statusword
Error recovery	Reset fault with → Controlword

#### 7.2.57 Auto tuning timeout error

Error code	0xFF19
Error register	0010 0000b
Cause	Auto tuning identification timeout. Termination requirements not met
Effect	Device disabled Red LED "ON" Error flag set in → Statusword
Error recovery	Reset fault with → Controlword

#### 7.2.58 Auto tuning standstill error

Error code	0xFF20
Error register	0010 0000b
Cause	Motor did not reach standstill during auto tuning. Make sure that the motor is not moving when starting the tuning process.
Effect	Device disabled Red LED "ON" Error flag set in → Statusword
Error recovery	Reset fault with → Controlword



**7.2.59 Auto tuning torque invalid error**

Error code	0xFF21
Error register	0010 0000b
Cause	Motor movement has been obstructed during tuning process. This might, for example, be caused by the motor being connected to a rigid gear. Ensure that the motor movement is not obstructed.
Effect	Device disabled Red LED "ON" Error flag set in → Statusword
Error recovery	Reset fault with → Controlword

**7.2.60 Auto tuning max system speed error**

Error code	0xFF22
Error register	0010 0000b
Cause	Max system speed exceeded during auto tuning identification. Reduce step amplitude to reduce max speed.
Effect	Device disabled Red LED "ON" Error flag set in → Statusword
Error recovery	Reset fault with → Controlword

### 7.3 CANopen Communication Errors (Abort Codes)

An abort object will be sent over the network instead of a response to a SDO request if the request has failed. The same abort code will be sent as part of the response to other transfer request (such as USB).

The following abort codes are defined by CANopen Communication Profile CiA 301. Codes greater 0x0F00 0000 are maxon-specific.

Abort code	Name	Cause
0x0000 0000	No abort	Communication successful
0x0503 0000	Toggle error	Toggle bit not alternated
0x0504 0000	SDO timeout	SDO protocol timed out
0x0504 0001	Command unknown	Command specifier unknown
0x0504 0004	CRC error	CRC check failed
0x0601 0000	Access error	Unsupported access to an object
0x0601 0001	Write only error	Read command to a write only object
0x0601 0002	Read only error	Write command to a read only object
0x0601 0003	Subindex cannot be written	Subindex cannot be written, subindex 0 must be "0" (zero) for write access
0x0602 0000	Object does not exist error	Last read or write command had wrong object index or subindex
0x0604 0041	PDO mapping error	Object is not mappable to the PDO
0x0604 0042	PDO length error	Number and length of objects to be mapped would exceed PDO length
0x0604 0043	General parameter error	General parameter incompatibility
0x0604 0047	General internal incompatibility error	General internal incompatibility in device
0x0606 0000	Hardware error	Access failed due to hardware error
0x0607 0010	Service parameter error	Data type does not match, length or service parameter do not match
0x0607 0013	Service parameter too short error	Data type does not match, length of service parameter too low
0x0609 0011	Subindex error	Last read or write command had wrong object subindex
0x0609 0030	Value range error	Value range of parameter exceeded
0x0800 0000	General error	General error
0x0800 0020	Transfer or store error	Data cannot be transferred or stored
0x0800 0022	Wrong device state error	Data cannot be transferred or stored to application because of present device state
0x0F00 FFBE	Password error	Password is incorrect
0x0F00 FFBF	Illegal command error	Command code is illegal (does not exist)
0x0F00 FFC0	Wrong NMT state error	Device is in wrong NMT state

Table 7-154 CANopen communication errors

## 7.4 EtherCAT FoE Error Codes

In the event of a communication error during a File over EtherCAT (FoE) transfer, the following error codes as defined in the ETG.1020 V1.2.0 EtherCAT Protocol Enhancements Specification (→[12]) will be used.

Error code	Name	Cause
0x8002	Access denied	Unsupported access to an object
0x8004	Illegal	Data cannot be transferred or stored to application due to present device state
0x8008	Bootstrap only	FoE download is supported in bootstrap state only
0x8009	Not bootstrap	The downloaded file is not accepted for firmware updates
0x800B	Program error	Firmware programming was aborted due to a general internal error
0x800C	Checksum wrong	The checksum of the downloaded file was wrong
0x800D	Firmware does not fit for hardware	The firmware file is incompatible to the device hardware
0x8011	Flash problem	The flash memory of the device could not be erased or programmed
0x8012	File incompatible	The firmware format is incompatible to the device

Table 7-155 EtherCAT FoE communication error codes

**••page intentionally left blank••**

## 8 FIRMWARE VERSION HISTORY

### 8.1 Version Overview

Date [yyyy-mm]	Version		Application		Description
	Software	Hardware	#	Version	
2019-11	0160h	6751h	0000h	0000h	Initial release

Table 8-156 Version overview

## 8.2 Version History

IDX_0160h_xxxxh_0000h_0000h (Release 2019-11)		
<b>Binary Files</b>	IDX 56	IDX_0160h_6751h_0000h_0000h.bin
<b>Features</b>	Full range	Initial release

## LIST OF FIGURES

Figure 1-1	Documentation structure . . . . .	7
Figure 2-2	Communication architecture . . . . .	13
Figure 2-3	Device State Machine . . . . .	14
Figure 3-4	Functional architecture . . . . .	19
Figure 3-5	Profile Position Mode – Block diagram . . . . .	21
Figure 3-6	Profile position trajectory . . . . .	22
Figure 3-7	Profile Position Mode – Setpoint example. . . . .	24
Figure 3-8	Profile Velocity Mode – Block diagram . . . . .	25
Figure 3-9	Profile velocity trajectory – Linear ramp (trapezoidal profile) . . . . .	25
Figure 3-10	Homing Mode – Block diagram . . . . .	28
Figure 3-11	Homing trajectory – Linear ramp (trapezoidal profile) . . . . .	28
Figure 3-12	Homing method 17 . . . . .	31
Figure 3-13	Homing method 18 . . . . .	31
Figure 3-14	Homing method 23 . . . . .	32
Figure 3-15	Homing method 27 . . . . .	32
Figure 3-16	Homing method 37 . . . . .	33
Figure 3-17	Homing method -3. . . . .	33
Figure 3-18	Homing method -4. . . . .	33
Figure 3-19	Cyclic Synchronous Position Mode – Overview . . . . .	34
Figure 3-20	Cyclic Synchronous Position Mode – Block diagram . . . . .	35
Figure 3-21	Cyclic Synchronous Velocity Mode – Overview . . . . .	38
Figure 3-22	Cyclic Synchronous Velocity Mode – Block diagram . . . . .	38
Figure 3-23	Cyclic Synchronous Torque Mode – Overview . . . . .	41
Figure 3-24	Cyclic Synchronous Torque Mode – Block diagram . . . . .	41
Figure 3-25	Position Control Function – Block diagram . . . . .	44
Figure 3-26	Velocity Control Function – Block diagram . . . . .	46
Figure 3-27	Current Control Function – Block diagram . . . . .	48
Figure 4-28	Digital input functionality . . . . .	51
Figure 4-29	Digital output functionality . . . . .	52
Figure 4-30	Analog input functionality . . . . .	53
Figure 6-31	SSI encoder – Data rate vs. cable length . . . . .	139
Figure 6-32	SSI encoder – Data frame. . . . .	140
Figure 6-33	SSI encoder – Timing . . . . .	142
Figure 6-34	Block commutation of EC (BLDC) motors – Definition of phases . . . . .	144
Figure 6-35	SSI encoder – Data bits . . . . .	145
Figure 6-36	Standstill window. . . . .	159
Figure 6-37	Holding brake activation timing (digital output polarity “High active”) . . . . .	166
Figure 6-38	Analog input current set value properties – Setpoint function. . . . .	172
Figure 6-39	Analog input current set value properties – Set value. . . . .	172
Figure 6-40	Analog input velocity set value properties – Setpoint function . . . . .	175
Figure 6-41	Analog input velocity set value properties – Set value . . . . .	175

**••page intentionally left blank••**



## LIST OF TABLES

Table 1-1	Notations used . . . . .	8
Table 1-2	Abbreviations & acronyms used . . . . .	8
Table 1-3	Brand names and trademark owners . . . . .	9
Table 1-4	Sources for additional information. . . . .	10
Table 2-5	Device state bits . . . . .	15
Table 2-6	Device state transitions . . . . .	16
Table 2-7	Axis control commands . . . . .	16
Table 2-8	User-defined units – Parameter structure . . . . .	17
Table 2-9	SI units – Notation index . . . . .	17
Table 2-10	CiA 402 Application profile-specific units – Notation index . . . . .	17
Table 2-11	Unit prefixes – Notation index . . . . .	18
Table 3-12	Profile Position Mode – Configuration parameters . . . . .	22
Table 3-13	Profile Position Mode – Commanding parameters . . . . .	23
Table 3-14	Profile Position Mode – Controlword. . . . .	23
Table 3-15	Profile Position Mode – Controlword bits . . . . .	23
Table 3-16	Profile Position Mode – Output parameters . . . . .	23
Table 3-17	Profile Position Mode – Statusword . . . . .	24
Table 3-18	Profile Position Mode – Statusword bits . . . . .	24
Table 3-19	Profile Velocity Mode – Configuration parameters . . . . .	26
Table 3-20	Profile Velocity Mode – Commanding parameters . . . . .	26
Table 3-21	Profile Velocity Mode – Controlword. . . . .	26
Table 3-22	Profile Velocity Mode – Controlword bits. . . . .	26
Table 3-23	Profile Velocity Mode – Output parameters. . . . .	27
Table 3-24	Profile Velocity Mode – Statusword. . . . .	27
Table 3-25	Profile Velocity Mode – Statusword bits . . . . .	27
Table 3-26	Homing Mode – Configuration parameters . . . . .	29
Table 3-27	Homing Mode – Commanding parameters . . . . .	29
Table 3-28	Homing Mode – Controlword. . . . .	29
Table 3-29	Homing Mode – Controlword bits . . . . .	29
Table 3-30	Homing Mode – Output parameters . . . . .	30
Table 3-31	Homing Mode – Statusword . . . . .	30
Table 3-32	Homing Mode – Statusword bit 15 . . . . .	30
Table 3-33	Homing Mode – Statusword bits 10, 12, and 13 . . . . .	30
Table 3-34	Cyclic Synchronous Position Mode – Configuration parameters . . . . .	36
Table 3-35	Cyclic Synchronous Position Mode – Commanding parameters . . . . .	36
Table 3-36	Cyclic Synchronous Position Mode – Output parameters. . . . .	37
Table 3-37	Cyclic Synchronous Position Mode – Statusword. . . . .	37
Table 3-38	Cyclic Synchronous Position Mode – Statusword bits . . . . .	37
Table 3-39	Cyclic Synchronous Velocity Mode – Configuration parameters. . . . .	39
Table 3-40	Cyclic Synchronous Velocity Mode – Commanding parameters. . . . .	39
Table 3-41	Cyclic Synchronous Velocity Mode – Output parameters . . . . .	39

Table 3-42	Cyclic Synchronous Velocity Mode – Statusword	40
Table 3-43	Cyclic Synchronous Velocity Mode – Statusword bits	40
Table 3-44	Cyclic Synchronous Torque Mode – Configuration parameters	42
Table 3-45	Cyclic Synchronous Torque Mode – Commanding parameters	42
Table 3-46	Cyclic Synchronous Torque Mode – Output parameters	42
Table 3-47	Cyclic Synchronous Torque Mode – Statusword	43
Table 3-48	Cyclic Synchronous Torque Mode – Statusword bits	43
Table 3-49	Position Control Function – Configuration parameters	44
Table 3-50	Position Control Function – Output parameters	45
Table 3-51	Velocity Control Function – Configuration parameters	46
Table 3-52	Velocity Control Function – Output Parameters	47
Table 3-53	Current Control Function – Configuration parameters	48
Table 3-54	Current Control Function – Output parameters	49
Table 6-55	Object data types	57
Table 6-56	Object codes	57
Table 6-57	Object access types	57
Table 6-58	Object flags	58
Table 6-59	Object Dictionary (overview)	62
Table 6-60	Error register bits	63
Table 6-61	Store parameters signature	66
Table 6-62	Restore default parameters signature	67
Table 6-63	Consumer heartbeat time – Structure	68
Table 6-64	Definition of hardware version	70
Table 6-65	Newest acknowledged message – Read/Write bits	72
Table 6-66	Flags – Read/Write bits	73
Table 6-67	COB-ID used by RxPDO – Structure	76
Table 6-68	COB-ID used by RxPDO – Description	76
Table 6-69	Receive PDO mapping – Structure of mapped object	81
Table 6-70	Receive PDO 1 mapping	82
Table 6-71	Receive PDO 2 mapping	84
Table 6-72	Receive PDO 3 mapping	86
Table 6-73	Receive PDO 4 mapping	88
Table 6-74	COB-ID used by TxPDO – Structure	89
Table 6-75	COB-ID used by TxPDO – Description	89
Table 6-76	Transmit PDO mapping – Structure of mapped object	97
Table 6-77	Transmit PDO 1 mapping	98
Table 6-78	Transmit PDO 2 mapping	100
Table 6-79	Transmit PDO 3 mapping	102
Table 6-80	Transmit PDO 4 mapping	104
Table 6-81	SYNC mode output parameters	109
Table 6-82	Synchronization types supported – Output parameters	110
Table 6-83	SYNC mode input parameters	113
Table 6-84	Synchronization types supported – Input parameters	114
Table 6-85	Program control – Value range	117

Table 6-86	Program software identification – Value range	118
Table 6-87	Flash status identification – Value range	120
Table 6-88	CAN bit rate	122
Table 6-89	Fieldbus type	123
Table 6-90	Active controller type	124
Table 6-91	Extension 1 hardware – Version definition	125
Table 6-92	Extension communication type	127
Table 6-93	Sensor configuration – Bits	129
Table 6-94	Supported sensor types	129
Table 6-95	Control structure – Bits	130
Table 6-96	Commutation sensors – Bits	131
Table 6-97	Commutation sensors – Value range	131
Table 6-98	Axis configuration miscellaneous – Bits	132
Table 6-99	Max system speed – Limits	133
Table 6-100	Max system speed – Speed limitations based on velocity units	133
Table 6-101	Gear velocity limits	138
Table 6-102	Gear miscellaneous configuration – Bits	138
Table 6-103	SSI encoder – Number of data bits	140
Table 6-104	SSI encoder – Protocol	141
Table 6-105	SSI position bits	145
Table 6-106	Digital input bits	161
Table 6-107	Digital inputs – Default values	162
Table 6-108	Digital inputs – Configuration	163
Table 6-109	Digital output bits	164
Table 6-110	Digital outputs – Default values	165
Table 6-111	Digital outputs – Configuration	165
Table 6-112	Holding brake states	167
Table 6-113	Analog inputs – Default values	169
Table 6-114	Analog inputs – Configuration	169
Table 6-115	Abort connection option code	179
Table 6-116	Controlword bits	180
Table 6-117	Statusword bits	182
Table 6-118	Quick stop option code	182
Table 6-119	Shutdown option code	182
Table 6-120	Disable operation option code	183
Table 6-121	Fault reaction option code	183
Table 6-122	Modes of operation	184
Table 6-123	Motion profile types	194
Table 6-124	Homing methods	194
Table 6-125	SI units position – Bits	196
Table 6-126	SI units position – Value range	196
Table 6-127	SI units velocity – Bits	197
Table 6-128	SI units velocity – Value range	197
Table 6-129	SI units acceleration – Bits	198

Table 6-130	SI units acceleration – Value range	198
Table 6-131	Touch probe function	200
Table 6-132	Touch probe status	201
Table 6-133	Touch probe 1 source	205
Table 6-134	Touch probe 1 positive edge counter	206
Table 6-135	Touch probe 1 negative edge counter	206
Table 6-136	Digital inputs	208
Table 6-137	Digital outputs	209
Table 6-138	Motor types	210
Table 6-139	Supported drive modes – Bits	211
Table 6-140	Configured module identification – Bits	213
Table 6-141	Configured module identification types	214
Table 6-142	MDP module PPM mapping – Default values for RxPDO	215
Table 6-143	MDP module PPM mapping – Default values for TxPDO	215
Table 6-144	MDP module PVM mapping – Default values for RxPDO	216
Table 6-145	MDP module PVM mapping – Default values for TxPDO	216
Table 6-146	MDP module CSP mapping – Default values for RxPDO	217
Table 6-147	MDP module CSP mapping – Default values for TxPDO	217
Table 6-148	MDP module CSV mapping – Default values for RxPDO	218
Table 6-149	MDP module CSV mapping – Default values for TxPDO	218
Table 6-150	MDP module CST mapping – Default values for RxPDO	219
Table 6-151	MDP module CST mapping – Default values for TxPDO	219
Table 7-152	Emergency message frame	221
Table 7-153	Device error codes	223
Table 7-154	CANopen communication errors	238
Table 7-155	EtherCAT FoE communication error codes	239
Table 8-156	Version overview	241

## INDEX

### Numerics

- 1st assigned RxPDO (object) 107
- 1st assigned TxPDO (object) 108
- 1st mapped object in RxPDO 1 (object) 82
- 1st mapped object in RxPDO 2 (object) 84
- 1st mapped object in RxPDO 3 (object) 86
- 1st mapped object in RxPDO 4 (object) 88
- 1st mapped object in TxPDO 1 (object) 98
- 1st mapped object in TxPDO 2 (object) 100
- 1st mapped object in TxPDO 3 (object) 102
- 1st mapped object in TxPDO 4 (object) 104

### A

- abbreviations & acronyms 8
- abort codes 238
- Abort connection option code (object) 179
- Access denied (error code) 239
- Access error (abort code) 238
- access types 57
- Active controller type (object) 124
- Active fieldbus (object) 123
- Additional identity (object) 124
- Analog input 1...2 adjustment offset (object) 171
- Analog input 1...2 configuration (object) 169
- Analog input 1...2 voltage (object) 168
- Analog input adjustment (object) 171
- Analog input current set value properties (object) 172
- analog input functionality 53
- Analog input general purpose (object) 170
- Analog input general purpose A...B (object) 170
- Analog input properties (object) 168
- Analog input velocity set value properties (object) 175
- applicable EU directive 11
- Auto tuning amplitude mismatch error (error message) 236
- Auto tuning current limit error (error message) 234
- Auto tuning data sampling error (error message) 235
- Auto tuning identification current error (error message) 235
- Auto tuning max system speed error (error message) 237
- Auto tuning parameter error (error message) 235
- Auto tuning period length error (error message) 236
- Auto tuning sample mismatch error (error message) 235
- Auto tuning standstill error (error message) 236
- Auto tuning timeout error (error message) 236
- Auto tuning torque invalid error (error message) 237
- Axis configuration (object) 129
- Axis configuration miscellaneous (object) 132

### B

- binary files 241
- bit rate
  - CAN 122
- Bootstrap only (error code) 239

### C

- Calc and copy time (object) 111, 115
- CAN bit rate (object) 122
- CAN bit rate display (object) 123
- CAN bus turned off (error message) 231
- CAN heartbeat error (error message) 230
- CAN overrun error (error message) 230
- CAN overrun error (object lost) (error message) 229
- CAN passive mode error (error message) 230
- CAN PDO COB-ID collision (error message) 230
- CAN PDO length error (error message) 232
- CAN Rx queue overflow (error message) 231
- CAN Tx queue overflow (error message) 232
- CANopen communication errors 238
- Checksum wrong (error code) 239
- COB-ID EMCY (object) 67
- COB-ID SDO client to server (object) 75
- COB-ID SDO server to client (object) 75
- COB-ID SYNC (object) 65
- COB-ID used by RxPDO 1 (object) 76
- COB-ID used by RxPDO 2 (object) 78
- COB-ID used by RxPDO 3 (object) 79
- COB-ID used by RxPDO 4 (object) 80
- COB-ID used by TxPDO 1 (object) 89
- COB-ID used by TxPDO 2 (object) 91
- COB-ID used by TxPDO 3 (object) 93
- COB-ID used by TxPDO 4 (object) 95
- Command unknown (abort code) 238
- communication 55
- Communication type SYNC channel 0 (object) 105
- Communication type SYNC channel 1 (object) 105
- Communication type SYNC channel 2 (object) 106
- Communication type SYNC channel 3 (object) 106
- Commutation sensors (object) 131
- Configuration of analog inputs (object) 169
- Configuration of digital inputs (object) 162
- Configuration of digital outputs (object) 165
- Configured module ident list (object) 213
- Consumer 1...2 heartbeat time (object) 68
- Consumer heartbeat time (object) 68
- Control structure (object) 130
- Controller gain error (error message) 234
- Controlword (object) 180
- CRC error (abort code) 238

CST (Cyclic Synchronous Torque Mode) 41  
 CSV (Cyclic Synchronous Velocity Mode) 38  
 current (units) 17  
 Current actual value (object) 156  
 Current actual value averaged (object) 156  
 Current actual values (object) 156  
 Current control parameter set (object) 147  
 Current controller I gain (object) 147  
 Current controller P gain (object) 147  
 Current demand value (object) 155  
 Current set value first current (object) 173  
 Current set value first voltage (object) 173  
 Current set value second current (object) 174  
 Current set value second voltage (object) 173  
 Current threshold for homing mode (object) 155  
 Custom persistent memory (object) 127  
 Custom persistent memory 1...4 (object) 127  
 Cycle time (object) 109, 113  
 Cycle time too small (object) 112, 115  
 Cyclic Synchronous Position Mode (brief description) 20  
 Cyclic Synchronous Torque Mode (brief description) 20  
 Cyclic Synchronous Velocity Mode (brief description) 20

## D

Delay time (object) 111  
 Detected module ident list (object) 214  
 Device type (object) 63  
 Diagnosis History (object) 71  
 Diagnosis message 1...5 (object) 74  
 Digital input 1...4 configuration (object) 162  
 digital input functionality 51  
 Digital input properties (object) 161  
 Digital inputs (object) 208  
 Digital inputs logic state (object) 161  
 Digital inputs polarity (object) 161  
 Digital output 1...2 configuration (object) 165  
 digital output functionality 52  
 Digital output properties (object) 164  
 Digital outputs (object) 209  
 Digital outputs logic state (object) 164  
 Digital outputs polarity (object) 164  
 dimensionless (units) 17  
 Disable operation option code (object) 183

## E

electric current (units) 17  
 Electrical inductance (object) 136  
 Electrical resistance (object) 136  
 Electrical system parameters (object) 136  
 Error code (object) 179  
 Error history (object) 64  
 Error history 1...5 (object) 64  
 Error register (object) 63  
 errors

communication 238  
 device 221  
 EtherCAT communication error (internal) (error message) 231  
 EtherCAT communication error (error message) 230  
 EtherCAT error codes 239  
 EtherCAT initialization error (error message) 231  
 EtherCAT PDO communication error (error message) 232  
 EtherCAT Rx queue overflow (error message) 231  
 EtherCAT SDO communication error (error message) 232  
 EU directive, applicable 11  
 Extension 1 application number (object) 126  
 Extension 1 application version (object) 126  
 Extension 1 hardware version (object) 125  
 Extension 1 identity (object) 125  
 Extension 1 serial number (object) 126  
 Extension 1 software version (object) 125  
 Extension 1 type (object) 127  
 Extension 1 watchdog error (error message) 227

## F

Fault reaction option code (object) 183  
 File incompatible (error code) 239  
 Firmware does not fit for hardware (error code) 239  
 Firmware incompatibility error (error message) 223  
 firmware versions 241  
 flags 58  
 Flags (object) 73  
 Flash problem (error code) 239  
 Flash status identification (object) 119  
 Following error (error message) 233  
 Following error actual value (object) 207  
 Following error timeout (object) 186  
 Following error window (object) 185

## G

gateway communication 55  
 Gear configuration (object) 137  
 Gear miscellaneous configuration (object) 138  
 Gear reduction denominator (object) 137  
 Gear reduction numerator (object) 137  
 General error (abort code) 238  
 General internal incompatibility error (abort code) 238  
 General parameter error (abort code) 238  
 Generic error (error message) 223  
 Generic initialization error (error message) 223

## H

hardware binary files 241  
 Hardware defect error (error message) 226  
 Hardware error (abort code) 238  
 Hardware error (error message) 226  
 Hardware incompatibility error (error message) 226  
 hardware versions 70  
 HMM (Homing Mode) 28

Holding brake fall time (object) 167  
 Holding brake parameters (object) 166  
 Holding brake rise time (object) 167  
 Holding brake state (object) 167  
 Home offset move distance (object) 154  
 Home position (object) 154  
 Homing 28  
 Homing acceleration (object) 196  
 Homing method (object) 194  
 Homing Mode (brief description) 20  
 Homing speeds (object) 195  
 how to  
   decode abbreviations and acronyms 8  
   interpret icons and signs used in the document 9  
   use Current Control Function 48  
   use Cyclic Synchronous Torque Mode 36, 42  
   use Cyclic Synchronous Velocity Mode 39  
   use Homing Mode 29  
   use Position Control Function 44  
   use Profile Position Mode 22  
   use Profile Velocity Mode 26  
   use Velocity Control Function 46

## I

I2t level controller (object) 177  
 Identity object (object) 69  
 Illegal (error code) 239  
 Illegal command error (abort code) 238  
 increments (units) 17  
 Index distance (object) 212  
 Inhibit time TxPDO 1 (object) 90  
 Inhibit time TxPDO 2 (object) 92  
 Inhibit time TxPDO 3 (object) 94  
 Inhibit time TxPDO 4 (object) 96  
 input functionality 51, 53  
 Internal software error (error message) 227  
 Interpolation time index (object) 204  
 Interpolation time period (object) 203  
 Interpolation time period value (object) 203

## L

length (units) 17  
 Logic supply voltage too low error (error message) 225

## M

Main sensor direction error (error message) 229  
 Main sensor resolution (object) 132  
 Manufacturer device name (object) 65  
 mass (units) 17  
 Max acceleration (object) 204  
 Max gear input speed (object) 138  
 Max motor speed (object) 192  
 Max position limit (object) 191  
 Max position range limit (object) 189  
 Max profile velocity (object) 191

Max system speed (object) 133  
 Maximum messages (object) 71  
 Maximum number of modules (object) 212  
 Min position limit (object) 190  
 Min position range limit (object) 189  
 Minimum cycle time (object) 110, 114  
 Missing commutation sensor error (error message) 229  
 Missing main sensor error (error message) 229  
 Modes of operation (object) 184  
 Modes of operation display (object) 184  
 modes, supported 20  
 Modular device profile (object) 212  
 Module 1, configured (object) 213  
 Module 1, detected (object) 214  
 Motion profile type (object) 194  
 Motor data (object) 134  
 Motor protection (object) 177  
 Motor rated torque (object) 187  
 Motor type (object) 210

## N

Nbr of configured modules (object) 213  
 Nbr of detected modules (object) 214  
 Negative limit switch error (error message) 233  
 New messages available (object) 72  
 Newest acknowledged message (object) 72  
 Newest message (object) 71  
 No abort (abort code) 238  
 Node-ID (object) 121  
 Nominal current (object) 134  
 Not bootstrap (error code) 239  
 Number of assigned RxPDOs (object) 107  
 Number of assigned TxPDOs (object) 108  
 Number of errors (object) 64  
 Number of mapped objects in RxPDO 1 (object) 81  
 Number of mapped objects in RxPDO 2 (object) 83  
 Number of mapped objects in RxPDO 3 (object) 85  
 Number of mapped objects in RxPDO 4 (object) 87  
 Number of mapped objects in TxPDO 1 (object) 97  
 Number of mapped objects in TxPDO 2 (object) 99  
 Number of mapped objects in TxPDO 3 (object) 101  
 Number of mapped objects in TxPDO 4 (object) 103  
 Number of pole pairs (object) 135  
 Number of used SYNC manager channels (object) 105

## O

object codes 57  
 Object does not exist error (abort code) 238  
 object lost (see "CAN overrun error")  
 object overview 59  
 operating license 11  
 Output current limit (object) 134  
 output functionality 52  
 Overcurrent error (error message) 224



overview (objects) 59

Overvoltage error (error message) 224

## P

Password error (abort code) 238

PDO length error (abort code) 238

PDO mapping error (abort code) 238

Persistent parameter corrupt error (error message) 227

Physical outputs (object) 209

Position actual value (object) 185

Position control parameter set (object) 148

Position controller D gain (object) 149

Position controller FF acceleration gain (object) 149

Position controller FF velocity gain (object) 149

Position controller I gain (object) 148

Position controller P gain (object) 148

Position demand value (object) 185

Position offset (object) 198

Position range limit (object) 189

Position sensor breach error (error message) 228

Position sensor error (error message) 228

Positive limit switch error (error message) 233

Power stage protection error (error message) 224

Power supply (object) 128

Power supply voltage (object) 128

PPM (Profile Position Mode) 21

prerequisites prior installation 11

Producer heartbeat time (object) 69

Product code (object) 70

Profile acceleration (object) 193

Profile deceleration (object) 193

Profile Position Mode (brief description) 20

Profile velocity (object) 192

Profile Velocity Mode (brief description) 20

Program control (object) 117

Program data (object) 116

Program error (error code) 239

Program number 1 (object)

Flash status identification 119

Program control 117

Program data 116

Program software identification 118

Program software identification (object) 118

purpose of this document 7

PVM (Profile Velocity Mode) 25

## Q

Quick stop deceleration (object) 193

Quick stop option code (object) 182

## R

Read only error (abort code) 238

Receive PDO 1 mapping (object) 81

Receive PDO 1 parameter (object) 76

Receive PDO 2 mapping (object) 83

Receive PDO 2 parameter (object) 78

Receive PDO 3 mapping (object) 85

Receive PDO 3 parameter (object) 79

Receive PDO 4 mapping (object) 87

Receive PDO 4 parameter (object) 80

reference point (see "Homing")

Restore all default parameters (object) 67

Restore default parameters (object) 67

Revision number (object) 70

revolutions (units) 17

RPDO timeout (error message) 232

## S

Save all parameters (object) 66

SDO server parameter (object) 75

SDO timeout (abort code) 238

sensor types 129

Sensors configuration (object) 129

Serial number (object) 70

Serial number complete (object) 124

Service parameter error (abort code) 238

Service parameter too short error (abort code) 238

Shutdown option code (object) 182

SI unit acceleration (object) 198

SI unit position (object) 196

SI unit velocity (object) 197

Sign of life error (error message) 226

signs used 9

SM-event missed (object) 111, 115

Software parameter error (error message) 227

Software position limit (object) 190

Software position limit error (error message) 233

Speed for switch search (object) 195

Speed for zero search (object) 195

SSI absolute encoder (object) 139

SSI commutation offset value (object) 144

SSI data rate (object) 139

SSI encoding type (object) 141

SSI number of data bits (object) 140

SSI position bits (object) 145

SSI position raw value (object) 143

SSI position raw value complete (object) 146

SSI power up time (object) 143

SSI refresh frequency (object) 143

SSI sensor error (error message) 228

SSI sensor frame error (error message) 228

SSI special bits leading data (object) 146

SSI special bits trailing data (object) 142

SSI timeout time (object) 142

Standstill window (object) 160

Standstill window configuration (object) 159

Standstill window time (object) 160

Standstill window timeout (object) 160

Statusword (object) 181



steps (units) 17  
 Store parameters (object) 66  
 Subindex cannot be written (abort code) 238  
 Subindex error (abort code) 238  
 Supported drive modes (object) 211  
 supported modes 20  
 symbols used 9  
 SYNC manager 2 parameter (object) 109  
 SYNC manager 2 PDO assignment (object) 107  
 SYNC manager 3 parameter (object) 113  
 SYNC manager 3 PDO assignment (object) 108  
 SYNC manager communication type (object) 105  
 Synchronization type (object) 109, 113  
 Synchronization types supported, input (object) 114  
 Synchronization types supported, output (object) 110  
 System overloaded error (error message) 233  
 System peak overloaded error (error message) 234

## T

Target position (object) 188  
 Target torque (object) 187  
 Target velocity (object) 210  
 Temperature motor (object) 178  
 Temperature power stage (object) 178  
 Thermal controller protection (object) 178  
 Thermal motor overload error (error message) 225  
 Thermal overload error (error message) 225  
 Thermal time constant winding (object) 135  
 time (units) 17  
 Toggle error (abort code) 238  
 Torque actual value (object) 187  
 Torque actual value averaged (object) 157  
 Torque actual values (object) 157  
 Torque constant (object) 135  
 Torque offset (object) 199  
 Touch probe 1 negative edge counter (object) 206  
 Touch probe 1 positive edge counter (object) 206  
 Touch probe 1 source (object) 205  
 Touch probe function (object) 200  
 Touch probe position 1 negative value (object) 202  
 Touch probe position 1 positive value (object) 201  
 Touch probe source (object) 205  
 Touch probe status (object) 201  
 trajectory generator
 

- Homing 28
- Profile Position 22
- Profile Velocity 25

 Transfer or store error (abort code) 238  
 Transmission type RxPDO 1 (object) 77  
 Transmission type RxPDO 2 (object) 78  
 Transmission type RxPDO 3 (object) 79  
 Transmission type RxPDO 4 (object) 80  
 Transmission type TxPDO 1 (object) 90  
 Transmission type TxPDO 2 (object) 91  
 Transmission type TxPDO 3 (object) 93

Transmission type TxPDO 4 (object) 95  
 Transmit PDO 1 mapping (object) 97  
 Transmit PDO 1 parameter (object) 89  
 Transmit PDO 2 mapping (object) 99  
 Transmit PDO 2 parameter (object) 91  
 Transmit PDO 3 mapping (object) 101  
 Transmit PDO 3 parameter (object) 93  
 Transmit PDO 4 mapping (object) 103  
 Transmit PDO 4 parameter (object) 95

## U

Undervoltage error (error message) 225  
 units (definition of) 17  
 USB frame timeout (object) 122  
 USB-to-CAN gateway 55

## V

Value range error (abort code) 238  
 Velocity actual value (object) 186  
 Velocity actual value averaged (object) 158  
 Velocity actual values (object) 158  
 Velocity control parameter set (object) 150  
 Velocity controller FF acceleration gain (object) 151  
 Velocity controller FF velocity gain (object) 151  
 Velocity controller I gain (object) 150  
 Velocity controller P gain (object) 150  
 Velocity demand value (object) 186  
 Velocity observer friction (object) 153  
 Velocity observer inertia (object) 153  
 Velocity observer load correction gain (object) 153  
 Velocity observer parameter set (object) 152  
 Velocity observer position correction gain (object) 152  
 Velocity observer velocity correction gain (object) 152  
 Velocity offset (object) 199  
 Velocity set value first velocity (object) 176  
 Velocity set value first voltage (object) 176  
 Velocity set value second velocity (object) 177  
 Velocity set value second voltage (object) 176  
 Vendor ID (object) 69  
 version history 241

## W

Watchdog error (error message) 234  
 Write only error (abort code) 238  
 Wrong device state error (abort code) 238  
 Wrong NMT state error (abort code) 238

## Z

zero point (see "Homing")



EtherCAT® is a registered trademark and patented technology, licensed by Beckhoff Automation GmbH, Germany

This document is protected by copyright. Any further use (including reproduction, translation, microfilming, and other means of electronic data processing) without prior written approval is not permitted. The mentioned trademarks belong to their respective owners and are protected under intellectual property rights.

© 2019 maxon. All rights reserved. Subject to change without prior notice.

CCMC | IDX Firmware Specification | Edition 2019-11 | DocID rel9237

maxon motor ag  
Brünigstrasse 220  
CH-6072 Sachseln

+41 41 666 15 00  
[www.maxongroup.com](http://www.maxongroup.com)