

maxon motor

driven by precision



Revision 03

date of creation: 08/14/2016, printing date: 2/1/2018

Contents

1.	Safety note	3
2.	Oil filling	4
2.1	Tools.....	4
2.2	Consumables.....	4
2.3	Refill steps	5
3.	Propeller, Nozzle and shaft seal change	13
3.1	Tools.....	13
3.2	Consumables.....	13
3.3	Propeller change.....	14
3.4	Change nozzle.....	16
3.5	Change shaft seal.....	18

1. Safety note

When using the listed lubricants and adhesives, be sure to follow the safety instructions found on the MSDS (material safety data sheet). Request the latest data sheet from the manufacturer and annually check if it's up-to-date. Follow proper storage time and storage requirements as instructed by manufacturer. Safety goggles and protective gloves must to be worn during the whole oil change process.

2. Oil filling

If the oil dipstick falls below the recommended minimum distance of 3 notches, the total unit must be refilled with oil. The necessary steps are listed below.

2.1 Tools

Order code	Supplier	Comment
598575	maxon motor GmbH	Maintenance kit: 1x hand pump with silicone hose 1x back pressure valve 2x hose clamp

2.2 Consumables

Manufacturer	Designation
Panolin Loctite	HLP SYNTH 15 431

2.3 Refill steps

pictures

working steps

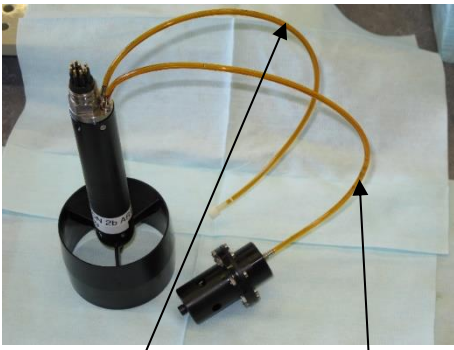

hose 4

hose 5





hose 4

hose 5

Step 1:

Clamp hose 4 just before the plug with a hose clamp. The gap between clamp hose and plug should be about 4 cm.

Equipment:
hose clamp

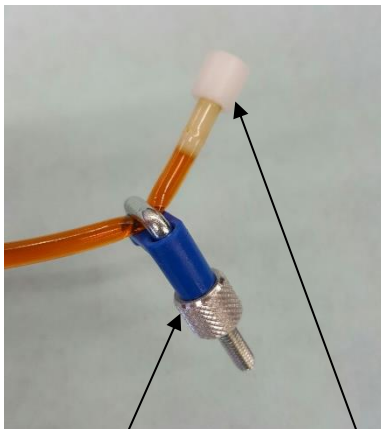

hose clamp

plug

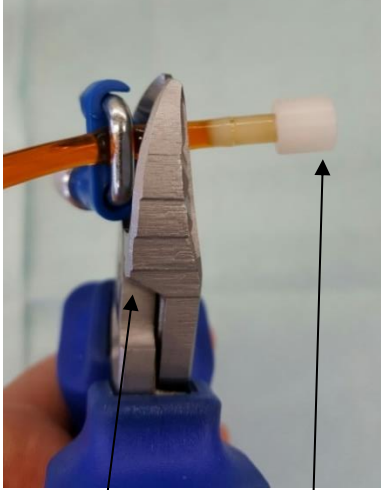

side cutter

plug

Step 2:

Cut hose 4 just between the plug and the hose clamp with a side cutter. The hose length behind the clamp should be a minimum of 2 cm.

Avoid air pockets inside the hose!

Equipment:
side cutter

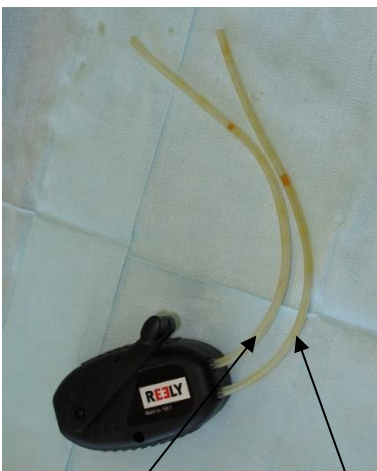

hose 2

hose 1

Step 3:

Cut the provided silicone hose in three equal size pieces. These hoses will be referred to as hose 1, hose 2 and hose 3.

Connect hose 1 and hose 2 to the hand pump, as shown in the picture.

Equipment:
hand pump

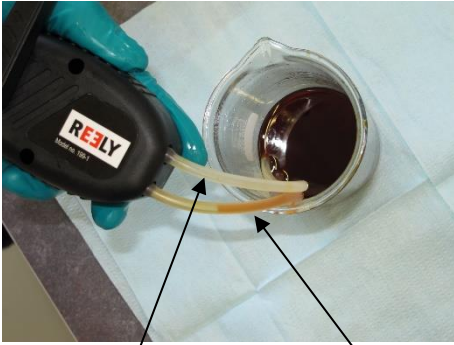

hose 2

hose 1

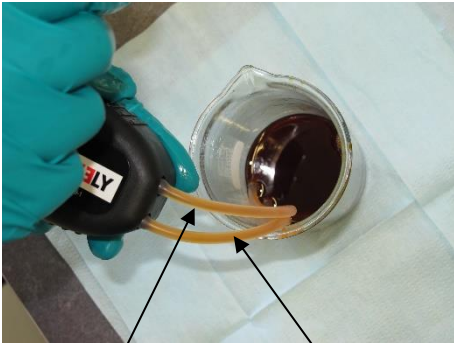

hose 2

hose 1



Hose 2

hose 1

Step 4:

Immerse the open ends of hose 1 and hose 2 in oil and actuate the crank of the hand pump clockwise. Actuate the hand pump until both hoses are completely filled with oil.

Avoid air pockets inside the hose!

Equipment:
hand pump

hose 3

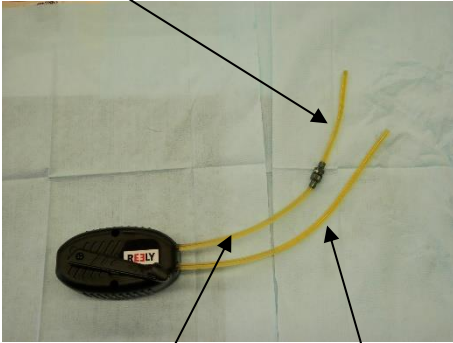

hose 2

hose 1

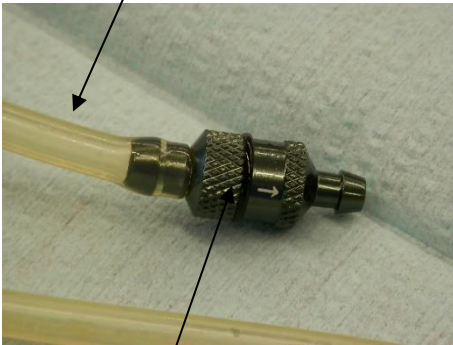

pressure valve

Step 5:

Connect the open end of hose 2 with the back pressure valve. Connect the other end of the back pressure valve with hose 3.

Be sure to note the correct direction of flow indicated on the back pressure valve!

Equipment:

back pressure valve

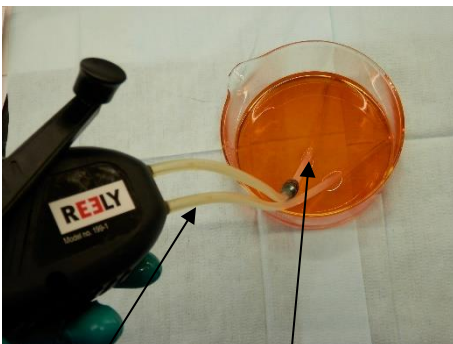

hose 1

hose 3

Step 6:

Immerse the open ends of hose 1 and hose 3 in oil and actuate the crank of the hand pump clockwise. Actuate the hand pump until all three hoses are completely filled with oil.

Avoid air pockets inside the hose!

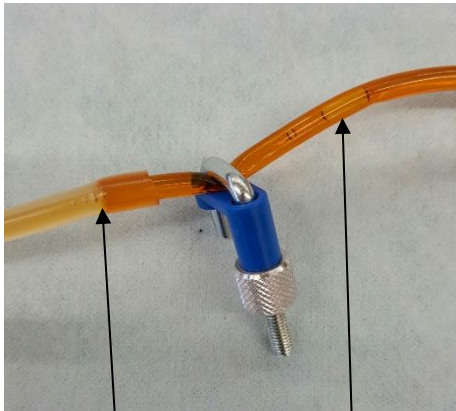

hose 3

hose 4

Step 7:

Connect hose 3 with the clamped end of hose 4. Make sure that both hoses are pushed far enough into each other that slipping off is no longer possible.

Avoid air pockets inside the hose!

Equipment:

Hose clamp

**Step 8:**

In case of air inside hose 1, immerse the end of hose 1 in oil; then squeeze the hose by hand to force this air back out, and then release to suck oil back in.

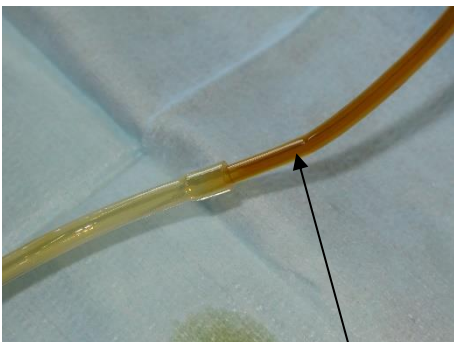

hose 4

Step 9:

Immerse the open end of hose 1 in oil, maintain the connection between hose 3 and hose 4 and remove the hose clamp from hose 4.

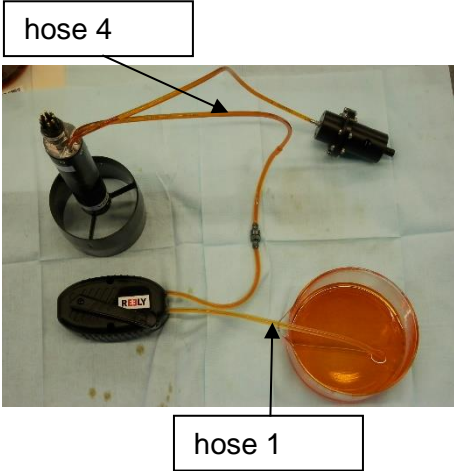

Step 10:

Actuate the hand pump clockwise until the oil dipstick has reached the fill level of the delivery condition. If you are not sure about the fill level for your application please feel free to ask maxon motor.

Equipment:
hand pump

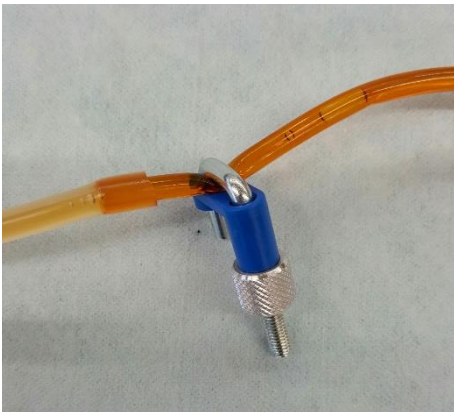

Step 11:

Once the oil dipstick reaches the required fill level clamp hose 4 again with the hose clamp.

Equipment:
hose clamp

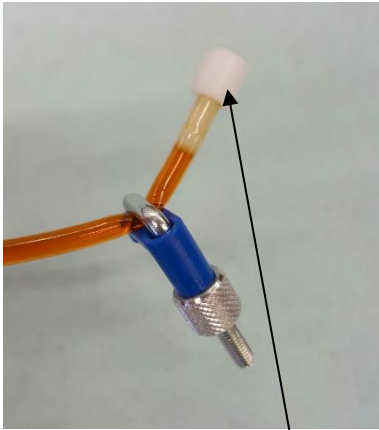

Hose plug

Step 12:

Disconnect hose 3 from hose 4 and replugin the previously removed plug to the open end of hose 4. Remove hose clamp from hose 4.

Avoid air pockets inside the hose!

Equipment:

hose clamp

hose plug

**Step 13:**

Now the required fill level on the compensator is reached.

3. Propeller, Nozzle and shaft seal change

The following chapter describes the procedure for changing the nozzle, propeller and shaft seal.

3.1 Tools

Tool	Comment
torque wrench and socket for female screws with external hexagon	wrench width 8 for the socket torque = 2,0 Nm
torque wrench and blade for screws with hexalobular socket	blade size 10 hexalobular torque = 0,5 Nm

3.2 Consumables

Manufacturer	Designation
Loctite	243
Loctite	E 3508

3.3 Propeller change

If you need to change the propeller, the following work steps must be carried out additionally:

pictures

Change propeller
working steps

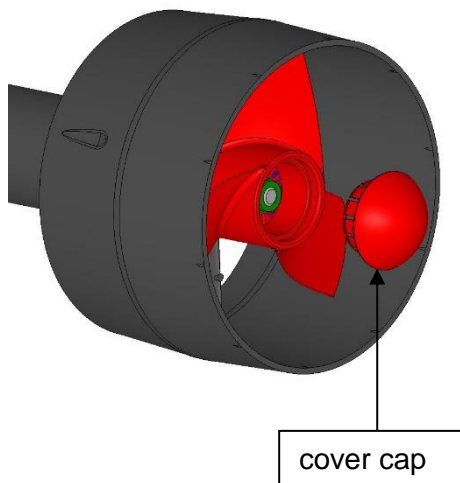

Step 1:

Use a plier to destructively remove the covering cap of the propeller. The propeller could be damaged during the process.

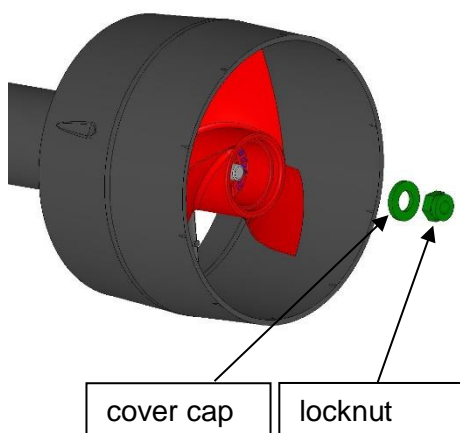

Step 2:

Unscrew the locknut and remove the washer from the output shaft.

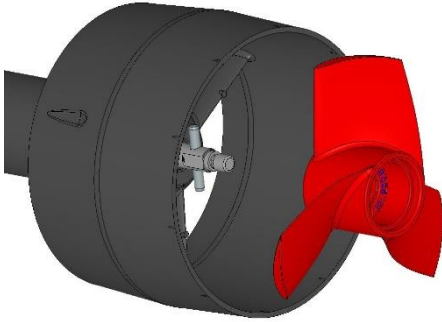
**Step 3:**

Remove the propeller from the output shaft. Now a new propeller can be attached. Follow the previous steps in reverse order.

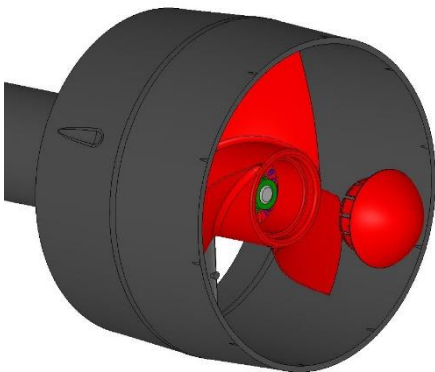
**Step 4:**

Clean all adhesive surfaces with ethanol. Apply Loctite 431 all the way around the front end of the propeller. Affix the cover cap to the propeller. Apply light pressure to the cap for 10 minutes while the adhesive hardens.

3.4 Change nozzle

If you need to change the nozzle, the following work steps must be carried out additionally:

pictures

**Change nozzle
working steps**

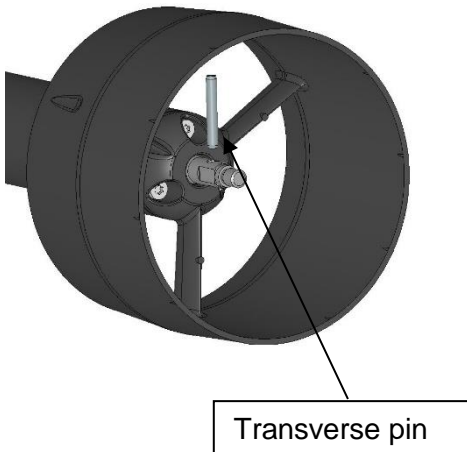

Step 1:

Remove the transverse pin from the output shaft

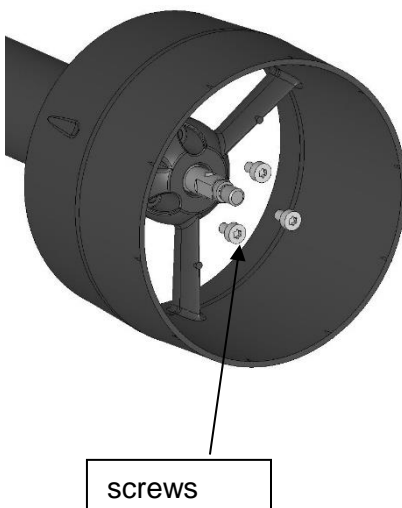

Step 2:

Remove the screws in the nozzle from the flange.

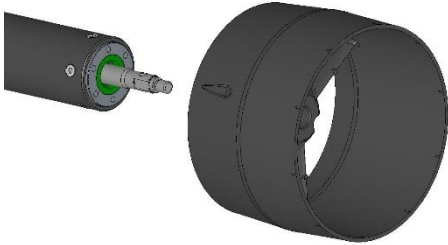
**Step 3:**

The nozzle can now be removed from the drive unit.

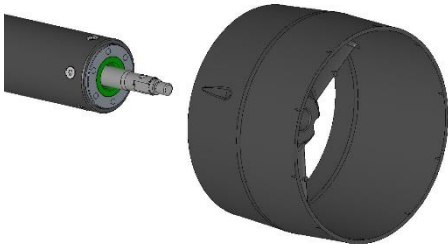
**Step 4:**

Replace the nozzle. Perform steps 1 and 2 in reverse order to attach the new nozzle.

Note that the star (Torx) screws have to be mounted with a torque of 0.5 Nm and the locking nut with a torque of 2.0 Nm. Subsequently, all screw connections have to be secured with Loctite 243 according to manufacturer's instructions.

Equipment:

Torque wrench with the socket for the nuts.

Torque wrench for the Torx screws.

Loctite 243

3.5 Change shaft seal

If you need to change the shaft seal, the following work steps must be carried out additionally:

pictures

Change shaft seal

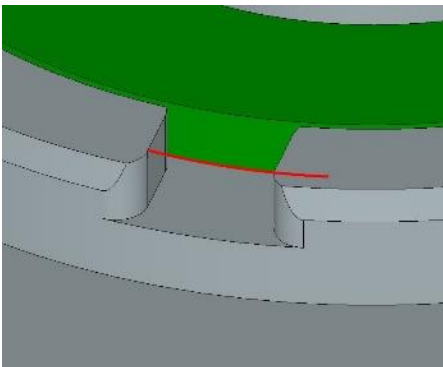
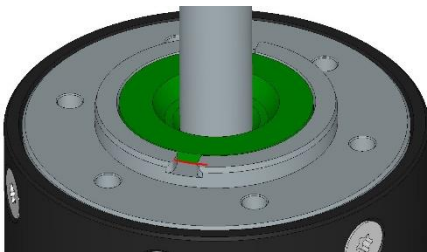

Step 1:

Place a flat-head screwdriver into the two grooves of the flange against the shaft seal. Hit the flat-head screwdriver with a hammer into the shaft seal. Avoid any damage to the flange and the output shaft! In particular, make sure that you do not damage the red edge on the flange and are far enough away with the screwdriver!

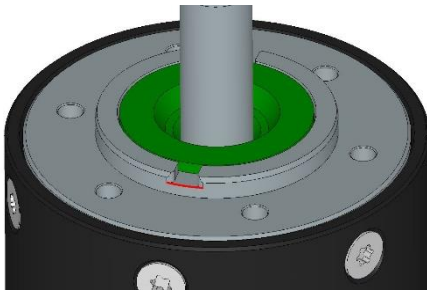

Step 2:

Use the screwdrivers to lever the shaft seal over the red-marked edge on the flange



**Step 3:**

Lubricate the new shaft seal by coating the outside cylinder surface and the inside sealing lip with oil. Slide the shaft seal onto the output shaft as far as the heel.

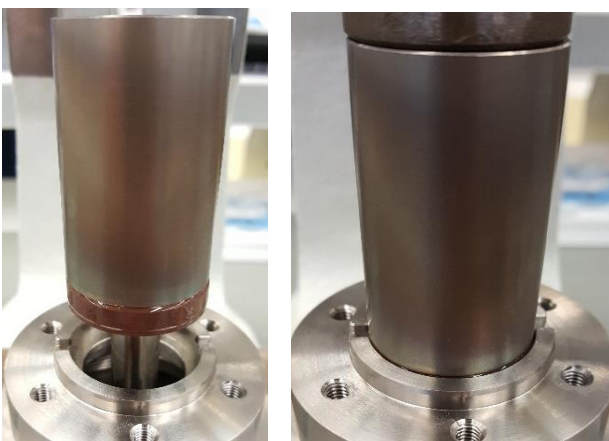
**Step 4:**

Place a sleeve on the shaft seal, which rests flat and has approximately the outer diameter of the shaft seal. Press the new shaft seal into the flange until it rests axially on the flange.