

Formulae Handbook

maxon academy

The image is a complex collage representing technical knowledge. On the left, there are snippets of code, likely from a robot simulator, such as:

```

    modifier_obj = ...
    object to mirror
    mod.mirror_object
    on == "MIRROR X":
    mod.use_x = True
    mod.use_y = False
    mod.use_z = False
    action == "MIRROR Y":
    mod.use_x = False
    mod.use_y = True
    mod.use_z = False
    action == "MIRROR Z":
    mod.use_x = False
    mod.use_y = False
    mod.use_z = True
  
```

On the right, several mathematical formulas are displayed, including:

- $k_n > k_{n,theor} = \frac{n_{o,theor}}{U_{mot}} = \frac{n_{max} + \frac{\Delta n}{\Delta M} \cdot M_{max}}{U_{mot}}$
- $\alpha_{max} = \frac{M_H}{J_R + J_L}$
- $I_{mot} = I_0 + \frac{\pi \cdot M_{max}}{30 \cdot k_M \cdot L}$
- $M_{RMS} = \sqrt{\frac{1}{t_{tot}} (t_1 \cdot M_1^2 + t_2 \cdot M_2^2 + \dots + t_n \cdot M_n^2)}$
- $\Delta t = \frac{\pi}{30} \cdot n_L \cdot \frac{J_R + J_L}{M} = \frac{\pi}{30} \cdot n_L \cdot \frac{J_R + J_L}{k_M \cdot I_{mot}}$
- $n_{o,theor} = \frac{M_H}{U_{mot}}$
- $n_{max} = \left(1 - \frac{I_0}{I_A}\right)^2$
- $k_n > k_{n,theor} = \frac{n_{o,theor}}{U_{mot}} = \frac{n_{max} + \frac{\Delta n}{\Delta M} \cdot M_{max}}{U_{mot}}$

Other elements include a silhouette of a person's head and shoulders, binary code (0s and 1s), and various mathematical symbols and constants like π , α , I , M , J , k , L , n , t , U , M_H , M_{max} , M_{RMS} , n_L , n_{max} , I_0 , I_A , J_R , J_L , k_M , t_{tot} , t_1 , t_2 , t_n , M_1 , M_2 , M_n , M_N , M_H , M_{max} , M_{RMS} , $n_{o,theor}$, n_{max} , I_{mot} , I_0 , I_A , J_R , J_L , k_M , t_{tot} , t_1 , t_2 , t_n , M_1 , M_2 , M_n , M_N , M_H , M_{max} , M_{RMS} , n_L , n_{max} , I_{mot} , I_0 , I_A , J_R , J_L , k_M .

Selection process

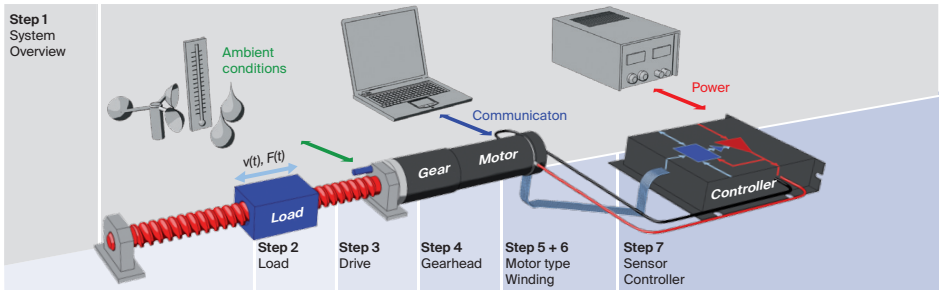

When performing a **system analysis**, the first step is to describe the drive as a whole in its environment. The objective is to obtain an **overview** of the system, to determine the theoretical feasibility of a solution and to get a picture of the boundary conditions and restrictions. **See Chap. A.1: Overview, system analysis**

The goal of "The goal of the Motion of the load" is to define the key requirements regarding forces (torques) and velocities (speeds of rotation). How long must they be applied? What is the required control accuracy? **See Chap. A.2: Motion of the load**

The mechanical drive design can be skipped if the load is driven directly and the drive system does not include a **mechanical drive**.

Mechanical drives transform mechanical power into mechanical power. For the selection of the drive the load key data are converted to the output of the motor or gearshaft. **See Chap. 3 Mechanical drives.**

The step for the **gearhead selection** can be skipped if no (maxon) gearhead is used. Gearheads are typically used whenever high torques are required at low speeds.

The purpose of this step is to determine if and which **maxon gearhead** can be used. The key data for the motor selection can then be calculated from the gearhead reduction and efficiency. **See Chap. 3.4: maxon gearhead**

On the basis of the torque and speed requirements, the next step is to select suitable **types of motors**. The useful life, commutation and bearing systems also have to be considered. **See Chap. 3.4: Motor selection**

The **selection of the winding** is made on the basis of a comparison of the applied motor voltage with the speed and a comparison of the available current with the torque requirements. **See Chap. 6.5: Motor selection**

The purpose of the last step is the **verification of the controller and sensor**, as well as a verification that the controller and sensor preselected in the situation analysis (Step 1) are compatible with the selected motor. **See Chap. A.3: Verification of controller and sensor**

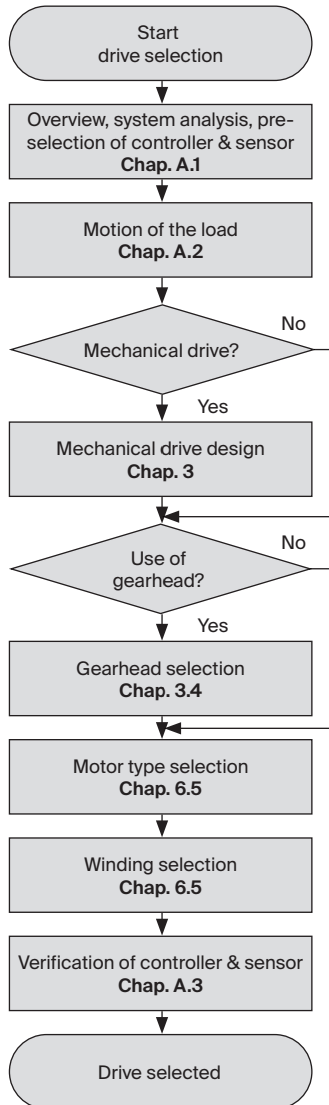

Foreword

This Formulae Handbook lists the most important formulae in relation to all components of the drive system. It makes use of a flow chart that supports quick selection of the correct drive. Numerous illustrations and the clear descriptions of the symbols on the respective page help the reader to understand the formulae.

Roughly speaking, it is a collection of the most important formulae from the maxon catalog, as well as from the book "The selection of high-precision microdrives", published by maxon academy.

The initiative for writing this Formulae Handbook was the book "The selection of high-precision microdrives" by Dr. Urs Kafader, which contains extensive know-how from the success story of 50-years of maxon DC drives with low power (below approx. 500 W). The collection is intended for engineers, professors, lecturers and students, as a perfect supplement to the above mentioned book.

Thank you

Firstly I would like to thank Dr. Urs Kafader, who encouraged me to tackle this book. The professional layout and illustrations were done by Patricia Gabriel and Beni Anderhalden. Urs Kafader, Barbara Schlup, Anja Schütz, Patrik Gnos, Stefan Baumann, Martin Rüegg, Michael Baumgartner, Martin Windlin, Jens Schulze, Albert Bucheli, Martin Odermatt and Walter Schmid have read the manuscript and have given valuable suggestions for improvements. I also received extensive and ready support from many other people at maxon motor ag in response to my questions and requests for assistance.

Special thanks go to Susan Bechtiger, Paul Williams, Robin Philips, Anthony Mayr and Mark Casey who helped improve the translation from German into English.

*Sachseln, Spring 2012
Jan Braun*

5th Edition 2019
© 2019, maxon academy, Sachseln

This work is protected by copyright. All rights reserved, including but not limited to the rights to translation into foreign languages, reproduction, storage on electronic media, reprinting and public presentation. The use of proprietary names, common names etc. in this work does not mean that these names are not protected within the meaning of trademark law. All the information in this work, including but not limited to numerical data, applications, quantitative data etc. as well as advice and recommendations, has been carefully researched, although the accuracy of such information and the total absence of typographical errors cannot be guaranteed. The accuracy of the information provided must be verified by the user in each individual case. The author, the publisher and/or their agents may not be held liable for bodily injury or pecuniary or property damage.



Content

A.	Drive selection	6
A.1	Overview, system analysis	6
A.2	Motion of the load	7
A.3	Verification of controller and sensor	8
1.	Mass, force, torque	9
1.1	Forces in general	9
1.2	Torques in general	11
1.3	Moments of inertia of various bodies with reference to the principal axes through the center of gravity S	12
2.	Kinematics	14
2.1	Linear equations of motion	14
2.2	Rotary equations of motion	15
2.3	Typical linear motion profiles	16
2.4	Typical rotary motion profiles	18
3.	Mechanical drives	21
3.1	Mechanical transmission	21
3.2	Mechanical drives, rotation → linear	22
3.3	Mechanical drives, rotation → rotation	25
3.4	maxon gear	26
4.	Bearing	27
4.1	Comparison of characteristics of sintered sleeve bearings and ball bearings	27
5.	Electrical principles	29
5.1	Principles of DC (Direct Current)	29
5.2	Electrical resistive circuits	31
5.3	Principles of AC (Alternating Current)	33
5.4	Simple filters	34
6.	maxon motors	35
6.1	General	35
6.2	Power consideration DC motor	38
6.3	Motor constants and diagrams	39
6.4	Acceleration	41
6.5	Motor selection	42
7.	maxon sensor	43
8.	maxon controller	45
8.1	Operating quadrants	45
8.2	Selection of power supply	45
8.3	Size of the motor choke with PWM controllers	46
9.	Thermal behavior	47
9.1	Basics	47
9.2	Continuous operation	49
9.3	Cyclic and intermittent operation (continuously repeated)	51
9.4	Short-term operation	52
10.	Tables	53
10.1	maxon Conversion Tables	53
10.2	Typical coefficients of friction for rolling, static and kinetic friction	54
11.	Symbol list for the Formulae Handbook	56

A. Drive selection

A.1 Overview, system analysis

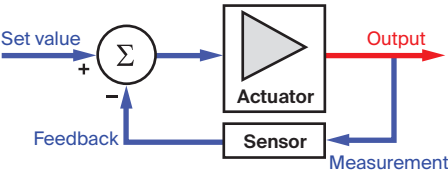
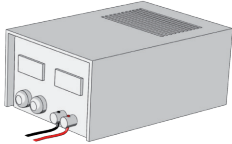
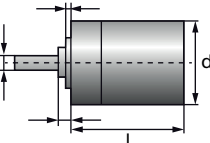
Before the actual selection process begins, a consideration with the drive system in its entirety is needed. The possible range of variations of the key parameters must also be determined. As a rule, all of these aspects are closely interlinked. The descriptions below are intended to help clarify these points and establish a framework for the further selection process.

<p>Mechanical design</p> 	<p>Is the intended motion linear or a rotary? What drive (screw, toothed belt, etc.) or what combination of drives are going to be used to achieve the desired motion? Is it a direct drive?</p>
<p>Define the control concept</p> 	<p>What variables are to be controlled: current, speed, position? With what accuracy? Is an open-loop control system sufficient? How is the controlled variable measured? Where do the commands and set values come from? The answers to these questions will result in a preselection of possible controllers and sensors, i.e. for selection step 7 (see page 2).</p>
<p>Verify the power components</p> 	<p>Is sufficient electric power available to drive the load under all operating conditions and to compensate for the expected losses in the drive train? What are the maximum voltage and current that will be available?</p>
<p>Determine the boundary conditions</p> 	<p>Are there restrictions on size? In what environment (temperature, atmosphere etc.) is the drive required to operate? Is compliance with particular specifications or quality standards required? What is the specified useful life?</p>
<p>Cost considerations</p> 	<p>Cost is always a key consideration. How can the drive be designed as economically as possible and still meet the requirements regarding performance and useful life?</p>

For detailed information, refer to the book "The selection of high-precision microdrives", chapter 3.

A.2 Motion of the load

In the step for determining the **load requirements**, the motions to be executed must be defined. It is important to select appropriate motion profiles and to consider which operating times are to be expected.

Operating points

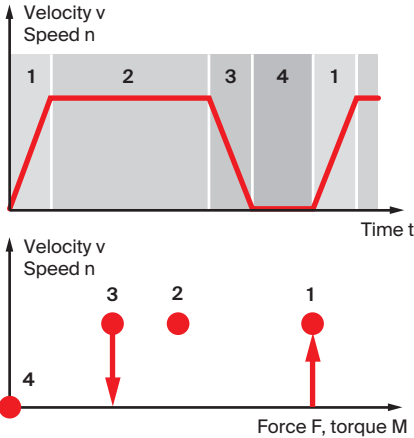

For determining the associated **operating points** (value pairs of torque and speed of rotation or of force and velocity), the respective total forces and torques are important. To this end, all acting forces and torques have to be determined. These in turn depend on the moments of inertia and the acceleration values. For the purpose of making a selection, calculating these values with an accuracy of approx. 10% is sufficient.

Mechanical play of the drive

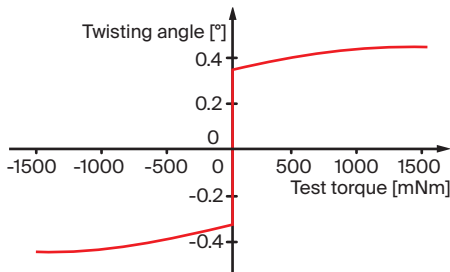

Furthermore, the question of the maximum permissible **mechanical play of the drive** has to be determined.

Key data

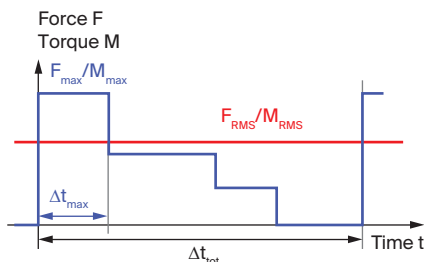

The **key data** which characterize the load can finally be calculated from the operating points. They are important for selecting the drive.

For detailed information, refer to the book "The selection of high-precision microdrives", chapter 4.

A.3 Verification of controller and sensor

The **controller and sensor** verification involves checking whether the preselection made during the system analysis (selection step 1, see page 2) are compatible with the motor chosen. Detailed examination of the configuration of the control circuit allows to make definitive decisions regarding the suitable components (controller and sensor).

Motion controller

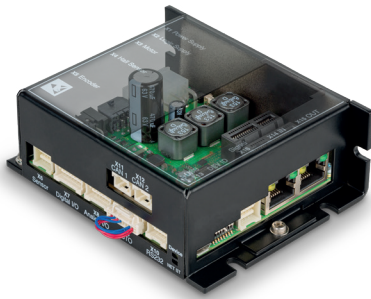

In higher-level drive systems, the motion controller is the central element. It is where all the threads come together. Thus, the controller must satisfy a wide range of requirements.

The controller must

- be able to control the manipulated variable with sufficient accuracy in a reasonable amount of time
- be able to process the information provided by the sensor
- understand the set values and commands of the higher-level system
- provide the required electric power
- be suited to the motor type (brushed or brushless) and the commutation

Sensor

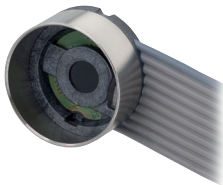

The sensor (encoder, DC tacho or resolver) must be appropriate for the control task and comply with the other components. Additionally, the following further selection criteria apply.

The sensor has to

- be mountable on the motor according to the maxon modular system.
- measure the correct control variable (speed, position, direction of rotation) with sufficient resolution. Rule of thumb: The resolution of the sensor should be at least four times higher than the specified accuracy of the control variable.



For detailed information, refer to the book "The selection of high-precision microdrives", chapter 9.

1. Mass, force, torque

1.1 Forces in general

The force required to accelerate a mass of 1 kg by 1 m/s in 1 s has the unit $\text{kg} \cdot \text{m/s}^2$, with the special unit name Newton (N).

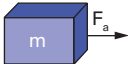
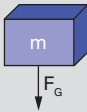
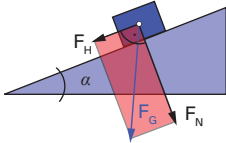
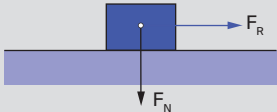
Typical component forces in a drive system

	Force for acceleration = mass · acceleration [F] = $\text{kg} \cdot \text{m/s}^2 = \text{kgm/s}^2 = \text{N}$	$F_a = m \cdot a = m \cdot \frac{\Delta v}{\Delta t}$
	Gravitation (gravitational acceleration $g = 9.81 \text{ m/s}^2 = 9.81 \text{ N/kg} \approx 10 \text{ N/kg}$)	$F_G = m \cdot g$
	Forces on the inclined plane: Downhill-slope force and normal force	$F_H = F_G \cdot \sin \alpha$ $F_N = F_G \cdot \cos \alpha$
	Friction force Sliding friction	$F_R = \mu \cdot F_N$
	Spring force, compression and extension springs	$F_S = k \cdot \Delta l$
	Compressive force	$F_p = p \cdot A$

Symbol	Name	SI	Symbol	Name	SI
A	Cross section	m^2	a	Acceleration	m/s^2
F	Force	N	g	Gravitational acceleration	m/s^2
F_a	Acceleration force	N	k	Spring constant	N/m
F_G	Weight of a body	N	m	Mass	kg
F_H	Downhill-slope force	N	p	Pressure (1 Pa = 1 N/m ² = 10 ⁻⁵ bar)	Pa
F_N	Normal force (force perpendicular to the plane)	N	α	Angle of the inclined plane	°
F_p	Compressive force	N	Δl	Displacement	m
F_R	Friction force	N	Δt	Duration	s
F_S	Spring force	N	Δv	Velocity change	m/s
		N	μ	Coefficient of friction (see table Chap. 10.2)	

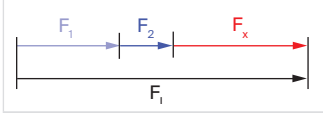
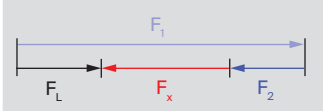
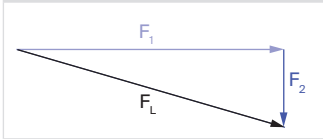

Calculating the total load force consisting of component forces

	<p>Addition of forces acting in the same direction</p>	$F_L = F_1 + F_2 + \dots + F_x$
	<p>Addition of forces acting in opposite directions</p>	$F_L = F_1 - F_2 - \dots - F_x$
	<p>Addition of perpendicular forces</p>	$F_L = \sqrt{F_1^2 + F_2^2}$

Symbol	Name	SI
F_L	Load force (output)	N
$F_1 / F_2 / F_x$	Partial forces	N

1.2 Torques in general

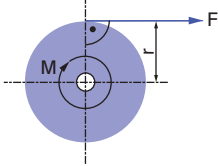
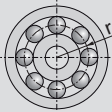
The torque is a measure of the rotational effect that a force exerts on a rotating system. It plays the same role for rotation that the force plays for linear motion. The equations always apply for a defined axis of rotation.

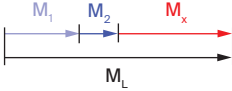
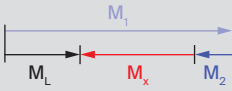
General					
		Torque = force · lever arm $[M] = \text{N} \cdot \text{m} = \text{Nm}$		$M = F \cdot r$	
Typical component torques in drive systems					
Torque for acceleration of moments of inertia Torque = moment of inertia · angular acceleration (For information on calculating moments of inertia, see the next pages)				$M_a = J \cdot \alpha = J \cdot \frac{\Delta\omega}{\Delta t}$ $M_a = J \cdot \frac{\pi}{30} \cdot \frac{\Delta n}{\Delta t}$	
		Friction of ball bearing and sintered sleeve bearing (simplified)		$M_R = \mu \cdot F_{KL} \cdot r_{KL}$	
		Torque of spiral or leg springs		$M_S = k_m \cdot \Delta\varphi$	
Calculating the load torque consisting of component torques					
		Addition of torques acting in same direction		$M_L = M_1 + M_2 + \dots + M_x$	
		Addition of torques acting in opposite directions		$M_L = M_1 - M_2 - \dots - M_x$	
Symbol	Name	SI	Symbol	Name	SI
F	Force	N	r	Radius	m
F_{KL}	Bearing load, axial / radial	N	r_{KL}	Mean radius bearing	m
J	Moment of inertia	kgm ²	α	Angular acceleration	rad/s ²
M	Torque	Nm	Δt	Duration	s
M_L	Load torque	Nm	$\Delta\varphi$	Rotation angle change	rad
M_R	Friction torque	Nm	$\Delta\omega$	Angular velocity change	rad/s
M_S	Torque, spiral spring	Nm	μ	Coefficient of friction (see table chapt. 10.2)	
M_a	Torque for acceleration	Nm			
$M_1/M_2/M_x$	Partial torques	Nm	Symbol	Name	maxon
k_m	Torsion coefficient (spring constant)	Nm	Δn	Speed change	rpm

1.3 Moments of inertia of various bodies with reference to the principal axes through the center of gravity S

Body type	Illustration	Mass, moments of inertia
Circular cylinder, disc		$m = \rho \cdot \pi \cdot r^2 \cdot h$ $J_x = \frac{1}{2} \cdot m \cdot r^2$ $J_y = J_z = \frac{1}{12} \cdot m \cdot (3r^2 + h^2)$
Hollow cylinder		$m = \rho \cdot \pi \cdot (r_a^2 - r_i^2) \cdot h$ $J_x = \frac{1}{2} \cdot m \cdot (r_a^2 + r_i^2)$ $J_y = J_z = \frac{1}{4} \cdot m \cdot \left(r_a^2 + r_i^2 + \frac{h^2}{3} \right)$
Circular cone		$m = \frac{1}{3} \cdot \rho \cdot \pi \cdot r^2 \cdot h$ $J_x = \frac{3}{10} \cdot m \cdot r^2$ $J_y = J_z = \frac{3}{80} \cdot m \cdot (4r^2 + h^2)$
Truncated circular cone		$m = \frac{1}{3} \cdot \rho \cdot \pi \cdot (r_2^2 + r_2 r_1 + r_1^2) \cdot h$ $J_x = \frac{3}{10} \cdot m \cdot \frac{r_2^5 - r_1^5}{r_2^3 - r_1^3}$
Circular torus		$m = 2\rho \cdot \pi^2 \cdot r^2 \cdot R$ $J_x = J_y = \frac{1}{8} \cdot m \cdot (4R^2 + 5r^2)$ $J_z = \frac{1}{4} \cdot m \cdot (4R^2 + 3r^2)$
Sphere		$m = \frac{4}{3} \cdot \rho \cdot \pi \cdot r^3$ $J_x = J_y = J_z = \frac{2}{5} \cdot m \cdot r^2$

Symbol	Name	SI	Symbol	Name	SI
J_x	Moment of inertia with reference to the rotation axis x	kgm ²	h	Height	m
J_y	Moment of inertia with reference to the rotation axis y	kgm ²	m	Mass	kg
J_z	Moment of inertia with reference to the rotation axis z	kgm ²	r	Radius	m
R	Radius circular torus around z-axis	m	r_a	Outer radius	m
			r_i	Inner radius	m
			r_1	Radius 1	m
			r_2	Radius 2	m
			ρ	Density	kg/m ³

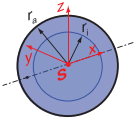
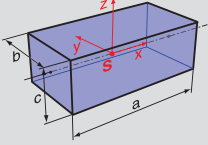
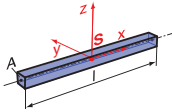
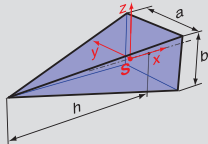
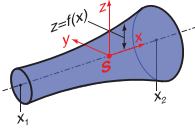
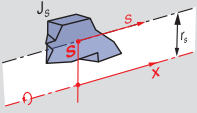
Body type	Illustration	Mass, moments of inertia
Hollow sphere		$m = \frac{4}{3} \cdot \rho \cdot \pi \cdot (r_a^3 - r_i^3)$ $J_x = J_y = J_z = \frac{2}{5} \cdot m \cdot \frac{r_a^5 - r_i^5}{r_a^3 - r_i^3}$
Cuboid		$m = \rho \cdot a \cdot b \cdot c$ $J_x = \frac{1}{12} \cdot m \cdot (b^2 + c^2)$
Thin rod		$m = \rho \cdot A \cdot l$ $J_y = J_z = \frac{1}{12} \cdot m \cdot l^2$
Square pyramid		$m = \frac{1}{3} \cdot \rho \cdot a \cdot b \cdot h$ $J_x = \frac{1}{20} \cdot m \cdot (a^2 + b^2)$ $J_y = \frac{1}{20} \cdot m \cdot (b^2 + \frac{3}{4}h^2)$
Arbitrary rotation body		$m = \rho \cdot \pi \cdot \int_{x_1}^{x_2} f^2(x) \cdot dx$ $J_x = \frac{1}{2} \cdot \rho \cdot \pi \cdot \int_{x_1}^{x_2} f^4(x) \cdot dx$
Steiner's theorem Moment of inertia with reference to a parallel axis of rotation x at a distance of r_s to axis s through the center of gravity S.		$J_x = m \cdot r_s^2 + J_s$

Symbol	Name	SI	Symbol	Name	SI
A	Cross section	m ²	c	Length of side c	m
J _s	Moment of inertia with reference to axis s through center of gravity S	kgm ²	h	Height	m
J _x	Moment of inertia with reference to the rotation axis x	kgm ²	l	Length	m
J _y	Moment of inertia with reference to the rotation axis y	kgm ²	m	Mass	kg
J _z	Moment of inertia with reference to the rotation axis z	kgm ²	r _a	Outer radius	m
a	Length of side a	m	r _i	Inner radius	m
b	Length of side b	m	r _s	Distance of axis s from center of gravity S	m
			ρ	Density	kg/m ³
			x ₁	Point 1 on the x-axis	m
			x ₂	Point 2 on the x-axis	m

2. Kinematics

2.1 Linear equations of motion

Uniform movement

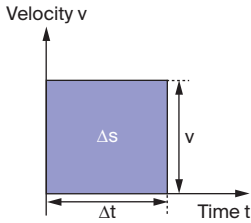

Velocity
 $v = \Delta s / \Delta t = \text{constant}$
 $[v] = \text{m/s}$

$$v = \frac{\Delta s}{\Delta t}$$

$$\Delta s = v \cdot \Delta t$$

Constant acceleration from a standing start

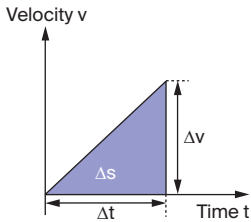

Acceleration
 $a = \Delta v / \Delta t = \text{constant}$
 $[a] = \text{m/s}^2$

$$\Delta v = a \cdot \Delta t$$

$$\Delta s = \frac{1}{2} \cdot a \cdot \Delta t^2$$

Free fall

$$\Delta v = g \cdot \Delta t$$

$$h = \frac{1}{2} \cdot g \cdot \Delta t^2$$

Constant acceleration from initial speed

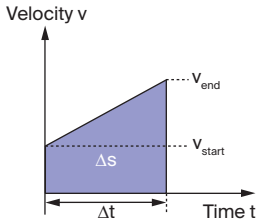

$$v_{\text{end}} = v_{\text{start}} + a \cdot \Delta t$$

$$\Delta s = v_{\text{start}} \cdot \Delta t + \frac{1}{2} a \cdot \Delta t^2$$

Symbol	Name	SI	Symbol	Name	SI
a	Acceleration	m/s^2	$t, \Delta t$	Time, duration	s
g	Gravitational acceleration	m/s^2	$v, \Delta v$	Velocity, velocity change	m/s
h	Drop height	m	v_{end}	Velocity after acceleration	m/s
Δs	Distance change	m	v_{start}	Velocity before acceleration	m/s

Remark:

- The shaded areas represent the distance Δs traveled during time period Δt .

2.2 Rotary equations of motion

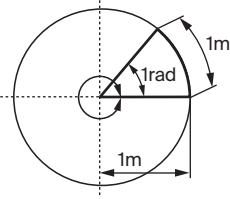
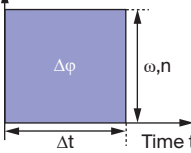
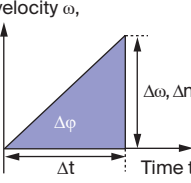
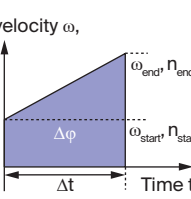
General					
	Conversion between radian and degrees (The unit <i>rad</i> is frequently omitted.)	$\text{rad} = \frac{360^\circ}{2\pi} = 57.2958^\circ$ $1^\circ = \frac{2\pi \text{ rad}}{360} = 0.01745 \text{ rad}$			
	Conversion between angular velocity and speed of rotation	$\omega = \frac{\pi}{30} \cdot n \quad n = \frac{30}{\pi} \cdot \omega$			
Uniform movement					
Angular velocity ω , Speed n		Angular velocity $\omega = \Delta\varphi / \Delta t = \text{constant}$ [ω] = rad/s	$\omega = \frac{\Delta\varphi}{\Delta t}$		
		Speed of rotation $n = 30 / \pi \cdot \Delta\varphi / \Delta t = \text{const.}$ [n] = 1/min = rpm	$n = \frac{30}{\pi} \cdot \frac{\Delta\varphi}{\Delta t}$		
Constant acceleration from a standing start					
Angular velocity ω , Speed n		Acceleration $\alpha = \Delta\omega / \Delta t = \text{constant}$ [α] = 1/s ² = rad/s ²	$\Delta\omega = \alpha \cdot \Delta t$ $\Delta n = \frac{30}{\pi} \cdot \alpha \cdot \Delta t$	$\Delta\varphi = \frac{1}{2} \cdot \alpha \cdot \Delta t^2$ $\Delta\varphi = \frac{1}{2} \cdot \frac{\pi}{30} \cdot \Delta n \cdot \Delta t$	
Constant acceleration from initial speed					
Angular velocity ω , Speed n			$\omega_{\text{end}} = \omega_{\text{start}} + \alpha \cdot \Delta t$ $n_{\text{end}} = n_{\text{start}} + \frac{30}{\pi} \cdot \alpha \cdot \Delta t$	$\Delta\varphi = \omega_{\text{start}} \cdot \Delta t + \frac{1}{2} \cdot \alpha \cdot \Delta t^2$ $\Delta\varphi = \frac{\pi}{30} \cdot n_{\text{start}} \cdot \Delta t + \frac{1}{2} \cdot \frac{\pi}{30} \cdot \Delta n \cdot \Delta t$	
Symbol	Name	SI	Symbol	Name	maxon
$t, \Delta t$	Time, duration	s	$n, \Delta n$	Speed of rotation (change)	rpm
α	Angular acceleration	rad/s ²	n_{end}	Speed after acceleration	rpm
$\Delta\varphi$	Rotation angle change	rad	n_{start}	Speed before acceleration	rpm
$\omega, \Delta\omega$	Angular velocity (change)	rad/s			
ω_{end}	Angular velocity after acceleration	rad/s			
ω_{start}	Angular velocity before acceleration	rad/s			
Remarks:					
- The shaded areas represent the angle of rotation $\Delta\varphi$ traveled during time period Δt .					
- Angle of rotation $\Delta\varphi = 2\pi \text{ rad} \cdot$ Number of revolutions = $360^\circ \cdot$ Number of revolutions					

2.3 Typical linear motion profiles

Profile	General	Symmetrical
Suitability		Travel over long distance at limited velocity
Diagram		

Task:

Travel a distance Δs in time Δt_{tot}	$v_{max} = \frac{\Delta s}{\Delta t_{tot} - \frac{\Delta t_a + \Delta t_c}{2}}$ $a_{max} = \frac{v_{max}}{\Delta t_a}$	$v_{max} = \frac{\Delta s}{(\Delta t_{tot} - \Delta t_a)}$ $a_{max} = \frac{\Delta s}{(\Delta t_{tot} - \Delta t_a) \cdot \Delta t_a}$
Travel a distance Δs at maximum velocity of v_{max}	$\Delta t_{tot} = \frac{\Delta s}{v_{max}} + \frac{\Delta t_a + \Delta t_c}{2}$ $a_{max} = \frac{v_{max}}{\Delta t_a}$	$\Delta t_{tot} = \frac{\Delta s}{v_{max}} + \Delta t_a$ $a_{max} = \frac{v_{max}}{\Delta t_a}$
Travel a distance Δs at maximum acceleration of a_{max}		$\Delta t_{tot} = \frac{\Delta s}{a_{max} \cdot \Delta t_a} + \Delta t_a$ $v_{max} = a_{max} \cdot \Delta t_a$
Complete motion in the time Δt_{tot} at maximum velocity v_{max}	$\Delta s = \left(\frac{\Delta t_a + \Delta t_c}{2} + \Delta t_b \right) \cdot v_{max}$ $a_{max} = \frac{v_{max}}{\Delta t_a}$	$\Delta s = (\Delta t_{tot} - \Delta t_a) \cdot v_{max}$ $a_{max} = \frac{v_{max}}{\Delta t_a}$
Complete motion in the time Δt_{tot} at maximum acceleration a_{max}		$\Delta s = a_{max} \cdot (\Delta t_{tot} - \Delta t_a) \cdot \Delta t_a$ $v_{max} = a_{max} \cdot \Delta t_a$
Motion at maximum velocity v_{max} and maximum acceleration a_{max}		

Symbol	Name	SI	Symbol	Name	SI
a_{max}	Maximum acceleration	m/s ²	Δt_a	Time a	s
v_{max}	Maximum velocity	m/s	Δt_b	Time b	s
Δs	Distance change	m	Δt_c	Time c	s
			Δt_{tot}	Total time	s

3/3 Trapezoidal

Optimized for minimum power (at given Δs and Δt): Most advantageous from a thermal point of view

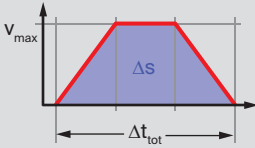

Triangle

Optimized for limited acceleration or force (at given Δs and Δt). Optimized for minimum time requirement (at given Δs and a_{max}).

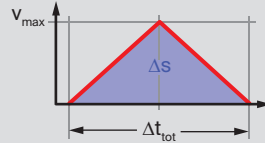

$$v_{max} = 1.5 \cdot \frac{\Delta s}{\Delta t_{tot}}$$

$$a_{max} = 4.5 \cdot \frac{\Delta s}{\Delta t_{tot}^2}$$

$$v_{max} = 2 \cdot \frac{\Delta s}{\Delta t_{tot}}$$

$$a_{max} = 4 \cdot \frac{\Delta s}{\Delta t_{tot}^2}$$

$$\Delta t_{tot} = 1.5 \cdot \frac{\Delta s}{v_{max}}$$

$$a_{max} = 2 \cdot \frac{v_{max}^2}{\Delta s}$$

$$\Delta t_{tot} = 2 \cdot \frac{\Delta s}{v_{max}}$$

$$a_{max} = \frac{v_{max}^2}{\Delta s}$$

$$\Delta t_{tot} = \frac{3}{\sqrt{2}} \cdot \sqrt{\frac{\Delta s}{a_{max}}} \approx 2.12 \cdot \sqrt{\frac{\Delta s}{a_{max}}}$$

$$v_{max} = \frac{1}{\sqrt{2}} \cdot \sqrt{\Delta s \cdot a_{max}} \approx 0.7 \cdot \sqrt{\Delta s \cdot a_{max}}$$

$$\Delta t_{tot} = 2 \cdot \sqrt{\frac{\Delta s}{a_{max}}}$$

$$v_{max} = \sqrt{\Delta s \cdot a_{max}}$$

$$\Delta s = \frac{2}{3} \cdot \Delta t_{tot} \cdot v_{max}$$

$$a_{max} = 3 \cdot \frac{v_{max}}{\Delta t_{tot}}$$

$$\Delta s = \frac{1}{2} \cdot \Delta t_{tot} \cdot v_{max}$$

$$a_{max} = 2 \cdot \frac{v_{max}}{\Delta t_{tot}}$$

$$\Delta s = \frac{2}{9} \cdot a_{max} \cdot \Delta t_{tot}^2 \approx 0.22 \cdot a_{max} \Delta t_{tot}^2$$

$$v_{max} = \frac{1}{3} \cdot a_{max} \cdot \Delta t_{tot} \approx 0.33 \cdot a_{max} \Delta t_{tot}$$

$$\Delta s = \frac{1}{4} \cdot a_{max} \cdot \Delta t_{tot}^2$$

$$v_{max} = \frac{1}{2} \cdot a_{max} \cdot \Delta t_{tot}$$

$$\Delta s = 2 \cdot \frac{v_{max}^2}{a_{max}}$$

$$\Delta t_{tot} = 3 \cdot \frac{v_{max}}{a_{max}}$$

$$\Delta s = \frac{v_{max}^2}{a_{max}}$$

$$\Delta t_{tot} = 2 \cdot \frac{v_{max}}{a_{max}}$$

Symbol Name
 a_{max} Maximum acceleration
 v_{max} Maximum velocity

SI
 m/s^2
 m/s

Symbol Name
 Δs Distance change
 Δt_{tot} Total time

SI
 m
 s

2.4 Typical rotary motion profiles

Profile	General	Symmetrical
Suitability		Long rotation at limited speed of rotation
Diagram		

Task:

Travel an angle $\Delta\varphi$ in time Δt_{tot}	$n_{max} = \frac{30}{\pi} \cdot \frac{\Delta\varphi}{\Delta t_{tot} - \frac{\Delta t_a + \Delta t_c}{2}}$ $\alpha_{max} = \frac{\Delta\varphi}{\left(\Delta t_{tot} - \frac{\Delta t_a + \Delta t_c}{2}\right) \cdot \Delta t_a}$	$n_{max} = \frac{30}{\pi} \cdot \frac{\Delta\varphi}{(\Delta t_{tot} - \Delta t_a)}$ $\alpha_{max} = \frac{\Delta\varphi}{(\Delta t_{tot} - \Delta t_a) \cdot \Delta t_a}$
Travel an angle $\Delta\varphi$ at maximum speed n_{max}	$\Delta t_{tot} = \frac{30}{\pi} \cdot \frac{\Delta\varphi}{n_{max}} + \frac{\Delta t_a + \Delta t_c}{2}$ $\alpha_{max} = \frac{\pi}{30} \cdot \frac{n_{max}}{\Delta t_a}$	$\Delta t_{tot} = \frac{30}{\pi} \cdot \frac{\Delta\varphi}{n_{max}} + \Delta t_a$ $\alpha_{max} = \frac{\pi}{30} \cdot \frac{n_{max}}{\Delta t_a}$
Travel an angle $\Delta\varphi$ at maximum angular acceleration α_{max}		$\Delta t_{tot} = \frac{\Delta\varphi}{\alpha_{max}} \cdot \Delta t_a + \Delta t_a$ $n_{max} = \frac{30}{\pi} \cdot \alpha_{max} \cdot \Delta t_a$
Complete motion in the time Δt_{tot} at maximum speed n_{max}	$\Delta\varphi = \frac{\pi}{30} \cdot n_{max} \cdot \left(\frac{\Delta t_a + \Delta t_c}{2} + \Delta t_b\right)$ $\alpha_{max} = \frac{\pi}{30} \cdot \frac{n_{max}}{\Delta t_a}$	$\Delta\varphi = \frac{\pi}{30} \cdot n_{max} \cdot (\Delta t_{tot} - \Delta t_a)$ $\alpha_{max} = \frac{\pi}{30} \cdot \frac{n_{max}}{\Delta t_a}$
Complete motion in the time Δt_{tot} at maximum angular acceleration α_{max}		$\Delta\varphi = \alpha_{max} \cdot (\Delta t_{tot} - \Delta t_a) \cdot \Delta t_a$ $n_{max} = \frac{30}{\pi} \cdot \alpha_{max} \cdot \Delta t_a$
Motion at maximum speed n_{max} and maximum angular acceleration α_{max}		

Symbol	Name	SI	Symbol	Name	SI
α_{max}	Maximum angular acceleration	rad/s ²	$\Delta\varphi$	Rotation angle change	rad
Δt_a	Time a	s			
Δt_b	Time b	s	Symbol	Name	maxon
Δt_c	Time c	s	n_{max}	Maximum speed in load cycle	rpm
Δt_{tot}	Total time	s			

3/3 Trapezoidal

Optimized for minimum power (at given $\Delta\varphi$ and Δt): Most advantageous from a thermal point of view

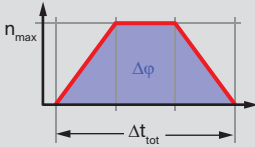

Triangle

Optimized for limited angular acceleration or torque (at given $\Delta\varphi$ and Δt) and for minimum time requirement (at given $\Delta\varphi$ and α_{max}).

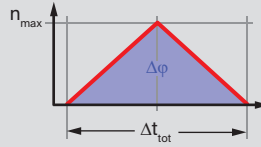

$$n_{max} = 1.5 \cdot \frac{30}{\pi} \cdot \frac{\Delta\varphi}{\Delta t_{tot}}$$

$$\alpha_{max} = 4.5 \cdot \frac{\Delta\varphi}{\Delta t_{tot}^2}$$

$$\Delta t_{tot} = 1.5 \cdot \frac{30}{\pi} \cdot \frac{\Delta\varphi}{n_{max}}$$

$$\alpha_{max} = 2 \cdot \frac{\pi^2}{30^2} \cdot \frac{n_{max}^2}{\Delta\varphi}$$

$$\Delta t_{tot} = \frac{3}{\sqrt{2}} \cdot \sqrt{\frac{\Delta\varphi}{\alpha_{max}}} \approx 2.12 \cdot \sqrt{\frac{\Delta\varphi}{\alpha_{max}}}$$

$$n_{max} = \frac{1}{\sqrt{2}} \cdot \frac{30}{\pi} \cdot \sqrt{\Delta\varphi \cdot \alpha_{max}} \approx 6.75 \cdot \sqrt{\Delta\varphi \cdot \alpha_{max}}$$

$$\Delta\varphi = \frac{2}{3} \cdot \frac{\pi}{30} \cdot \Delta t_{tot} \cdot n_{max}$$

$$\alpha_{max} = 3 \cdot \frac{\pi}{30} \cdot \frac{n_{max}}{\Delta t_{tot}}$$

$$\Delta\varphi = \frac{2}{9} \cdot \alpha_{max} \cdot \Delta t_{tot}^2 \approx 0.22 \cdot \alpha_{max} \cdot \Delta t_{tot}^2$$

$$n_{max} = \frac{1}{3} \cdot \frac{30}{\pi} \cdot \alpha_{max} \cdot \Delta t_{tot} \approx 3.18 \cdot \alpha_{max} \cdot \Delta t_{tot}$$

$$\Delta\varphi = 2 \cdot \frac{30}{\pi} \cdot \frac{n_{max}^2}{\alpha_{max}}$$

$$\Delta t_{tot} = 3 \cdot \frac{\pi}{30} \cdot \frac{n_{max}}{\alpha_{max}}$$

$$n_{max} = 2 \cdot \frac{30}{\pi} \cdot \frac{\Delta\varphi}{\Delta t_{tot}}$$

$$\alpha_{max} = 4 \cdot \frac{\Delta\varphi}{\Delta t_{tot}^2}$$

$$\Delta t_{tot} = 2 \cdot \frac{30}{\pi} \cdot \frac{\Delta\varphi}{n_{max}}$$

$$\alpha_{max} = \frac{\pi^2}{30^2} \cdot \frac{n_{max}^2}{\Delta\varphi}$$

$$\Delta t_{tot} = 2 \cdot \sqrt{\frac{\Delta\varphi}{\alpha_{max}}}$$

$$n_{max} = \frac{30}{\pi} \cdot \sqrt{\Delta\varphi \cdot \alpha_{max}}$$

$$\Delta\varphi = \frac{1}{2} \cdot \frac{\pi}{30} \cdot \Delta t_{tot} \cdot n_{max}$$

$$\alpha_{max} = 2 \cdot \frac{\pi}{30} \cdot \frac{n_{max}}{\Delta t_{tot}}$$

$$\Delta\varphi = \frac{1}{4} \cdot \alpha_{max} \cdot \Delta t_{tot}^2$$

$$n_{max} = \frac{1}{2} \cdot \frac{30}{\pi} \cdot \alpha_{max} \cdot \Delta t_{tot}$$

$$\Delta\varphi = \frac{30}{\pi} \cdot \frac{n_{max}^2}{\alpha_{max}}$$

$$\Delta t_{tot} = 2 \cdot \frac{\pi}{30} \cdot \frac{n_{max}}{\alpha_{max}}$$

Symbol Name

α_{max} Maximum angular acceleration

Δt_{tot} Total time

$\Delta\varphi$ Rotation angle change

SI

rad/s²

s

rad

Symbol Name

n_{max} Maximum speed in load cycle

maxon

rpm

Notes

3. Mechanical drives

3.1 Mechanical transmission

Classification	Output power /transmission, general
<div style="text-align: center; background-color: #333; color: white; padding: 5px; margin-bottom: 10px;">Linear</div> <pre> graph TD L[Linear] --- S[Screw] L --- RP[Rack and pinion] L --- CB[Conveyor belt] L --- ED[Eccentric drive] L --- R[Rover] S --- BS[Ball screw] S --- TS[Trapezoidal screw] CB --- C[Crane] ED --- CS[Crankshaft] </pre>	<p>Output power, linear motion</p> $[W] = m/s \cdot N$ $P_{mech} = v \cdot F$ <p>Transmission, general</p> $P_{L,mech} = \frac{P_{in,mech}}{\eta}$ $v_L \cdot F_L = \frac{\omega_{in} \cdot M_{in}}{\eta}$
<div style="text-align: center; background-color: #333; color: white; padding: 5px; margin-bottom: 10px;">Rotation</div> <pre> graph TD R[Rotation] --- GH[Gearhead] R --- B[Belt] R --- SD[Special design] GH --- SG[Spur geared] GH --- PG[Planetary gearhead] GH --- BG[Bevel gear] GH --- WG[Worm gear] GH --- WFG[Wolfrom gear] B --- TB[Toothed belt] B --- CD[Chain drive] SD --- CG[Cyclo gear] SD --- HD[Harmonic Drive®] </pre>	<p>Output power, rotary motion</p> $[W] = s^{-1} \cdot Nm$ $P_{mech} = \omega \cdot M = \frac{\pi}{30} \cdot n \cdot M$ <p>Transmission, general</p> $P_{L,mech} = \frac{P_{in,mech}}{\eta}$ $\omega_L \cdot M_L = \frac{\omega_{in} \cdot M_{in}}{\eta}$
Designations in the formulae	
<ul style="list-style-type: none"> - The load-side variables at the output are identified by the index <i>L</i>. - The input-side variables (usually the motor) are identified by the index <i>in</i>. 	

Symbol	Name	SI	Symbol	Name	SI
<i>F</i>	Force	N	<i>v_L</i>	Load velocity	m/s
<i>F_L</i>	Load force (output)	N	<i>η</i>	Efficiency	
<i>M</i>	Torque	Nm	<i>ω</i>	Angular velocity	rad/s
<i>M_{in}</i>	Input torque	Nm	<i>ω_L</i>	Angular velocity load	rad/s
<i>M_L</i>	Load torque	Nm	<i>ω_{in}</i>	Angular velocity input	rad/s
<i>P_{in,mech}</i>	Mechanical input power	W	Symbol	Name	maxon
<i>P_{L,mech}</i>	Mechanical output power	W	<i>n</i>	Speed of rotation	rpm
<i>P_{mech}</i>	Mechanical power	W			
<i>v</i>	Velocity	m/s			

3.2 Mechanical drives, rotation → linear

Screw drive

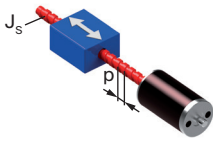

Speed of rotation

$$n_{in} = \frac{60}{p} \cdot v_L$$

Torque

$$M_{in} = \frac{p}{2\pi} \cdot \frac{F_L}{\eta}$$

Additional torque for constant acceleration
(speed change Δn_{in} during period Δt_a)

$$M_{in,\alpha} = \left(J_{in} + J_s + \frac{m_L + m_s}{\eta} \cdot \frac{p^2}{4\pi^2} \right) \cdot \frac{\pi}{30} \cdot \frac{\Delta n_{in}}{\Delta t_a}$$

Play, position error

$$\Delta\varphi_{in} = \Delta s_L \cdot \frac{2\pi}{p}$$

Belt drive / conveyor belt / crane

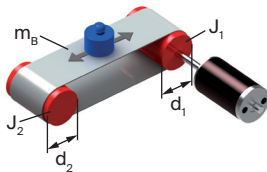

Speed of rotation

$$n_{in} = \frac{60}{\pi} \cdot \frac{v_L}{d_1} \quad (\text{Assumption: no slip})$$

Torque

$$M_{in} = \frac{d_1}{2} \cdot \frac{F_L}{\eta}$$

Additional torque for constant acceleration
(speed change Δn_{in} during period Δt_a)

$$M_{in,\alpha} = \left(J_{in} + J_1 + \frac{J_2}{\eta} \cdot \frac{d_1^2}{d_2^2} + \frac{J_X}{\eta} \cdot \frac{d_1^2}{d_X^2} + \frac{m_L + m_B}{\eta} \cdot \frac{d_1^2}{4} \right) \cdot \frac{\pi}{30} \cdot \frac{\Delta n_{in}}{\Delta t_a}$$

Play, position error

$$\Delta\varphi_{in} = \Delta s_L \cdot \frac{2}{d_1}$$

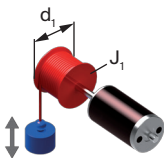

Symbol	Name	SI	Symbol	Name	SI
F_L	Load force (output)	N	m_L	Mass of the load	kg
J_{in}	Moment of inertia, input (motor, encoder, brake)	kgm ²	m_s	Mass, screw nut	kg
J_s	Moment of inertia, screw	kgm ²	p	Screw lead (pitch)	m
J_X	Moment of inertia, deflector pulley X	kgm ²	v_L	Load velocity	m/s
J_1	Moment of inertia, driving end	kgm ²	Δs_L	Mechanical play, load	m
J_2	Moment of inertia, deflector pulley 2	kgm ²	Δt_a	Acceleration time	s
M_{in}	Input torque	Nm	$\Delta\varphi_{in}$	Mechanical play, input	rad
$M_{in,\alpha}$	Torque for acceleration	Nm	η	Efficiency	
d_X	Diameter, deflector pulley X	m	Symbol	Name	maxon
d_1	Diameter, drive pulley	m	n_{in}	Input speed	rpm
d_2	Diameter, deflector pulley 2	m	Δn_{in}	Speed change, input	rpm
m_B	Mass, belt	kg			

Rack-and-pinion drive

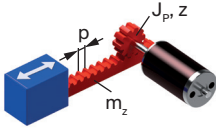

Speed of rotation

$$n_{in} = \frac{60}{p \cdot z} \cdot v_L$$

Torque

$$M_{in} = \frac{p \cdot z}{2\pi} \cdot \frac{F_L}{\eta}$$

Additional torque for constant acceleration
(speed change Δn_{in} during period Δt_a)

$$M_{in,\alpha} = \left(J_{in} + J_p + \frac{m_L + m_z}{\eta} \cdot \frac{p^2 \cdot z^2}{4\pi^2} \right) \cdot \frac{\pi}{30} \cdot \frac{\Delta n_{in}}{\Delta t_a}$$

Play, position error

$$\Delta\varphi_{in} = \Delta s_L \cdot \frac{2\pi}{p \cdot z}$$

Rover

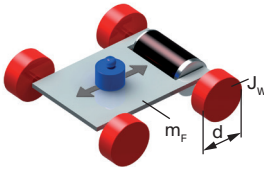

Speed of rotation

$$n_{in} = \frac{60}{\pi} \cdot \frac{v_L}{d} \quad (\text{Assumption: no slip})$$

Torque

$$M_{in} = \frac{d}{2} \cdot \frac{F_L}{\eta}$$

Additional torque for constant acceleration
(speed change Δn_{in} during period Δt_a)

$$M_{in,\alpha} = \left(J_{in} + J_w + \frac{m_L + m_F}{\eta} \cdot \frac{d^2}{4} \right) \cdot \frac{\pi}{30} \cdot \frac{\Delta n_{in}}{\Delta t_a}$$

Play, position error

$$\Delta\varphi_{in} = \Delta s_L \cdot \frac{2}{d}$$

Symbol	Name	SI	Symbol	Name	SI
F_L	Load force (output)	N	m_z	Mass, gear rack	kg
J_{in}	Moment of inertia, input (motor, encoder, brake)	kgm ²	p	Pitch	m
J_p	Moment of inertia, pinion	kgm ²	v_L	Load velocity	m/s
J_w	Moment of inertia, all wheels together	kgm ²	z	Number of teeth, pinion	
M_{in}	Input torque	Nm	Δs_L	Mechanical play, load	m
$M_{in,\alpha}$	Torque for acceleration	Nm	Δt_a	Acceleration time	s
d	Diameter, drive wheel	m	$\Delta\varphi_{in}$	Mechanical play, input	rad
m_F	Mass, rover	kg	η	Efficiency	
m_L	Mass of the load	kg			
			Symbol	Name	maxon
			n_{in}	Input speed	rpm
			Δn_{in}	Speed change, input	rpm

Eccentric drive

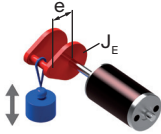

Sinusoidal velocity curve of the load
(assumption: constant input speed n_{in})

$$v_L(t) = \frac{\pi}{30} \cdot n_{in} \cdot e \cdot \sin\left(\frac{\pi}{30} \cdot n_{in} \cdot t\right)$$

Angle-dependent periodic acceleration force for load, pistons and rods (m_L)

$$F_a(\varphi) = F_a \cdot \cos \varphi = m_L \cdot \left(\frac{\pi}{30} \cdot n_{in}\right)^2 \cdot e \cdot \cos \varphi$$

Angle-dependent torques due to different load conditions in the two half cycles of the back and forth motion.

$$\begin{aligned} M_{in1}(\varphi) &= e \cdot (F_{L1} \cdot \sin \varphi + F_{a1} \cdot \cos \varphi) & 0 \leq \varphi \leq \pi \\ M_{in2}(\varphi) &= e \cdot (F_{L2} \cdot \sin \varphi + F_{a2} \cdot \cos \varphi) & \pi \leq \varphi \leq 2\pi \end{aligned}$$

Average effective torque load

$$M_{in,RMS} = \frac{e}{\sqrt{2} \cdot \eta} \cdot \sqrt{F_{L1}^2 + F_{a1}^2 + F_{L2}^2 + F_{a2}^2}$$

Additional torque for acceleration of the eccentric disc
(speed change Δn_{in} during period Δt_a)

$$M_{in,\alpha} = (J_{in} + J_E) \cdot \frac{\pi}{30} \cdot \frac{\Delta n_{in}}{\Delta t_a}$$

Symbol	Name	SI	Symbol	Name	SI
F_{L1}	Load force 1 st half cycle	N	e	Eccentricity	m
F_{L2}	Load force 2 nd half cycle	N	m_L	Mass of the load	kg
F_a	Acceleration force	N	$v_L(t)$	Sinusoidal velocity curve of the load	m/s
$F_a(\varphi)$	Periodic acceleration force as a function of the angle of rotation	N	t	Time	s
F_{a1}	Acceleration force, 1 st /2 nd half cycle	N	Δt_a	Acceleration time	s
F_{a2}	Acceleration force, 1 st /2 nd half cycle	N	φ	Rotation angle	rad
J_{in}	Moment of inertia, input (motor, encoder, brake)	kgm ²	η	Efficiency	
J_E	Moment of inertia, eccentric disc	kgm ²	Symbol	Name	maxon
$M_{in,RMS}$	RMS torque	Nm	n_{in}	Input speed	rpm
$M_{in,\alpha}$	Torque for acceleration	Nm	Δn_{in}	Speed change, input	rpm
$M_{in1}(\varphi)$	Torque, 1 st half cycle	Nm			
$M_{in2}(\varphi)$	Torque, 2 nd half cycle	Nm			

3.3 Mechanical drives, rotation → rotation

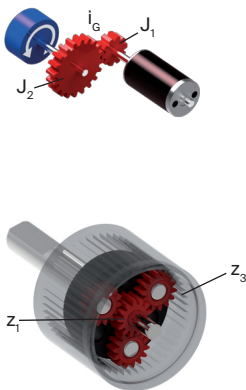
Gearhead		
	Speed of rotation	$n_{in} = n_L \cdot i_G$
	Torque	$M_{in} = \frac{M_L}{i_G \cdot \eta}$
	Additional torque for constant acceleration (speed change Δn_{in} during period Δt_a)	$M_{in,a} = \left(J_{in} + J_1 + \frac{J_L + J_2}{i_G^2 \cdot \eta} \right) \cdot \frac{\pi}{30} \cdot \frac{\Delta n_{in}}{\Delta t_a} = \left(J_{in} + J_G + \frac{J_L}{i_G^2 \cdot \eta} \right) \cdot \frac{\pi}{30} \cdot \frac{\Delta n_{in}}{\Delta t_a}$
	Play, position error	$\Delta \varphi_{in} = \Delta \varphi_L \cdot i_G$
	Reduction ratio planetary gearhead	$i_G = \frac{Z_1 + Z_3}{Z_1}$

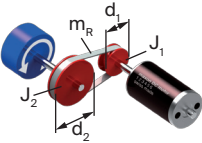
Belt drive		
	Speed of rotation	$n_{in} = n_L \cdot \frac{d_2}{d_1}$ (Assumption: no slip)
	Torque	$M_{in} = \frac{d_1}{d_2} \cdot \frac{M_L}{\eta}$
	Additional torque for constant acceleration (speed change Δn_{in} during period Δt_a)	$M_{in,a} = \left(J_{in} + J_1 + \frac{J_L + J_2}{\eta} \cdot \frac{d_1^2}{d_2^2} + \frac{J_x}{\eta} \cdot \frac{d_1^2}{d_x^2} + \frac{m_R \cdot d_1^2}{4 \cdot \eta} \right) \cdot \frac{\pi}{30} \cdot \frac{\Delta n_{in}}{\Delta t_a}$
	Play, position error	$\Delta \varphi_{in} = \Delta \varphi_{out} \cdot \frac{d_2}{d_1}$

Symbol	Name	SI	Symbol	Name	SI
J_G	Moment of inertia, gearhead transformed	kgm ²	i_G	Reduction ratio, gearhead (catalog value)	
J_{in}	Moment of inertia, input (motor, encoder, brake)	kgm ²	m_R	Mass, belt	kg
J_L	Moment of inertia, load	kgm ²	Z_1	Number of teeth, sun wheel	
J_x	Moment of inertia, deflector pulley X	kgm ²	Z_3	Number of teeth, internal gear	
J_1	Moment of inertia, driving end	kgm ²	Δt_a	Acceleration time	s
J_2	Moment of inertia, load	kgm ²	$\Delta \varphi_{in}$	Mechanical play, input	rad
M_{in}	Input torque	Nm	$\Delta \varphi_L$	Mechanical play, load	rad
$M_{in,a}$	Torque for acceleration	Nm	η	Efficiency	
M_L	Load torque	Nm	Symbol	Name	maxon
d_x	Diameter, deflector pulley X	m	n_{in}	Input speed	rpm
d_1	Diameter, drive pulley	m	n_L	Load speed	rpm
d_2	Diameter, load pulley	m	Δn_{in}	Speed change, input	rpm

3.4 maxon gear

Identification system for maxon-gearheads

Gearhead design type

- GS Spur gearhead
- GP Planetary gearhead
- GPX Configurable planetary gearhead
- KD Koaxdrive



Diameter
in mm

Version

- A Metal version
- AR, CR High Radial loads
- B Version with enlarged internal gear
- C Ceramic version
- HD Heavy Duty – for applications in oil
- HP High Power version
- UP Ultra high Performance
- K Plastic version
- LN Low Noise version
- SPEED High input speeds
- S Screw drive with axial bearing
- V Reinforced version
- _Z, LZ Low backlash version

Operating ranges of gearheads

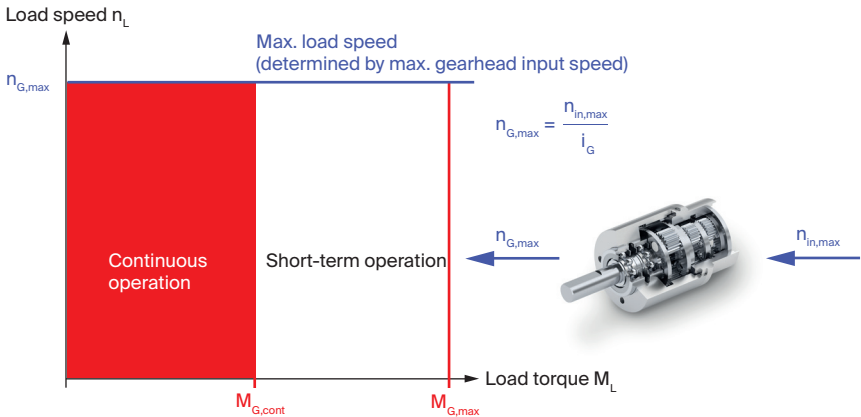

maxon-gearheads are designed for an operating life of at least 1000 hours at the given maximum continuous torque and maximum input speed ratings. Operation below these limits will significantly increase operating life. If the limits are exceeded, the useful life of the gearhead may be reduced.



Symbol	Name	SI	Symbol	Name	maxon
$M_{G,cont}$	Max. continuous torque, gearhead (catalog value)	Nm	$n_{G,max}$	Maximum output speed gearhead	rpm
$M_{G,max}$	Max. intermittent torque, gearhead (catalog value)	Nm	$n_{in,max}$	Maximum input speed (catalog value)	rpm
i_G	Reduction ratio, gearhead (catalog value)				

4. Bearing

4.1 Comparison of characteristics of sintered sleeve bearings and ball bearings

	Sintered sleeve bearings	Ball bearings
		
Operating modes	<ul style="list-style-type: none"> - continuous operation 	<ul style="list-style-type: none"> - suitable for all types of operations - especially for start-stop operations and low-speed applications
Speed range	<ul style="list-style-type: none"> - ideal above approx. 500 rpm (range for hydrodynamic lubrication) - with special material pairing and lubrication even at lower speeds 	<ul style="list-style-type: none"> - up to several 10 000 rpm - in special cases up to 100 000 rpm and higher (e.g. with ceramic balls)
Radial / axial load	<ul style="list-style-type: none"> - only small bearing loads 	<ul style="list-style-type: none"> - higher loads - preloaded ball bearings permit axial loads up to the value of the preload.
Additional operating criteria	<ul style="list-style-type: none"> - typical in small DC motors up to approx. 30 mm diameter and in spur gearheads - not suitable for rotating load - not suitable for vacuum applications (outgassing) - not suitable for low temperatures (< -20°C) 	<ul style="list-style-type: none"> - typical in DC motors above 10 mm diameter and in planetary gearheads - preloaded ball bearings typical in brushless DC motors guaranteeing a very long life and smooth operation
Bearing play	<ul style="list-style-type: none"> - axial: typically 0.05 ... 0.15 mm - radial: typically 0.014 mm 	<ul style="list-style-type: none"> - axial: typically 0.05 ... 0.15 mm (no axial play if preloaded) - radial: typically 0.025 mm
Coefficient of friction, typical	<ul style="list-style-type: none"> - 0.001 ... 0.01 (hydrodynamic lubrication) 	<ul style="list-style-type: none"> - 0.001 ... 0.1
Lubrication	<ul style="list-style-type: none"> - hydrodynamic lubrication only at high speeds - shaft bearing material very important, pore size of the sintered bearing and viscosity of the lubricant at operating temperature are critical - special: sintered iron bearings with ceramic shaft for high radial loads and long operating life 	<ul style="list-style-type: none"> - temperature range for standard lubrication: typically -20 ... 100 °C - special lubrication possible for very high or very low operating temperatures - sealing possible (but higher friction, shorter life and lower speed limit)
Costs	economical	more expensive

Notes

5. Electrical principles

5.1 Principles of DC (Direct Current)

Electric power

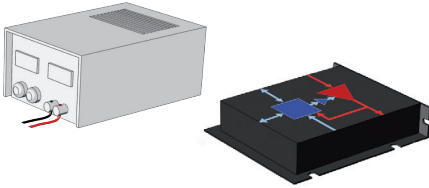

Power:
 $[P] = V \cdot A = VA$
 $= W = J/s$

$$P = U \cdot I = R \cdot I^2 = \frac{U^2}{R}$$

Power loss:

$$P_V = R \cdot I^2$$

Power adjustment

At $R_L = R_i$ the maximum power is drawn from a voltage source.

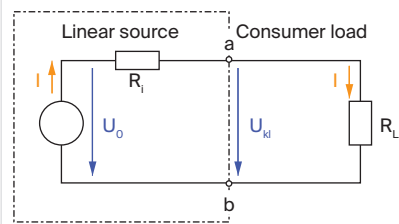
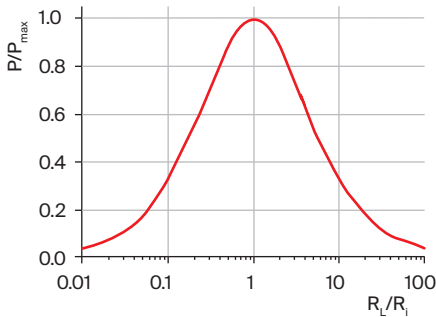

$$P_{max} = \frac{U_0^2}{4 \cdot R_i} = I^2 \cdot R_i$$

Ohm's law

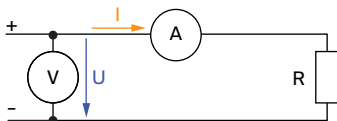

$$U = R \cdot I$$

$$I = \frac{U}{R}$$

$$R = \frac{U}{I}$$

Symbol	Name	SI	Symbol	Name	SI
I	Current	A	R_i	Inner resistance, voltage source	Ω
P	Power	W	R_L	Load resistance	Ω
P_{max}	Maximum power	W	U	Voltage	V
P_V	Power losses	W	U_0	Source voltage	V
R	Electrical resistance	Ω	U_{kl}	Terminal voltage	V

Electrical time constant

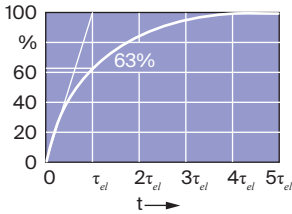

The electrical time constant describes the reaction time of the current when switching on or off a voltage.

Current change with inductive load

$$\tau_{el} = \frac{L}{R}$$

Voltage change with capacitive load

$$\tau_{el} = R \cdot C$$

$$[\tau_{el}] = H/\Omega = Vs/A/\Omega = s$$

$$[\tau_{el}] = \Omega \cdot F = \Omega \cdot As/V = s$$

Pull-up/pull-down

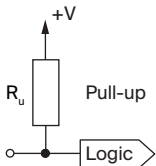

Pull-up: (relatively high-impedance) resistor

- Connects signal line with higher voltage potential
- Pulls the line up to the higher potential, if no external voltage actively pulls the line to a lower potential

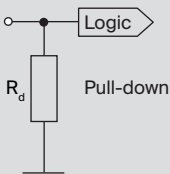

Pull-down: (relatively high-impedance) resistor

- Connects signal line with lower voltage potential
- Pulls the line down to the lower potential, if no external voltage actively pulls the line to a higher potential

Open-collector output

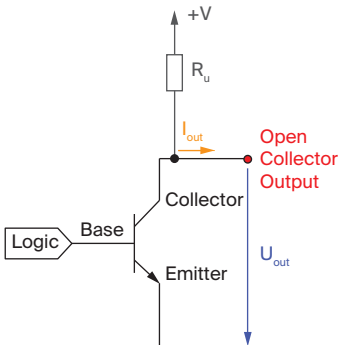

Open-collector output (OC):

- Output of an integrated circuit with a bipolar transistor with an open collector output.
- Usually the outputs are used in combination with a pull-up resistor which raises the output voltage to a higher potential in the inactive state.

$$U_{out} = +V - (I_{out} \cdot R_u)$$

Hall sensors usually have an open-collector output without pull-up resistor. Therefore, it is integrated into the maxon controllers.

Symbol	Name	SI	Symbol	Name	SI
C	Capacitance		F	Time	s
I_{out}	Output current	A	U_{in}	Input voltage	V
L	Inductance	H	U_{out}	Output voltage	V
R	Electrical resistance	Ω	+V	Supply voltage	V
R_d	Pull-down resistance	Ω	τ_{el}	Electrical time constant	s
R_u	Pull-up resistance	Ω			

5.2 Electrical resistive circuits

Series resistor circuits

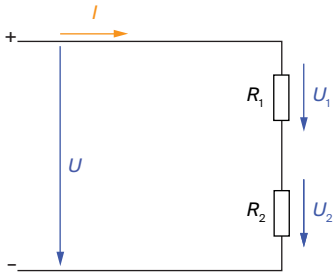

$I = \text{constant}$

$$U = U_1 + U_2 + \dots$$

$$R = R_1 + R_2 + \dots$$

$$\frac{U_1}{U_2} = \frac{R_1}{R_2}$$

Parallel resistor circuits

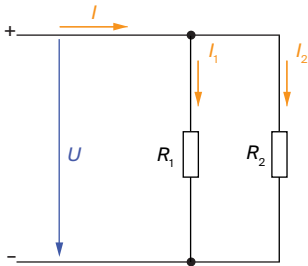

$U = \text{constant}$

$$I = I_1 + I_2 + \dots$$

$$\frac{1}{R} = \frac{1}{R_1} + \frac{1}{R_2} + \dots$$

$$R = \frac{R_1 \cdot R_2}{R_1 + R_2}$$

$$\frac{I_1}{I_2} = \frac{R_2}{R_1}$$

Symbol	Name	SI	Symbol	Name	SI
I	Total current	A	R_1, R_2	Partial resistances	Ω
I_1, I_2	Partial currents	A	U	Total voltage	V
R	Equivalent resistance	Ω	U_1, U_2	Partial voltages	V

Voltage divider, no-load

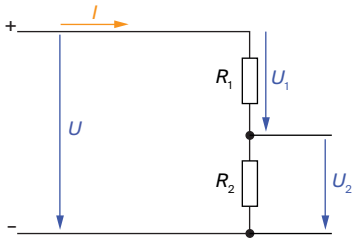

$$U_2 = U \cdot \frac{R_2}{R_1 + R_2}$$

$$\frac{U_1}{U_2} = \frac{R_1}{R_2}$$

$$I = \frac{U_2}{R_2} = \frac{U}{R_1 + R_2}$$

Voltage divider, under load

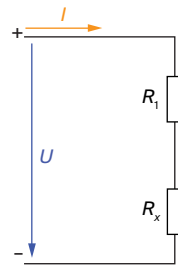
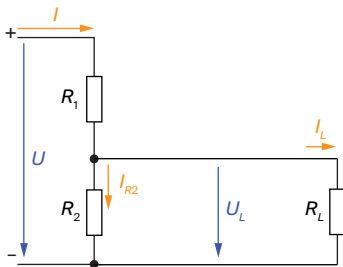

$$U_L = U \cdot \frac{R_x}{R_x + R_1}$$

$$R_x = \frac{R_L \cdot R_2}{R_L + R_2}$$

$$I_L = I \cdot \frac{R_2}{R_L + R_2}$$

$$I_{R2} = I \cdot \frac{R_L}{R_L + R_2}$$

Potentiometer

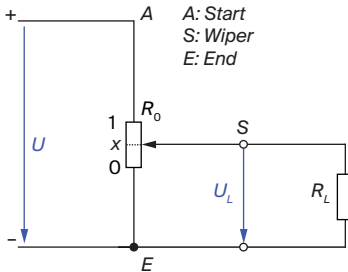

No-load

$$R = x \cdot R_0$$

$$U_L = x \cdot U$$

Under load

$$U_L = U \cdot \frac{x}{\left(\frac{R_0}{R_L}(x - x^2)\right) + 1}$$

Winding resistance

Temperature-dependence

$$R_{TW} = R_{mot} \cdot (1 + \alpha_{Cu} \cdot (T_w - 25 \text{ C}^\circ))$$

Symbol	Name	SI	Symbol	Name	SI
I	Total current	A	R_{TW}	Winding resistance at current temp. T_w	Ω
I_L	Load current	A	U	Total voltage	V
I_{R2}	Current through resistor R_2	A	U_1, U_2	Partial voltages	V
R	Equivalent resistance	Ω	U_L	Load voltage	V
R_0	Resistance, potentiometer	Ω	T_w	Winding temperature	$^\circ\text{C}$
R_1, R_2	Partial resistances	Ω	x	Potentiometer position	0..1
R_L	Load resistance	Ω			
R_{mot}	Terminal resistance, motor (catalog value)	Ω	Symbol	Name	Value
R_x	Equivalent resistance of R_2 and R_L	Ω	α_{Cu}	Resistance coefficient, copper	0.0039 K^{-1}

5.3 Principles of AC (Alternating Current)

Alternating quantities

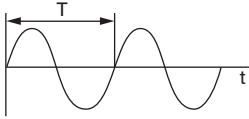

Frequency
 $[f] = 1/\text{s} = \text{Hz}$

$$f = \frac{1}{T}$$

Angular frequency
 $[\omega] = 1/\text{s} = \text{rad/s}$

$$\omega = 2\pi \cdot f$$

Ohm's law

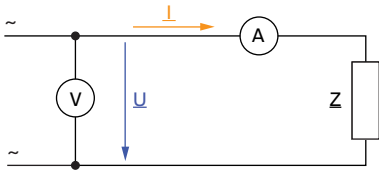

$$U = Z \cdot I$$

$$I = \frac{U}{Z}$$

$$Z = \frac{U}{I}$$

Resistances

Reactance



Inductive:

$$X_L = \omega \cdot L = 2\pi \cdot f \cdot L$$

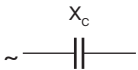

Capacitive:

$$X_C = \frac{1}{\omega \cdot C} = \frac{1}{2\pi \cdot f \cdot C}$$

Impedance (AC resistance) $Z = |Z|$

For series connection of R and L , or R and C

$$Z = \sqrt{R^2 + X^2}$$

Symbol	Name	SI	Symbol	Name	SI
C	Capacitance	F	X	Stands for X_C or X_L	Ω
I	Current	A	X_C	Reactance, capacitive	Ω
L	Inductance	H	X_L	Reactance, inductive	Ω
R	Electrical resistance	Ω	Z	Impedance	Ω
T	Period	s	f	Frequency	Hz
U	Voltage	V	t	Time	s
			ω	Angular frequency	rad/s

5.4 Simple filters

General

Cut-off frequency f_c

$$f_c = \frac{1}{2\pi \cdot R \cdot C} \quad \text{or} \quad f_c = \frac{R}{2\pi \cdot L}$$

Phase shift

$$\cos\varphi = \frac{U_{out}}{U_{in}}$$

Low-pass filters, integral element

Allow frequencies to pass virtually unaffected below their cut-off frequency f_c .

Higher frequencies are damped.

Applications: maxon controller inputs, commutation signal measurement of maxon motors.

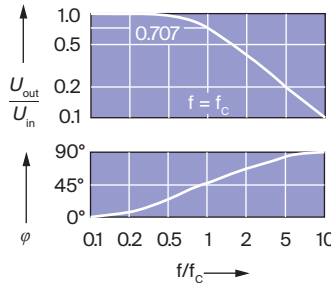
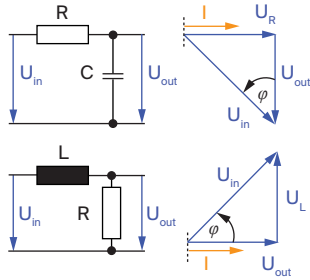

$$\frac{U_{out}}{U_{in}} = \frac{1}{\sqrt{1 + (f/f_c)^2}}$$

$$U_{out} = U_{in} \frac{X_c}{\sqrt{R^2 + X_c^2}}$$

$$U_{out} = U_{in} \frac{R}{\sqrt{R^2 + X_L^2}}$$

High-pass filter, derivative element

Allow frequencies to pass virtually unaffected above their cut-off frequency f_c .

Lower frequencies are damped.

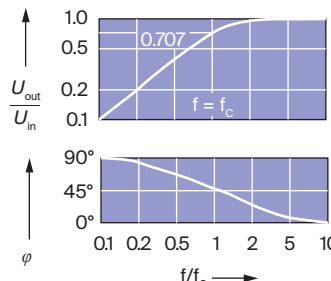
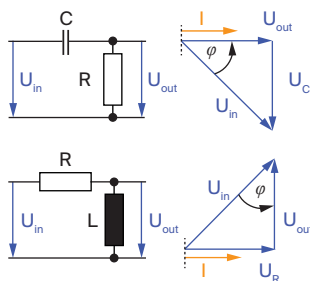

$$\frac{U_{out}}{U_{in}} = \frac{1}{\sqrt{1 + (f_c/f)^2}}$$

$$U_{out} = U_{in} \frac{R}{\sqrt{R^2 + X_c^2}}$$

$$U_{out} = U_{in} \frac{X_L}{\sqrt{R^2 + X_L^2}}$$

Symbol	Name	SI	Symbol	Name	SI
C	Capacitance		F	U_{out}	V
I	Current		A	U_R	V
L	Inductance		H	X_C	Ω
R	Electrical resistance		Ω	X_L	Ω
U_C	Voltage over capacitance		V	f	Hz
U_{in}	Input voltage		V	f_c	Hz
U_L	Voltage over inductance		V	φ	$^\circ$

6. maxon motors

6.1 General

What is special about maxon motors?

The heart of the maxon motor is the **self-supporting ironless copper winding**.

Outstanding features of the maxon DC motors:

- High efficiency → Low power consumption
- Very low moment of inertia → Highest acceleration
- Low inductance → Long service life
- Compact design → Good volume / power ratio
- No magnetic cogging
- Low electromagnetic interference
- High reliability

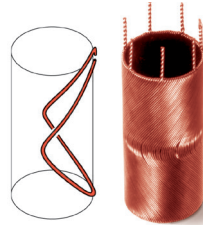

maxon DC motor (brushed permanent-magnet energized DC motors)

DCX range

- Online configurable
- High performance thanks to NdFeB-Magnet
- Dynamic and high efficiency



Ø6 – 35 mm

DC-max range

- Online configurable
- High performance at low costs
- Combines design of the A-max motors with NdFeB magnets
- Automated manufacturing process



Ø16 – 26 mm

RE range

- High power density
- High-quality DC motor with NdFeB magnet
- High speeds and torques
- Robust design (metal flange)



Ø6 – 65 mm

A-max range

- Good price / performance ratio
- DC motor with AlNiCo magnet
- Automated manufacturing process



Ø12 – 32 mm

Properties of the two brush systems

Graphite brushes

- Well suited for high currents and peak currents
- Well suited for start-stop and reverse operation
- Larger motors (from approx. 10 W)
- Higher friction, higher no-load current
- Not suited for low currents
- Higher audible noise
- Higher electromagnetic emissions
- More complex and higher costs



Precious metal brushes

- Well suited for lowest currents and voltages
- Well suited for continuous operation
- Smaller motors
- Very low friction, low audible noise
- Low electromagnetic emissions
- Cost effective
- Not suited for high currents and peak currents
- Not suited for start-stop operation



maxon EC motor

Brushless DC motors (BLDC motors)

- Motor behavior similar to brushed DC motor
- Design similar to synchronous motor (3-phase stator winding, rotating permanent magnet)
- Powering of the 3 phases according to the rotor position by a commutation electronics

ECX range

- Online configurable
- Power-optimized, with high speeds up to 120 000 rpm
- Robust design
- Various types: e.g. short-long, sterilizable



Ø6–22 mm

EC range

- Power-optimized, with high speeds up to 100 000 rpm
- Robust design
- Various types: e.g. short-long, sterilizable
- Lowest residual imbalance



Ø4–60 mm

EC-max range

- Attractive price/performance ratio
- Robust steel housing
- Speeds up to 20 000 rpm
- Rotor with one pole pair



Ø16–40 mm

EC-4pole range

- Highest power density thanks to 4-pole rotor
- Speeds up to 25 000 rpm
- Mechanical time constants below 3 ms.



Ø22–32 mm

EC flat motor range

- Attractive price/performance ratio
- High torques due to external, multipole rotor
- Excellent heat dissipation at higher speeds, resulting from the to open design
- Speeds of up to 25 000 rpm



Ø9.2–90 mm

EC-i range

- Highly dynamic due to internal, multipole rotor
- Mechanical time constants below 3 ms
- High torque density
- Speeds of up to 15 000 rpm



Ø30–52 mm

EC frameless range

- High torque grace to multi-pole motor design
- Installation instructions with detailed specification for optimum integration.
- Sensor for supervising the temperature (NTC hot conductor)
- Space saving integration

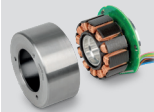

Ø45–90 mm

Electronic commutation

Commutation type

Block commutation

Block-shaped phase currents

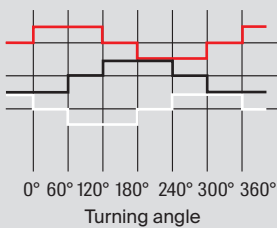

Rotor position determination

with Hall sensors

Signal sequence diagram for the Hall sensors (HS)

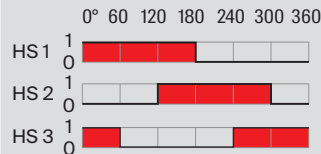

Supplied motor voltage (phase to phase)

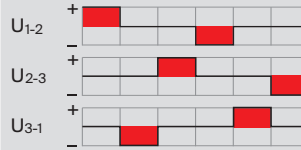

sensorless

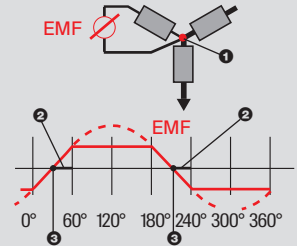

Legend

- ① Star point
- ② Time delay 30°
- ③ Zero crossing of EMF

Sinusoidal commutation

Sinusoidal phase currents

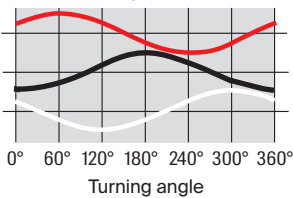

With encoder and Hall sensors (HS)

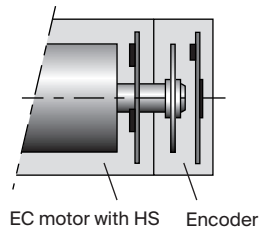

Comparison of DC and EC motors

DC motor (brushed)

- Simple operation and control, even without electronics
- No electronic parts in the motor
- Operating life limited by brush system
- Max. speeds limited by brush system

EC motor (brushless)

- Long operating life and high speeds with preloaded ball bearings
- No commutator arcing
- Iron losses in the magnetic return
- Needs electronics for operation (more cables and higher costs)
- Electronic parts in the motor (Hall sensors)

6.2 Power consideration DC motor

Motor as energy converter

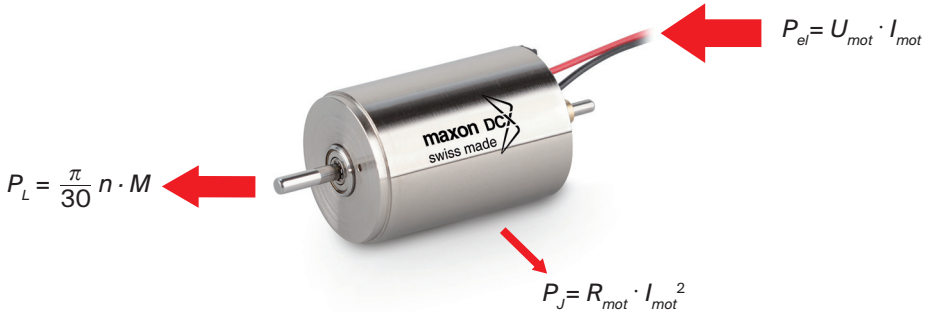

Power balance, motor

$$P_{el} = P_L + P_J$$

$$U_{mot} \cdot I_{mot} = \frac{\pi}{30} \cdot n \cdot M + R_{mot} \cdot I_{mot}^2$$

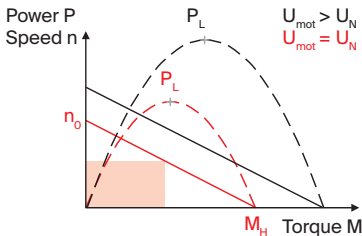

In the speed-torque diagram, the output power is equivalent to the area of the rectangle below the speed-torque line. This rectangle is largest at half the stall torque and half the no-load speed. The power curve is a parabola, whose maximum value is proportional to the square of the motor voltage.

Symbol	Name	SI	Symbol	Name	SI
I_{mot}	Motor current	A	R_{mot}	Terminal resistance, motor (catalog value)	Ω
M	Torque	Nm	U_{mot}	Motor voltage	V
M_H	Stall torque	Nm	U_N	Nominal voltage, motor (catalog value)	V
P	Power	W			
P_{el}	Electrical input power	W			
P_J	Joule power loss	W	Symbol	Name	maxon
P_L	Mechanical output power	W	n	Speed of rotation	rpm
			n_0	No load speed	rpm

6.3 Motor constants and diagrams

Motor constants

The **speed constant** k_n and the **torque constant** k_M are two important characteristic values for the energy conversion.

Speed constant k_n

The speed constant k_n combines the speed n with the voltage induced in the winding $U_{ind}(=EMF)$.

$$n = k_n \cdot U_{ind}$$

Torque constant k_M

The torque constant k_M links the produced torque M with the electrical current I .

$$M = k_M \cdot I_{mot}$$

Information: maxon unit mNm/A

Dependence between k_n and k_M

$$k_n \cdot k_M = \frac{30\,000}{\pi} \left[\frac{\text{rpm}}{\text{V}} \cdot \frac{\text{mNm}}{\text{A}} \right]$$

$$= 1 \left[\frac{\text{rad}}{\text{s} \cdot \text{V}} \cdot \frac{\text{Nm}}{\text{A}} \right]$$

Speed-torque line

Describes the motor behavior – i.e. possible operating points (n , M) – at a constant voltage U_{mot}

$$n_0 \approx k_n \cdot U_{mot}$$

$$M_H = k_M \cdot I_A$$

$$M_R = k_M \cdot I_0$$

$$n = k_n \cdot U_{mot} - \frac{\Delta n}{\Delta M} \cdot M$$

(maxon units)

Speed / torque gradient:

$$\frac{\Delta n}{\Delta M} = \frac{30\,000}{\pi} \cdot \frac{R_{mot}}{k_M^2} \approx \frac{n_0}{M_H}$$

(maxon units)

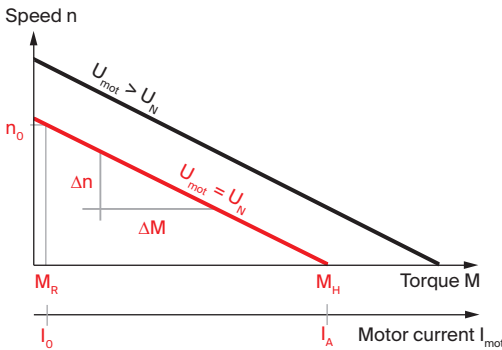

Symbol	Name	SI	Symbol	Name	SI
I_{mot}	Motor current	A	U_{mot}	Motor voltage	V
I_A	Starting current	A	U_N	Nominal voltage, motor (catalog value)	V
I_0	No load current	A			
k_M	Torque constant (catalog value)	Nm/A	Symbol	Name	maxon
M	Torque	Nm	k_n	Speed constant (catalog value)	rpm/V
M_H	Stall torque	Nm	n	Speed of rotation	rpm
M_R	Friction torque	Nm	n_0	No load speed	rpm
R_{mot}	Terminal resistance, motor (catalog value)	Ω	$\Delta n / \Delta M$	Speed / torque gradient, motor (catalog value)	rpm/mNm
U_{ind}	Induced voltage	V			

Voltage equation, motor

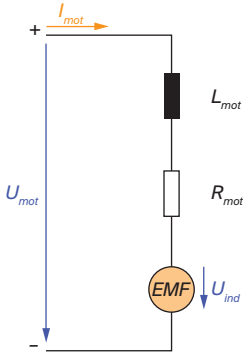

$$U_{mot} = L_{mot} \cdot \frac{di}{dt} + R_{mot} \cdot i_{mot} + U_{ind} \cong R_{mot} \cdot I_{mot} + U_{ind}$$

(at slow current change)

Derived from this the speed of rotation as a function of the load (speed-torque line)

$$n = k_n \cdot U_{mot} - \frac{\Delta n}{\Delta M} \cdot M = n_0 - \frac{\Delta n}{\Delta M} \cdot M$$

(maxon units)

Efficiency curve in function of the torque

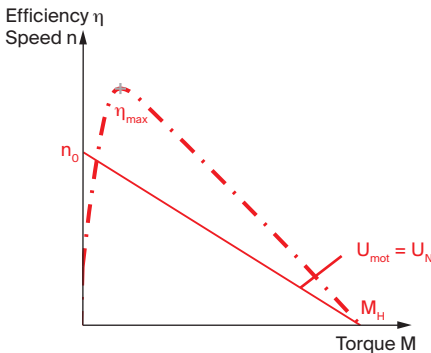

$$\eta = \frac{\pi}{30\,000} \cdot \frac{n \cdot (M - M_R)}{U_{mot} \cdot I_{mot}} \quad (\text{with } M_R = k_M \cdot I_0)$$

$$\eta_{max} = \left(1 - \sqrt{\frac{I_0}{I_A}}\right)^2$$

Symbol	Name	SI	Symbol	Name	SI
EMF	Electromotive force	V	U_{mot}	Motor voltage	V
I_0	No load current	A	di	Current change	A
I_A	Starting current	A	dt	Time change	s
I_{mot}, i_{mot}	Motor current	A	η	Efficiency	
k_M	Torque constant (catalog value)	Nm/A	η_{max}	Maximum efficiency at U_N (catalog value)	
L_{mot}	Terminal inductance, motor (catalog value)	H	Symbol	Name	maxon
M	Torque	Nm	k_n	Speed constant (catalog value)	rpm/V
M_H	Stall torque	Nm	n	Speed of rotation	rpm
M_R	Friction torque	Nm	n_0	No load speed	rpm
R_{mot}	Terminal resistance, motor (catalog value)	Ω	$\Delta n / \Delta M$	Speed / torque gradient, motor (catalog value)	rpm/mNm
U_N	Nominal voltage, motor (catalog value)	V			
U_{ind}	Induced voltage	V			

6.4 Acceleration

Angular acceleration: Start with constant current

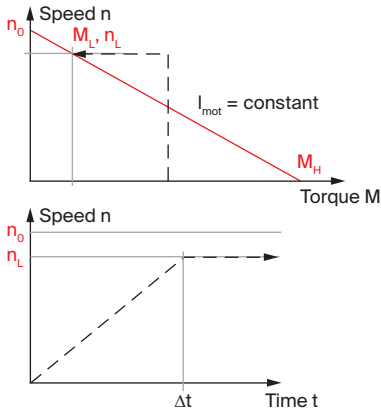

Acceleration

$$\alpha = \frac{M}{J_R + J_L} = \frac{k_M \cdot I_{mot}}{J_R + J_L}$$

Ramp time to load speed

$$\Delta t = \frac{\pi}{30} \cdot n_L \cdot \frac{J_R + J_L}{M} = \frac{\pi}{30} \cdot n_L \cdot \frac{J_R + J_L}{k_M \cdot I_{mot}}$$

Angular acceleration: Start with constant terminal voltage

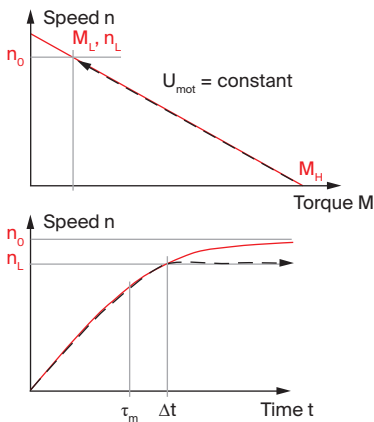

Acceleration, maximum

$$\alpha_{max} = \frac{M_H}{J_R + J_L}$$

Ramp time to load speed

$$\Delta t = \tau_m' \cdot \ln \left[\frac{\left(1 - \frac{M_L + M_R}{M_H}\right) \cdot n_0}{\left(1 - \frac{M_L + M_R}{M_H}\right) \cdot n_0 - n_L} \right]$$

Mechanical time constant with load inertia

$$\tau_m' = \frac{(J_R + J_L) \cdot R_{mot}}{k_M^2}$$

Symbol	Name	SI	Symbol	Name	SI
I_{mot}	Motor current	A	α	Angular acceleration	rad/s ²
J_L	Moment of inertia, load	kgm ²	α_{max}	Maximum angular acceleration	rad/s ²
J_R	Moment of inertia, rotor (catalog value)	kgm ²	Δt	Acceleration time	s
k_M	Torque constant (catalog value)	Nm/A	τ_m	Mechanical time constant (catalog value)	s
M	Torque	Nm	τ_m'	Mechanical time constant with additional J_L	s
M_H	Stall torque	Nm	Symbol	Name	maxon
M_L	Load torque	Nm	n	Speed of rotation	rpm
M_R	Friction torque	Nm	n_0	No load speed	rpm
R_{mot}	Terminal resistance, motor (catalog value)	Ω	n_L	Load speed	rpm
t	Time	s			
U_{mot}	Motor voltage	V			

6.5 Motor selection

Motor type selection

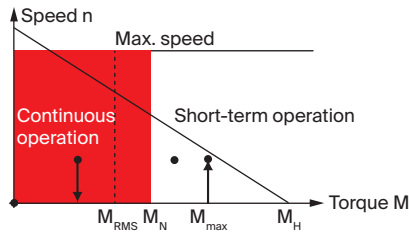

Motor type selection based on the required torques

$$M_N > M_{RMS}$$

$$M_H > M_{max}$$

Root mean square load (RMS)

$$M_{RMS} = \sqrt{\frac{1}{t_{tot}} (t_1 \cdot M_1^2 + t_2 \cdot M_2^2 + \dots + t_n \cdot M_n^2)}$$

Remark:

A motor type (e.g. DCX 32 L) is defined by: its size, the mechanical output power, the bearing system of the shaft, the commutation system used and the possible combinations with gearheads and sensors (maxon modular system)

Winding selection

For an optimum match between the electrical and mechanical power components of the motor.

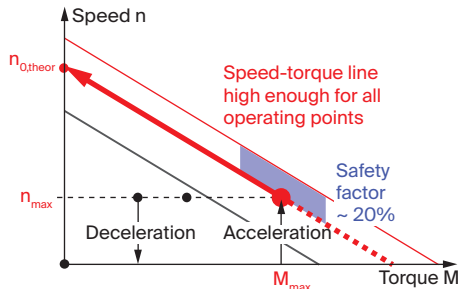

k_n specifies the winding:

Select winding with

$$k_n > k_{n,theor} = \frac{n_{0,theor}}{U_{mot}} = \frac{n_{max} + \frac{\Delta n}{\Delta M} \cdot M_{max}}{U_{mot}}$$

(maxon units)

where n_{max} , M_{max} is the extreme operating point and $\Delta n / \Delta M$ the average speed / torque gradient of the selected motor type.

Recommendation: Add a safety factor of approx. 20% to k_n to compensate for tolerances and load changes; but do not select too large a value for k_n , as this would lead to large currents.

Required maximum motor current

$$I_{mot} = I_0 + \frac{M_{max}}{k_M}$$

Symbol	Name	SI	Symbol	Name	SI
I_{mot}	Motor current	A	$t_{1..n}$	Duration of operating points 1...n	s
I_0	No load current	A	t_{tot}	Total time, operating cycle	s
k_M	Torque constant (catalog value)	Nm/A	Symbol	Name	maxon
$M_{1..n}$	Torque at operating points 1...n	Nm	k_n	Speed constant (catalog value)	rpm/V
M	Torque	Nm	$k_{n,theor}$	Required speed constant	rpm/V
M_H	Stall torque	Nm	n	Speed of rotation	rpm
M_N	Nominal torque, motor (catalog value)	Nm	n_{max}	Maximum speed in load cycle	rpm
M_{RMS}	RMS torque	Nm	$n_{0,theor}$	Required no load speed	rpm
M_{max}	Maximum torque in load cycle	Nm	$\Delta n / \Delta M$	Speed / torque gradient, motor (catalog value)	rpm/mNm
n	Speed of rotation	rpm			
U_{mot}	Motor voltage	V			

7. maxon sensor

maxon incremental encoder

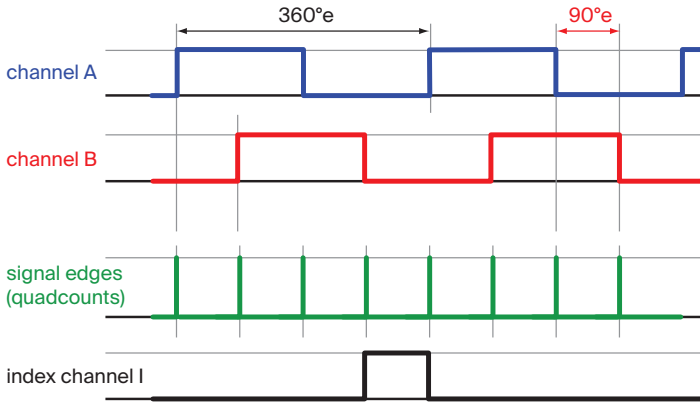

Recommended applications

Principle	magnetic				inductive	optical		
	MR	EASY	QUAD	MEnc	MILE	HEDS, HEDL, AEDL	RIO	ENC22
High number of counts	✓	✓	✗	✗	✓	✓	✓	✓
High speeds	✓	✓	✓	✓	✓	✗	✓	✗
Low speeds	✓	✓	✗	✗	✓	✓	✓	✓
Line driver (in the case of long cables, rough ambient conditions, positioning applications)	✓	✓	✗	✗	✓	✓, ✗	✓	✗
Low positioning accuracy or positioning with gearhead	✓	✓	✗, ✓	✓	✓	✓	✓	✓
High positioning accuracy	✗, ✓	✓	✗	✗	✓	✓	✓	✓
Index channel (for precision homing)	✓	✓	✗	✗	✗	✓	✓	✗
Dust, dirt, oil	✓	✓	✓	✓	✓	✗	✓	✗
Ionizing radiation	✗	✗	(✓)	(✓)	✗	✗	✗	✗
External magnetic fields	✗	(✓)	✗	✗	✓	✓	✓	✓
Mechanically robust	✗	✓	✓	✗	✓	✗	✓	✗

✓ Recommended ✓ With restrictions (✓) Optional (on request) ✗ Not recommended

Counts per turn from position resolution

Required counts per turn N of the encoder for a specified position resolution of $\Delta\varphi$ on the output of a backlash free mechanical drive.

$$N \geq \frac{360^\circ}{\Delta\varphi \cdot i}$$

Remark: By evaluating the quadcounts (qc), a four times finer resolution is achieved. This is recommended for a sufficiently accurate positioning.

Measurement resolution, motor speed

Example:

Measurement resolution ΔQ : (given by the sample rate of the speed controller) 1 qc/ms
 Counts per turn N , encoder: 500 CPT

$$\Delta n = \frac{\Delta Q}{Q \cdot N}$$

$$\Delta n = \frac{\Delta Q}{Q \cdot N} = \frac{1 \frac{qc}{ms}}{4 \frac{qc}{CPT} \cdot 500 CPT} = \frac{60\,000 \frac{qc}{min}}{2000 qc} = 30 \text{ rpm}$$

Comment: The achievable speed stability is much higher than the above measurement resolution, due to the mass inertias and feed forward (if applicable).

Symbol	Name	SI	Symbol	Name	SI
N	Counts per turn	CPT	$\Delta\varphi$	Position resolution	$^\circ$
i	Reduction ratio, mechanical drive				
$Q = 4$	Quadcounts per pulse	qc/IMP	Symbol	Name	maxon
ΔQ	Measurement resolution	qc/ms	Δn	Measurement resolution, motor speed	rpm

8. maxon controller

8.1 Operating quadrants

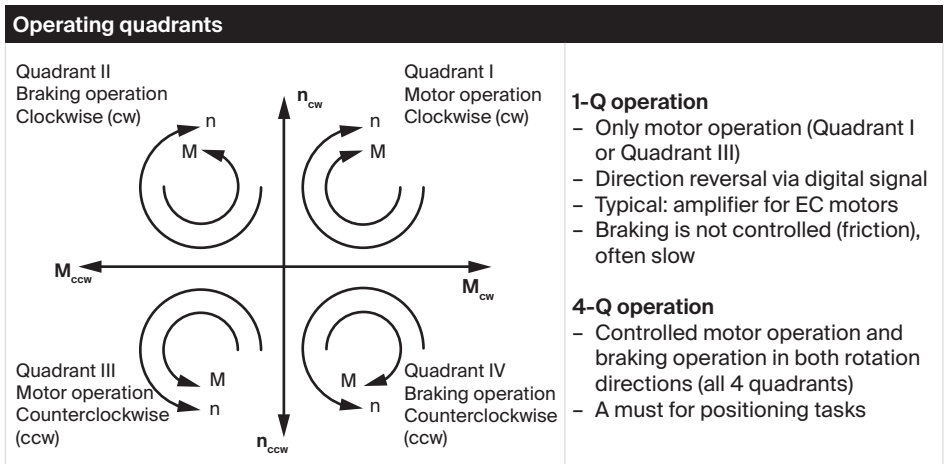

8.2 Selection of power supply

Required supply voltage at given load (n_L, M_L)

$$V_{CC} \geq \frac{U_N}{n_{0,UN}} \cdot \left(n_L + \frac{\Delta n}{\Delta M} \cdot M_L \right) + \Delta U_{max} \quad (\text{maxon units})$$

Notes:

- In the case of a 4Q servo amplifier, the power supply has to be able to absorb the kinetic energy generated (for example in a capacitor) when the load is decelerated.
- When a stabilized power supply is used, the overcurrent protection has to be deactivated for the operating range.
- The formula includes the maximum voltage drop ΔU_{max} of the controller at maximum continuous current.

Achievable speed at given voltage supply

$$n_L \leq \left[(V_{CC} - \Delta U_{max}) \cdot \frac{n_{0,UN}}{U_N} \right] - \left[\frac{\Delta n}{\Delta M} \cdot M_L \right] \quad (\text{maxon units})$$

Symbol	Name	SI	Symbol	Name	maxon
M	Torque	Nm	n	Speed of rotation	rpm
M_L	Load torque	Nm	n_L	Load speed	rpm
U_N	Nominal voltage, motor (catalog value)	V	$n_{0,UN}$	No load speed motor at U_N (catalog value)	rpm
V_{CC}	Supply voltage	V	$\Delta n / \Delta M$	Speed / torque gradient, motor (catalog value)	rpm/mNm
ΔU_{max}	Maximum voltage drop of the controller	V			

8.3 Size of the motor choke with PWM controllers

Calculation of current ripple

PWM scheme	1-Q	2-level (4-Q)	3-level (4-Q)
Maximum current ripple, peak-to-peak	$\Delta I_{PP,max} = \frac{V_{CC}}{4 \cdot L_{tot} \cdot f_{PWM}}$	$\Delta I_{PP,max} = \frac{V_{CC}}{2 \cdot L_{tot} \cdot f_{PWM}}$	$\Delta I_{PP,max} = \frac{V_{CC}}{4 \cdot L_{tot} \cdot f_{PWM}}$
Calculation L_{tot}	$L_{tot} = L_{int} + 0.3...0.8 \cdot L_{mot} + L_{ext}$		

The effective motor inductance in the case of square PWM excitation only amounts to approx. 30–80% of the catalog value L_{mot} .
The catalog value L_{mot} is defined at a frequency of 1 kHz with sinusoidal excitation.

- At a current ripple of $\Delta I_{pp} \leq 1.5 \cdot I_N$ the motor can still be loaded to approx. 90% of the nominal current I_N (catalog value).
- At a current ripple of $\Delta I_{pp} > 1.5 \cdot I_N$, it is recommended to use an external motor choke, in accordance with the formula below.

Calculation, additional external motor choke

PWM scheme	1-Q and 3-level (4-Q)	2-level (4-Q)
Rule of thumb	$L_{ext} = \frac{V_{CC}}{6 \cdot I_N \cdot f_{PWM}} - L_{int} - 0.3 \cdot L_{mot}$	$L_{ext} = \frac{V_{CC}}{3 \cdot I_N \cdot f_{PWM}} - L_{int} - 0.3 \cdot L_{mot}$

- $L_{ext} \leq 0$ No additional motor choke required
 $L_{ext} > 0$ Additional motor choke recommended

DC amplifier

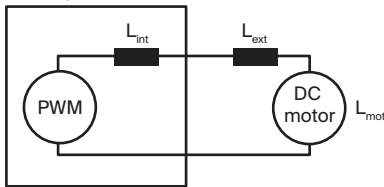

EC amplifier

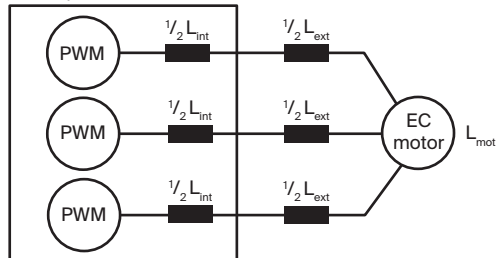

Symbol	Name	SI	Symbol	Name	SI
f_{PWM}	PWM frequency	Hz	L_{mot}	Terminal inductance, motor (catalog value)	H
I_N	Nominal current, motor (catalog value)	A	L_{tot}	Total inductance	H
L_{ext}	Inductance, additional external motor choke	A	V_{CC}	Supply voltage	V
L_{int}	Inductance, built-in choke controller	H	ΔI_{pp}	Current ripple, peak-to-peak	A
		H	$\Delta I_{pp,max}$	Maximum current ripple, peak-to-peak	A

9. Thermal behavior

9.1 Basics

Heat sources					
Iron losses in EC motors and motors with iron core winding	Remagnetization losses $P_{V,magn} = \frac{\pi}{30} \cdot n \cdot M_{magn}$	Eddy current losses $P_{V,eddy} = const \cdot n^2$			
Joule power losses in winding		$P_J = R_{TW} \cdot I_{mot}^2$ $R_{TW} = R_{mot} \cdot [1 + \alpha_{Cu} \cdot (T_W - 25^\circ\text{C})]$			
Friction losses: in the bearings and in the brushes (brushed DC motors)					
Losses in the gearhead		$P_{V,R} = \frac{\pi}{30} \cdot n_{mot} \cdot M_{mot} \cdot (1 - \eta_G)$ $P_{V,R} = \frac{\pi}{30} \cdot n_L \cdot M_L \cdot \frac{1 - \eta_G}{\eta_G}$			
Stall torque reduced through temperature rise					
First approximation; calculated from voltage and increased winding resistance (Temperature dependence of k_M not considered)		$M_{HT} = k_M \cdot I_{AT} = k_M \cdot \frac{U_{mot}}{R_{TW}}$			
Storing heat					
$Q = c \cdot m \cdot \Delta T = C_{th} \cdot \Delta T$		$Q = P_V \cdot t$			
Winding: $C_{th,W} = c_{Cu} \cdot m_W$		Stator: $C_{th,S} = c_{Fe} \cdot m_{mot}$			
Gearhead: $C_{th,G} = c_{Fe} \cdot m_G$					
Symbol	Name	SI	Symbol	Name	SI
C_{th}	Heat capacity	J/K	$P_{V,magn}$	Power losses for reversal of magnetization	W
$C_{th,G}$	Heat capacity gearhead	J/K	$P_{V,R}$	Friction power losses	W
$C_{th,S}$	Heat capacity stator	J/K	Q	Stored heat	J
$C_{th,W}$	Heat capacity winding	J/K	R_{mot}	Terminal resistance, motor (catalog value)	Ω
c	Specific heat capacity	J/(kgK)	R_{TW}	Winding resistance at current temp. T_W	Ω
I_{AT}	Starting current at temperature T_W	A	T	Temperature	$^\circ\text{C}$
I_{mot}	Motor current	A	T_W	Winding temperature	$^\circ\text{C}$
k_M	Torque constant (catalog value)	Nm/A	t	Time	s
M	Torque	Nm	U_{mot}	Motor voltage	V
$M_{G,cont}$	Maximum continuous torque, gearhead (catalog value)	Nm	ΔT	Temperature difference	K
M_{HT}	Stall torque at temperature T_W	Nm	η	Efficiency	
M_L	Load torque	Nm	η_G	Gearhead efficiency	
M_{magn}	Torque for reversal of magnetization	Nm	Symbol	Name	maxon
M_{mot}	Motor torque	Nm	n	Speed of rotation	rpm
m	Mass	kg	n_L	Load speed	rpm
m_G	Mass, gearhead	kg	n_{mot}	Motor speed	rpm
m_{mot}	Mass, motor	kg	Symbol	Name	Value
m_W	Mass, winding	kg	α_{Cu}	Resistance coefficient, copper	0.0039 K ⁻¹
P_J	Joule power losses	W	c_{Cu}	Specific heat capacity copper	380 J/(kgK)
P_V	Power losses	W	c_{Fe}	Specific heat capacity iron	450 – 470 J/(kgK)
$P_{V,eddy}$	Eddy current power losses	W			

Analogy to electrical circuit:

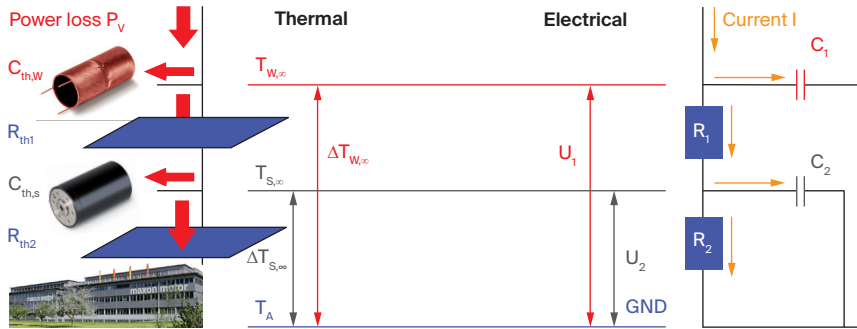

Thermal → Heat flow

Losses

Symbol	Name	Unit
Q	Stored heat	J
P_V	Power losses	W = J/s
$\Delta T_{W,\infty}$	Temperature difference, winding-ambient	K
$\Delta T_{S,\infty}$	Temperature difference, stator-ambient	K
T_A	Ambient temperature	°C (K)
R_{th1}	Therm. resistance, winding-housing (catalog value)	K/W
R_{th2}	Therm. resistance, housing-ambient (catalog value)	K/W
$C_{th,W}$	Heat capacity, winding	J/K
$C_{th,S}$	Heat capacity, stator	J/K

Electrical → Current flow

Current source

Symbol	Name	Unit
Q	Electric charge	C
I	Current	A = C/s
U_1	Voltage, potential difference	V
U_2	Voltage, potential difference	V
GND	Ground	V
R_1	Electrical resistance	Ω
R_2	Electrical resistance	Ω
C_1	Electrical capacitance	F
C_2	Electrical capacitance	F

Heating of a simple body

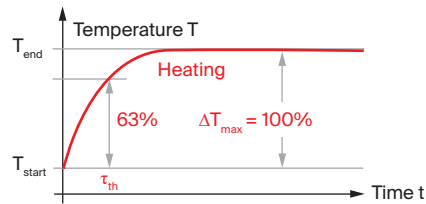

$$\Delta T(t) = \Delta T_{max} \cdot \left[1 - e^{-\frac{t}{\tau_{th}}} \right]$$

Cooling of a simple body

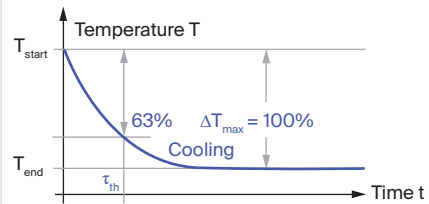

$$\Delta T(t) = \Delta T_{max} \cdot e^{-\frac{t}{\tau_{th}}}$$

Symbol	Name	SI
T	Temperature	°C
T_A	Ambient Temperature	°C
T_{end}	End temperature	°C
T_{start}	Temperature at start	°C
$T_{S,\infty}$	End temperature, stator	°C
$T_{W,\infty}$	End temperature, winding	°C

Symbol	Name	SI
t	Time	s
ΔT_{max}	Maximum temperature change	K
$\Delta T(t)$	Temperature change as a function of time t	K
τ_{th}	Thermal time constant	s

9.2 Continuous operation

Continuous operation is characterized by a thermal equilibrium. After several motor time constants the temperature difference between the rotor and stator stays constant, as their temperatures do not increase further.

Motor: Winding and stator temperature

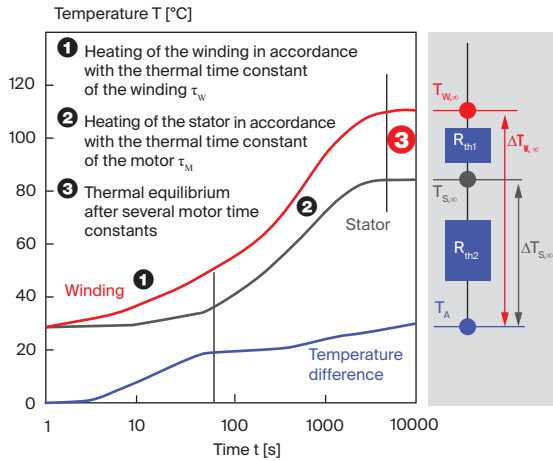

$$\Delta T_{W,\infty} = T_{W,\infty} - T_A = (R_{th1} + R_{th2}) \cdot P_J$$

$$\Delta T_{W,\infty} = \frac{(R_{th1} + R_{th2}) \cdot R_{TA} \cdot I_{mot}^2}{1 - \alpha_{Cu} \cdot (R_{th1} + R_{th2}) \cdot R_{TA} \cdot I_{mot}^2}$$

$$\Delta T_{S,\infty} = T_{S,\infty} - T_A = \frac{R_{th2}}{R_{th1} + R_{th2}} \Delta T_{W,\infty}$$

Gearhead: Housing temperature

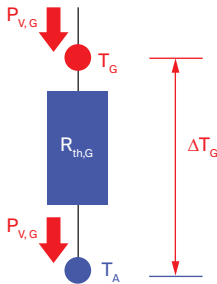

$$\Delta T_G = T_G - T_A = R_{th,G} \cdot P_{v,G}$$

$R_{th,G}$: e.g. estimated with R_{th2} of motors with the same size

Symbol	Name	SI	Symbol	Name	SI
I_{mot}	Motor current	A	$T_{S,\infty}$	End temperature, stator	°C
P_J	Joule power losses	W	$T_{W,\infty}$	End temperature, winding	°C
$P_{v,G}$	Power losses, gearhead	W	t	Time	s
R_{TA}	Winding resistance at temperature T_A	Ω	ΔT_G	Temperature difference, gearhead–ambient	K
$R_{th,G}$	Therm. resistance, gearhead–ambient	K/W	$\Delta T_{S,\infty}$	Temperature difference, stator–ambient	K
R_{th1}	Therm. resistance, winding–housing (catalog value)	K/W	$\Delta T_{W,\infty}$	Temperature difference, winding–ambient	K
R_{th2}	Therm. resistance, housing–ambient (catalog value)	K/W	τ_M	Therm. time constant, motor (catalog value)	s
T	Temperature	°C	τ_w	Therm. time constant, winding (catalog value)	s
T_A	Ambient temperature	°C			
T_G	Gearhead temperature	°C	Symbol	Name	Value
			α_{Cu}	Resistance coefficient, copper	0.0039 K ⁻¹

Permissible nominal current I_N

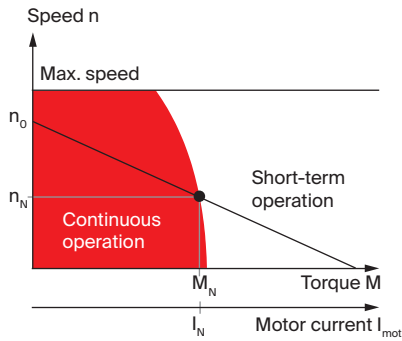

Dependency on ambient temperature under standard mounting conditions (free air convection at 25°C; mounted horizontally on plastic plate)

$$I_{N,TA} = I_N \cdot \sqrt{\frac{T_{max} - T_A}{T_{max} - 25^\circ\text{C}}}$$

Temperature-dependence under modified mounting conditions

$$I_{N,TA} = I_N \cdot \sqrt{\frac{T_{max} - T_A}{T_{max} - 25^\circ\text{C}} \cdot \frac{R_{th1} + R_{th2}}{R_{th1} + R_{th2,mod}}}$$

Determining $R_{th2,mod}$

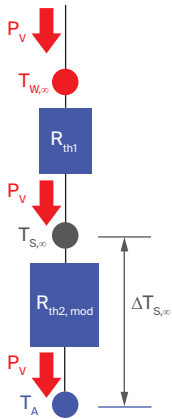

Motor under original conditions

- Installation, fastening, air circulation

Separate measurement in continuous operation

- Stator temperature $T_{S,\infty}$
- Ambient temperature T_A

$$R_{th2,mod} = \Delta T_{S,\infty} \cdot \frac{1 - \alpha_{Cu} \cdot R_{th1} \cdot R_{TA} \cdot I_{mot}^2}{R_{TA} \cdot I_{mot}^2 \cdot (1 + \alpha_{Cu} \cdot \Delta T_{S,\infty})}$$

Symbol	Name	SI	Symbol	Name	SI
I_{mot}	Motor current	A	T_{max}	Max. winding temperature (catalog value)	°C
I_N	Nominal current, motor (catalog value)	A	$T_{S,\infty}$	End temperature, stator	°C
$I_{N,TA}$	Nominal current as a function of T_A	A	$T_{W,\infty}$	End temperature, winding	°C
M	Torque	Nm	$\Delta T_{S,\infty}$	Temperature difference, stator-ambient	K
M_N	Nominal torque, motor (catalog value)	Nm			
P_V	Power losses	W			
R_{TA}	Winding resistance at temperature T_A	Ω	Symbol	Name	maxon
R_{th1}	Therm. resistance, winding-housing (catalog value)	K/W	n	Speed of rotation	rpm
R_{th2}	Therm. resistance, housing-ambient (catalog value)	K/W	n_N	Nominal speed, motor (catalog value)	rpm
$R_{th2,mod}$	Therm. resistance, housing-ambient modified	K/W	n_0	No load speed	rpm
T_A	Ambient temperature	°C	Symbol	Name	Value
			α_{Cu}	Resistance coefficient, copper	0.0039 K ⁻¹

9.3 Cyclic and intermittent operation (continuously repeated)

Repetitive work cycles of short duration (typically only a few seconds) can be assessed with the same formalism as continuous operation.

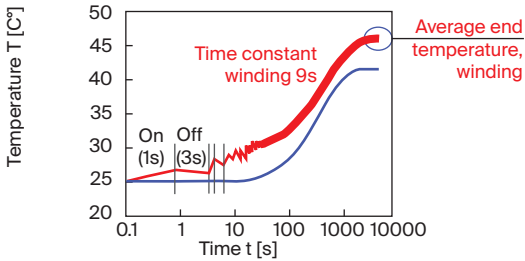

Average temperature rise during intermittent operation

Use effective current value (RMS) as motor load.

$$\Delta T_{W,\infty} = \frac{(R_{th1} + R_{th2}) \cdot R_{TA} \cdot I_{RMS}^2}{1 - \alpha_{Cu} (R_{th1} + R_{th2}) \cdot R_{TA} \cdot I_{RMS}^2}$$

$$\Delta T_{S,\infty} = \frac{R_{th2}}{(R_{th1} + R_{th2})} \Delta T_{W,\infty}$$

Intermittent operation

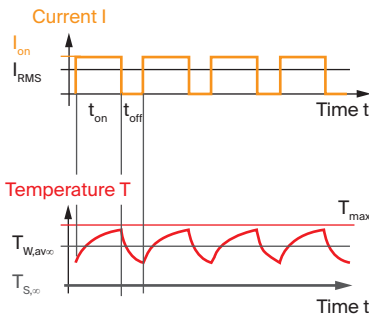

RMS current

$$I_{RMS} = I_{on} \cdot \sqrt{\frac{t_{on}}{t_{on} + t_{off}}}$$

Basic requirement: $I_{RMS} \leq I_{N,TA}$

Maximum load current for a given time cycle

$$I_{on} \leq I_N \cdot \sqrt{\frac{T_{max} - T_A}{T_{max} - 25^\circ\text{C}} \cdot \frac{t_{on} + t_{off}}{t_{on}}}$$

OFF duration for a load of I_{on} during t_{on}

$$t_{off} \geq \left[\frac{I_{on}^2}{I_N^2 \cdot \frac{T_{max} - T_A}{T_{max} - 25^\circ\text{C}}} - 1 \right] \cdot t_{on}$$

Symbol	Name	SI	Symbol	Name	SI
I	Current	A	T_{max}	Max. winding temperature (catalog value)	°C
I_N	Nominal current, motor (catalog value)	A	$T_{S,\infty}$	End temperature, stator	°C
$I_{N,TA}$	Nominal current as a function of T_A	A	$T_{W,av\infty}$	Average end temperature, winding	°C
I_{on}	Current during ON phase	A	t	Time	s
I_{RMS}	RMS current	A	t_{off}	OFF time	s
R_{TA}	Winding resistance at temperature T_A	Ω	t_{on}	ON time	s
R_{th1}	Therm. resistance, winding–housing (catalog value)	K/W	$\Delta T_{S,\infty}$	Temperature difference, stator–ambient	K
R_{th2}	Therm. resistance, housing–ambient (catalog value)	K/W	$\Delta T_{W,\infty}$	Temperature difference, winding–ambient	K
T	Temperature	°C	Symbol	Name	Value
T_A	Ambient temperature	°C	α_{Cu}	Resistance coefficient, copper	0.0039 K ⁻¹

9.4 Short-term operation

High, brief, one-time overload of the motor. The operation duration is so short that the temperature of the thermally inert stator does not increase significantly; this corresponds to an ON time of approx. $\tau_M / 10 (\approx 5 \cdot \tau_W)$.

→ Only the heating of the winding, which corresponds to the heating of a simple body (see chapter 9.1), has to be taken into account.

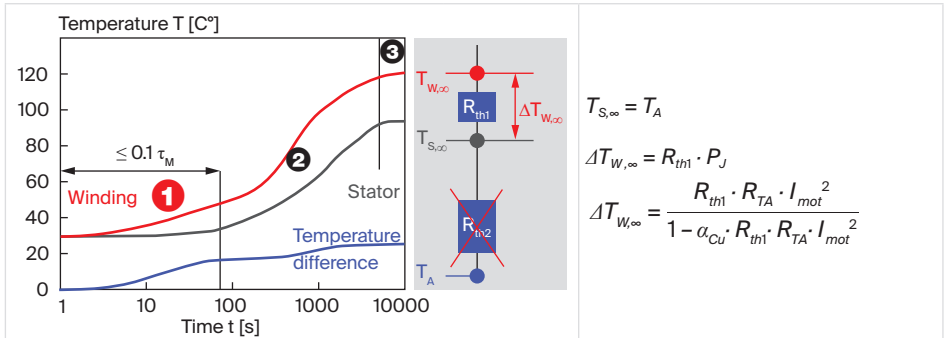

$$T_{S,\infty} = T_A$$

$$\Delta T_{W,\infty} = R_{th1} \cdot P_J$$

$$\Delta T_{W,\infty} = \frac{R_{th1} \cdot R_{TA} \cdot I_{mot}^2}{1 - \alpha_{Cu} \cdot R_{th1} \cdot R_{TA} \cdot I_{mot}^2}$$

Overload factor K

Quantification of the overload

Meaning:

- $K < 1$: T_{max} is not reached during short-term operation
- $K > 1$: Limit maximum ON time t_{on}

$$K = \frac{I_{mot}}{I_N} \cdot \sqrt{\frac{T_{max} - 25^\circ\text{C}}{T_{max} - T_{S,\infty}}} \cdot \frac{R_{th1}}{R_{th1} + R_{th2}}$$

Maximum permissible overload at given ON time t_{on}

$$K = \sqrt{\frac{1}{1 - \exp\left[-\frac{t_{on}}{\tau_W}\right]}}$$

Maximum ON time t_{on} at given overload factor K

$$t_{on} = \tau_W \cdot \ln \frac{K^2}{K^2 - 1}$$

Maximum motor current I_{mot} at given overload factor K

$$I_{mot} = K \cdot I_N \cdot \sqrt{\frac{T_{max} - T_S}{T_{max} - 25^\circ\text{C}}} \cdot \frac{R_{th1} + R_{th2}}{R_{th1}}$$

Symbol	Name	SI	Symbol	Name	SI
I_{mot}	Motor current	A	$T_{S,\infty}$	End temperature, stator	°C
I_N	Nominal current, motor (catalog value)	A	$T_{W,\infty}$	End temperature, winding	°C
K	Overload factor		t	Time	s
P_J	Joule power losses	W	t_{on}	ON time	s
R_{TA}	Winding resistance at temperature T_A	Ω	$\Delta T_{W,\infty}$	Temperature difference, winding-ambient	K
R_{th1}	Therm. resistance, winding-housing (catalog value)	K/W	τ_M	Therm. time constant, motor (catalog value)	s
R_{th2}	Therm. resistance, housing-ambient (catalog value)	K/W	τ_W	Therm. time constant, winding (catalog value)	s
T	Temperature	°C			
T_A	Ambient temperature	°C	Symbol	Name	Value
T_{max}	Max. winding temperature (catalog value)	°C	α_{Cu}	Resistance coefficient, copper	0.0039 K ⁻¹

10. Tables

10.1 maxon Conversion Tables

General Information		
Quantities and their basic units in the International System of Units (SI)		
Quantity	Base unit	Unit sign
Length	Meter	m
Mass	Kilogram	kg
Time	Second	s
Electric current	Ampere	A
Thermodynamic temperature	Kelvin	K
Conversion example		
A Known unit		
B Unit sought		
Known: oz-in	Multiply by 7.06	ought: mNm

Factors used for ...

... conversions:

1 oz = 2.834952313 · 10⁻² kg
 1 in = 2.54 · 10⁻² m

... gravitational acceleration:

g = 9.80665 m s⁻²
 = 386.08858 in s⁻²

... derived units:

1 yd = 3 ft = 36 in
 1 lb = 16 oz = 7000 gr (grains)
 1 kp = 1 kg · 9.80665 ms⁻²
 1 N = 1 kgms⁻²
 1 W = 1 Nms⁻¹ = 1 kgm²s⁻³
 1 J = 1 Nms⁻¹ = 1 Ws

Decimal multiples and fractions of units

Prefix	Abbreviation	Power of ten	Prefix	Abbreviation	Power of ten
deca..	da	10 ¹	deci..	d	10 ⁻¹
hecto..	h	10 ²	centi..	c	10 ⁻²
kilo..	k	10 ³	milli..	m	10 ⁻³
mega..	M	10 ⁶	micro..	μ	10 ⁻⁶
giga..	G	10 ⁹	nano..	n	10 ⁻⁹
tera..	T	10 ¹²	pico..	p	10 ⁻¹²

Power								P [W]
B \ A	oz-in-s ⁻¹	oz-in-rpm	in-lbf-s ⁻¹	ft-lbf-s ⁻¹	Nms ⁻¹ =W	mW	kpm s ⁻¹	mNm/rpm
W=Nm s ⁻¹	7.06 · 10 ⁻³	1.17 · 10 ⁻⁴	0.113	1.356	–	1 · 10 ⁻³	9.807	1/9000
mW	7.06	0.117	112.9	1.356 · 10 ³	1 · 10 ³	–	9.807 · 10 ³	1/60
oz-in-s ⁻¹	–	1/60	16	192	141.6	0.142	1.39 · 10 ³	2.36 · 10 ⁻³
ft-lbf-s ⁻¹	1/192	1/1520	1/12	–	0.737	0.737 · 10 ⁻³	7.233	1.23 · 10 ⁻⁵
kpm s ⁻¹	7.20 · 10 ⁻⁴	1.2 · 10 ⁻⁵	1.15 · 10 ⁻²	0.138	0.102	0.102 · 10 ⁻³	–	1.70 · 10 ⁻⁸

Torque								M [Nm]
B \ A	oz-in	ft-lbf	Nm = Ws	Ncm	mNm	kpm	pcm	
Nm = Ws	7.06 · 10 ⁻³	1.356	–	1 · 10 ⁻²	1 · 10 ⁻³	9.807	9.807 · 10 ⁻³	
mNm	7.06	1.356 · 10 ³	1 · 10 ³	10	–	9.807 · 10 ³	9.807 · 10 ²	
kpm	7.20 · 10 ⁻⁴	0.138	0.102	0.102 · 10 ⁻²	0.102 · 10 ⁻³	–	1 · 10 ⁻⁵	
oz-in	–	192	141.6	1.416	0.142	1.39 · 10 ³	1.39 · 10 ⁻²	
ft-lbf	1/192	–	0.737	0.737 · 10 ⁻²	0.737 · 10 ⁻³	7.233	7.233 · 10 ⁻⁵	

Moment of inertia								J [kg m²]
B \ A	oz-in ²	oz-in-s ²	lb-in ²	lb-in-s ²	Nms ² =kgm ²	mNm s ²	gcm ²	kpm s ²
g cm ²	182.9	7.06 · 10 ⁻⁴	2.93 · 10 ³	1.13 · 10 ⁶	1 · 10 ⁻⁷	1 · 10 ⁻⁴	–	9.807 · 10 ⁷
kgm ² =Nms ²	1.83 · 10 ⁻⁵	7.06 · 10 ⁻³	2.93 · 10 ⁻⁴	0.113	–	1 · 10 ⁻³	1 · 10 ⁻⁷	9.807
oz-in ²	–	386.08	16	6.18 · 10 ³	5.46 · 10 ⁴	54.6	5.46 · 10 ⁻³	5.35 · 10 ⁵
lb-in ²	1/16	24.130	–	386.08	3.41 · 10 ³	3.41	3.41 · 10 ⁻⁴	3.35 · 10 ⁴

Mass						Force					
B \ A	oz	lb	gr (grain)	kg	g	B \ A	oz	lbf	N	kp	p
kg	28.35 · 10 ⁻³	0.454	64.79 · 10 ⁻⁶	–	1 · 10 ⁻³	N	0.278	4.448	–	9.807	9.807 · 10 ⁻³
g	28.35	0.454 · 10 ³	64.79 · 10 ⁻³	1 · 10 ³	–	kp	0.028	0.454	0.102	–	1 · 10 ⁻³
oz	–	16	2.26 · 10 ⁻³	35.27	35.27 · 10 ³	oz	–	16	3.600	35.27	35.27 · 10 ⁻³
lb	1/16	–	1/7000	2.205	2.205 · 10 ³	lbf	1/16	–	0.225	2.205	2.205 · 10 ⁻³
gr (grain)	437.5	7000	–	15.43 · 10 ⁻³	15.43 · 10 ⁶	pdll	2.011	32.17	7.233	70.93	70.93 · 10 ⁻³

Length								l [m]
B \ A	in	ft	yd	Mil	m	cm	mm	μm
m	25.4 · 10 ⁻³	0.305	0.914	25.4 · 10 ⁻⁶	–	0.01	1 · 10 ⁻³	1 · 10 ⁻⁶
cm	2.54	30.5	91.4	25.4 · 10 ⁻⁴	1 · 10 ⁻²	–	0.1	1 · 10 ⁻⁴
mm	25.4	305	914	25.4 · 10 ⁻³	1 · 10 ³	10	–	1 · 10 ⁻³
in	–	12	36	1 · 10 ⁻³	39.37	0.394	3.94 · 10 ⁻²	3.94 · 10 ⁻⁵
ft	1/12	–	3	1/12 · 10 ⁻³	3.281	3.281 · 10 ⁻²	3.281 · 10 ⁻³	3.281 · 10 ⁻⁶

Angular velocity				ω [s ⁻¹]	Angular acceleration				α [s ⁻²]
B \ A	s ⁻¹ = Hz	rpm	rad s ⁻¹	B \ A	min ⁻²	s ⁻²	rad s ⁻²	rpm s ⁻²	
rad s ⁻¹	2π	π/30	–	s ⁻²	1/3600	–	1/2π	1/60	
rpm	1/60	–	30/π	rad s ⁻²	π/1800	2π	–	π/30	

Linear velocity								v [m s ⁻¹]
B \ A	in-s ⁻¹	in-rpm	ft-s ⁻¹	ft-rpm	m s ⁻¹	cm s ⁻¹	mm s ⁻¹	m rpm
m s ⁻¹	2.54 · 10 ⁻²	4.23 · 10 ⁻⁴	0.305	5.08 · 10 ⁻³	–	1 · 10 ⁻²	1 · 10 ⁻³	1/60
in-s ⁻¹	–	60	12	720	39.37	39.37 · 10 ⁻²	39.37 · 10 ⁻³	0.656
ft-s ⁻¹	1/12	5	–	60	3.281	3.281 · 10 ⁻²	3.281 · 10 ⁻³	5.46 · 10 ⁻²

Temperature				T [K]
B \ A	° Fahrenheit	° Celsius	Kelvin	
Kelvin	(°F - 305.15)/1.8	°C + 273.15	–	
° Celsius	(°F - 32)/1.8	–	K - 273.15	
° Fahrenheit	–	1.8°C + 32	1.8 K + 305.15	

Units used in the maxon catalog

10.2 Typical coefficients of friction for rolling, static and kinetic friction

Type of friction	Friction condition	Description
Kinetic friction	Solid-to-solid friction (dry kinetic friction)	Direct contact between the friction partners
	Boundary friction (lubricated kinetic friction)	Special case of solid-to-solid friction with adsorbed lubricant on the surfaces
	Mixed friction	Solid-to-solid friction and fluid friction combined next to each other
	Fluid friction	Friction partners are completely separated from each other by a film of fluid (produced hydrostatically or hydrodynamically)
	Gas friction	Friction partners are completely separated from each other by a gas film (produced aerostatically or aerodynamically)
Static friction		20 ... 100% higher than kinetic friction
Rolling friction	Rolling friction	Bodies separated by lubricated roller bearings
	Combined rolling and sliding friction	Rolling friction with a kinetic component (slip)

Typical coefficient of friction	Examples	Coefficient of friction
0.1 ... 1	Sintered bronze – Steel	0.15 ... 0.3
	Plastic – Gray cast iron	0.3 ... 0.4
	Steel – Steel	0.4 ... 0.7
	Nitrided steel – Nitrided steel	0.3 ... 0.4
	Copper – Copper	0.6 ... 1.0
	Chromium – Chromium	0.41
	Al alloy – Al alloy	0.15 ... 0.6
0.1 ... 0.2	Steel – Steel	0.1
0.01 ... 0.1	Sleeve bearing, lubricated, at low speeds of rotation	
	Sintered bronze – Steel	0.05 ... 0.1
	Sintered iron – Steel	0.07 ... 0.1
	Tempered steel – Tempered steel	0.05 ... 0.08
0.001 ... 0.01	Sintered sleeve bearing, lubricated, at high speeds of rotation and low radial load	
0.0001		
0.1 ... 1.2	Steel – Steel dry	0.4 ... 0.8
	Steel – Steel lubricated	0.08 ... 0.12
	Sintered bronze – Steel dry	0.2 ... 0.4
	Sintered bronze – Steel lubricated	0.12 ... 0.14
	Plastic – Gray cast iron, dry	0.3 ... 0.5
0.001 ... 0.005	Ball bearings	0.001 ... 0.0025
0.001 ... 0.1		

11. Symbol list for the Formulae Handbook

Name	Symbol	Unit	Page number
Acceleration	a	m/s ²	9, 14
Acceleration force	F_a	N	9, 24
Acceleration force, 1 st /2 nd half cycle	F_{a1}/F_{a2}	N	24
Acceleration time	Δt_a	s	22, 23, 24, 25
Acceleration time	Δt	s	41
Ambient temperature	T_A	°C	48, 49, 50, 51, 52
Angle of the inclined plane	α	°	9
Angular acceleration	α	rad/s ²	11, 15, 41
Angular frequency	ω	rad/s	33
Angular velocity / Angular velocity (change)	$\omega / \Delta\omega, \Delta\omega / \Delta t\omega$	rad/s	11, 15, 21
Angular velocity after / before acceleration	$\omega_{end} / \omega_{start}$	rad/s	15
Angular velocity, input / load	ω_{in} / ω_L	rad/s	21
Average end temperature, winding	T_{Wav}	°C	51
Bearing load, axial / radial	F_{KL}	N	11
Capacitance	C	F	30, 33, 34
Coefficient of friction (see table chapt. 10.2)	μ		9, 11
Compressive force	F_P	N	9
Counts per turn, CPT	N		44
Cross section	A	m ²	9, 13
Current	I	A	29, 33, 34, 48, 51
Current change	dI	A	40
Current during ON phase	I_{on}	A	51
Current ripple, peak-to-peak	ΔI_{pp}	A	46
Current through resistor R_2	I_{R2}	A	32
Cut-off frequency	f_C	Hz	34
Density	ρ	kg/m ³	12, 13
Diameter, deflector pulley 2	d_2	m	22
Diameter, deflector pulley X	d_X	m	22
Diameter, drive pulley	d_1	m	22, 25
Diameter, drive wheel	d	m	23
Diameter, load pulley	d_2	m	25
Displacement	Δl	m	9
Distance change	Δs	m	14, 16, 17
Distance of axis s from center of gravity S	r_s	m	13
Downhill-slope force	F_H	N	9
Drop height	h	m	14
Duration	Δt	s	9, 11
Duration of operating points 1...n	$t_{1..n}$	s	42
Eccentricity	e	m	24
Eddy current power losses	P_{eddy}	W	47
Efficiency	η		21, 22, 23, 24, 25, 40, 47
Electric charge	Q	C	48
Electrical capacitance	C_e / C_2	F	48
Electrical input power	P_{in}	W	38
Electrical resistance	$R / R_1 / R_2$	Ω	29, 30, 33, 34, 48
Electrical time constant	τ_{el}	s	30
Electromotive force	EMK	V	40
End temperature	T_{end}	°C	48
End temperature, stator / winding	T_{S-} / T_{W-}	°C	48, 49, 50, 51, 52
Equivalent resistance	R	Ω	31, 32
Equivalent resistance of R_2 and R_L	R_e	Ω	32
Force	F	N	9, 11, 21
Frequency	f	Hz	33, 34
Friction force	F_R	N	9
Friction power losses	P_{fR}	W	47
Friction torque	M_R	Nm	11, 39, 40, 41
Gearhead efficiency	η_G		47
Gearhead temperature	T_G	°C	49
Gravitational acceleration	g	m/s ²	9, 14
Ground	GND	V	48
Heat capacity	C_{th}	J/K	47
Heat capacity gearhead / stator / winding	$C_{thG} / C_{thS} / C_{thW}$	J/K	47, 48
Height	h	m	12, 13
Impedance	Z	Ω	33
Induced voltage	U_{ind}	V	39, 40
Inductance	L	H	30, 33, 34
Inductance, additional external motor choke	L_{ext}	H	46
Inductance, built-in choke controller	L_{int}	H	46
Inner radius	r_i	m	12, 13
Inner resistance, voltage source	R_i	Ω	29
Input speed	n_{in}	rpm	22, 23, 24, 25
Input torque	M_{in}	Nm	21, 22, 23, 25
Input voltage	U_{in}	V	30, 34
Joule power loss	P_J	W	38, 47, 49, 52
Length	l	m	13
Length of side a/b/c	$a/b/c$	m	13
Load current	I_L	A	32
Load force (output)	F_L	N	10, 21, 22, 23
Load force, 1 st /2 nd half cycle	F_{L1} / F_{L2}	N	24
Load resistance	R_L	Ω	29, 32
Load speed	n_L	rpm	25, 41, 45, 47
Load torque	M_L	Nm	11, 21, 25, 41, 45, 47
Load velocity	v_L	m/s	21, 22, 23
Load voltage	U_L	V	32

Name	Symbol	Unit	Page number
Mass	m	kg	9, 12, 13, 47
Mass, belt	m_B	kg	22
Mass, belt	m_R	kg	25
Mass, gear rack	m_Z	kg	23
Mass, gearhead	m_G	kg	47
Mass, motor	m_{mot}	kg	47
Mass of the load	m_L	kg	22, 23, 24
Mass, rover	m_F	kg	23
Mass, screw nut	m_S	kg	22
Mass, winding	m_W	kg	47
Maximum acceleration	a_{max}	m/s ²	16, 17
Maximum angular acceleration	α_{max}	rad/s ²	18, 19, 41
Maximum continuous torque, gearhead (catalog value)	$M_{G,cont}$	Nm	26, 47
Maximum current ripple, peak-to-peak	$\Delta I_{pp,max}$	A	46
Maximum efficiency at U_N (catalog value)	η_{max}		40
Maximum input speed (catalog value)	$n_{in,max}$	rpm	26
Maximum intermittent torque, gearhead (catalog value)	$M_{G,max}$	Nm	26
Maximum output speed gearhead	$n_{G,max}$	rpm	26
Maximum power	P_{max}	W	29
Maximum speed in load cycle	n_{max}	rpm	18, 19, 42
Maximum temperature change	ΔT_{max}	K	48
Maximum torque in load cycle	M_{max}	Nm	42
Maximum velocity	v_{max}	m/s	16, 17
Maximum voltage drop of the controller	ΔU_{max}	V	45
Maximum winding temperature (catalog value)	T_{max}	°C	50, 51, 52
Mean radius bearing	$r_{\mu L}$	m	11
Measurement resolution	ΔQ	qc/ms	44
Measurement resolution, motor speed	Δn	rpm	44
Mechanical input power	$P_{in,mech}$	W	21
Mechanical output power	$P_{out} / P_{L,mech}$	W	21, 38
Mechanical play, input	$\Delta \varphi_{in}$	rad	22, 23, 25
Mechanical play, load	$\Delta s_L / \Delta \varphi_L$	m/rad	22, 23, 25
Mechanical power	P_{mech}	W	21
Mechanical time constant (catalog value)	τ_m	s	41
Mechanical time constant with additional J_L	τ_m'	s	41
Moment of inertia	J	kgm ²	11
Moment of inertia with reference to the axis s through the center of gravity S	J_s	kgm ²	13
Moment of inertia with reference to the rotation axis x	J_x	kgm ²	12, 13
Moment of inertia with reference to the rotation axis y	J_y	kgm ²	12, 13
Moment of inertia with reference to the rotation axis z	J_z	kgm ²	12, 13
Moment of inertia, all wheels together	J_W	kgm ²	23
Moment of inertia, deflector pulley 2/X	J_2 / J_X	kgm ²	22, 25
Moment of inertia, driving end	J_1	kgm ²	22, 25
Moment of inertia, eccentric disc	J_E	kgm ²	24
Moment of inertia, gearhead transformed	J_G	kgm ²	25
Moment of inertia, input (motor, encoder, brake)	J_{in}	kgm ²	22, 23, 24, 25
Moment of inertia, load	J_L	kgm ²	25, 41
Moment of inertia, load	J_2	kgm ²	25
Moment of inertia, pinion	J_P	kgm ²	23
Moment of inertia, rotor (catalog value)	J_R	kgm ²	41
Moment of inertia, screw	J_S	kgm ²	22
Motor current	I_{max} / I_{mot}	A	38, 39, 40, 41, 42, 47, 49, 50, 52
Motor speed	n_{mot}	rpm	47
Motor torque	M_{mot}	Nm	47
Motor voltage	U_{mot}	V	38, 39, 40, 42, 47
No load current	I_0	A	39, 40, 42
No load speed	n_0	rpm	38, 39, 40, 41, 50
No load speed of motor at U_N (catalog value)	$n_{0,UV}$	rpm	45
Nominal current as a function of T_d	$I_{N,Td}$	A	50, 51
Nominal current, motor (catalog value)	I_N	A	46, 50, 51, 52
Nominal speed, motor (catalog value)	n_N	rpm	50
Nominal torque, motor (catalog value)	M_N	Nm	42, 50
Nominal voltage, motor (catalog value)	U_N	V	38, 39, 40, 45
Normal force (force perpendicular to the surface of contact)	F_N	N	9
Number of teeth, internal gear / pinion / sun wheel	$z_3 / z / z_1$		23, 25
OFF time	t_{off}	s	51
ON time	t_{on}	s	51, 52
Outer radius	r_s	m	12, 13
Output current	I_{out}	A	30
Output voltage	U_{out}	V	30, 34
Overload factor	K		52
Partial currents	I_1, I_2	A	31
Partial forces	$F_1 / F_2 / F_x$	N	10
Partial resistances	R_1, R_2	Ω	31, 32
Partial torques	$M_1 / M_2 / M_x$	Nm	11
Partial voltages	U_1, U_2	V	31, 32
Period	T	s	33
Periodic acceleration force as a function of the angle of rotation	$F_a(\varphi)$	N	24
Phase shift	φ	°	34
Pitch	p	m	23
Point 1/2 on the x -axis	x_1 / x_2	m	13
Position resolution	$\Delta \varphi$	°	44
Potentiometer position	x	0..1	32
Power	P	W	29, 38
Power losses / power losses, gearhead	P_V / P_{VG}	W	29, 48, 49, 50
Power losses for reversal of magnetization	$P_{U,magn}$	W	47

Name	Symbol	Unit	Page number
Pressure (1 Pa = 1 N/m ² = 10 ⁻⁵ bar)	p	Pa	9
Pull-down resistance	R_d	Ω	30
Pull-up resistance	R_u	Ω	30
PWM frequency	f_{PWM}	Hz	46
Quadcounts per pulse	$Q = 4$	qc/IMP	44
Radius / Radius 1 / Radius 2	$r / r_1 / r_2$	m	11, 12
Radius circular torus around z-axis	R	m	12
Reactance, capacitive	X_C	Ω	33, 34
Reactance, inductive	X_L	Ω	33, 34
Reduction ratio, gearhead (catalog value)	i_G		25, 26
Reduction ratio, mechanical drive	i		44
Required no load speed	$n_{0,theor}$	rpm	42
Required speed constant	$k_{n,theor}$	rpm/V	42
Resistance coefficient, copper	α_{Cu}	0.0039 K ⁻¹	32, 47, 49, 50, 51, 52
Resistance, potentiometer	R_O	Ω	32
RMS current	I_{RMS}	A	51
RMS torque	$M_{n,RMS} / M_{RMS}$	Nm	24, 42
Rotation angle / rotation angle change	$\varphi / \Delta\varphi$	rad	11, 15, 18, 19, 24
Screw lead (pitch)	p	m	22
Sinusoidal velocity curve of the load	$v_L(t)$	m/s	24
Source voltage	U_0	V	29
Specific heat capacity	c	J/(kgK)	47
Specific heat capacity copper	c_{Cu}	380 J/(kgK)	47
Specific heat capacity iron	c_{Fe}	450 – 470 J/(kgK)	47
Speed / torque gradient, motor (catalog value)	$\Delta n / \Delta M$	rpm/mNm	39, 40, 42, 45
Speed after acceleration	n_{end}	rpm	15
Speed before acceleration	n_{start}	rpm	15
Speed change	Δn	rpm	11
Speed change, input	Δn_{in}	rpm	22, 23, 24, 25
Speed constant (catalog value)	k_n	rpm/V	39, 40, 42
Speed of rotation / Speed of rotation (change)	$n / n, \Delta n$	rpm	15, 21, 38, 39, 40, 41, 42, 45, 47, 50
Spring constant	k	N/m	9
Spring force	F_S	N	9
Stall torque	M_H	Nm	38, 39, 40, 41, 42
Stall torque at temperature T_W	$M_{H,T}$	Nm	47
Stands for X_C or X_L	X	Ω	33
Starting current	I_A	A	39, 40
Starting current at temperature T_W	$I_{A,T}$	A	47
Stored heat	Q	J	47, 48
Supply voltage	$\pm V$	V	30
Supply voltage	V_{CC}	V	45, 46
Temperature	T	°C	47, 48, 49, 51, 52
Temperature at start	T_{start}	°C	48
Temperature change as a function of time t	$\Delta T(t)$	K	48
Temperature difference	ΔT	K	47
Temperature difference, gearhead-ambient	ΔT_G	K	49
Temperature difference, stator-ambient	ΔT_{s-a}	K	48, 49, 50, 51
Temperature difference, winding-ambient	ΔT_{W-a}	K	48, 49, 51, 52
Terminal inductance, motor (catalog value)	L_{mot}	H	40, 46
Terminal resistance, motor (catalog value)	R_{mot}	Ω	32, 38, 39, 40, 41, 47
Terminal voltage	U_U	V	29
Therm. resistance, gearhead-ambient	$R_{th,G}$	K/W	49
Therm. resistance, housing-ambient (catalog value)	$R_{th,D}$	K/W	48, 49, 50, 51, 52
Therm. resistance, housing-ambient modified	$R_{th,D,mod}$	K/W	50
Therm. resistance, winding-housing (catalog value)-	R_{th}	K/W	48, 49, 50, 51, 52
Therm. time constant, motor / winding (catalog value)	τ_M / τ_W	s	49, 52
Thermal time constant	τ_{th}	s	48
Time / Time, duration	$t / t, \Delta t$	s	14, 15, 24, 30, 33, 41, 47, 48, 49, 51, 52
Time $a / b / c$	$\Delta t_a / \Delta t_b / \Delta t_c$	s	16, 18
Time change	dt	s	40
Torque	M	Nm	11, 21, 38, 39, 40, 41, 42, 45, 47, 50
Torque at operating points 1...n	$M_{n,n}$	Nm	42
Torque constant (catalog value)	$k_{T,n}$	Nm/A	39, 40, 41, 42, 47
Torque for acceleration	$M_{acc} / M\alpha$	Nm	11, 22, 23, 24, 25
Torque for reversal of magnetization	M_{mag}	Nm	47
Torque, 1 st / 2 nd half cycle	$M_{1/2}(p) / M_{2/2}(p)$	Nm	24
Torque, spiral spring	M_S	Nm	11
Torsion coefficient (spring constant)	k_m	Nm	11
Total current	I	A	31, 32
Total inductance	L_{tot}	H	46
Total time	Δt_{tot}	s	16, 17, 18, 19
Total time, operating cycle	t_{tot}	s	42
Total voltage	U	V	31, 32
Velocity / Velocity (change)	$V / V, \Delta V / \Delta v$	m/s	9, 14, 21
Velocity after acceleration	v_{end}	m/s	14
Velocity before acceleration	v_{start}	m/s	14
Voltage	U	V	29, 33
Voltage over capacitance / inductance / resistance	$U_C / U_L / U_R$	V	34
Voltage, potential difference	U_1 / U_2	V	48
Weight of a body	F_G	N	9
Winding resistance at current temperature T_W	R_{TW}	Ω	32, 47
Winding resistance at temperature T_A	R_{TA}	Ω	49, 50, 51, 52
Winding temperature	T_W	°C	32, 47

