

The maxon motor magazine

# driven

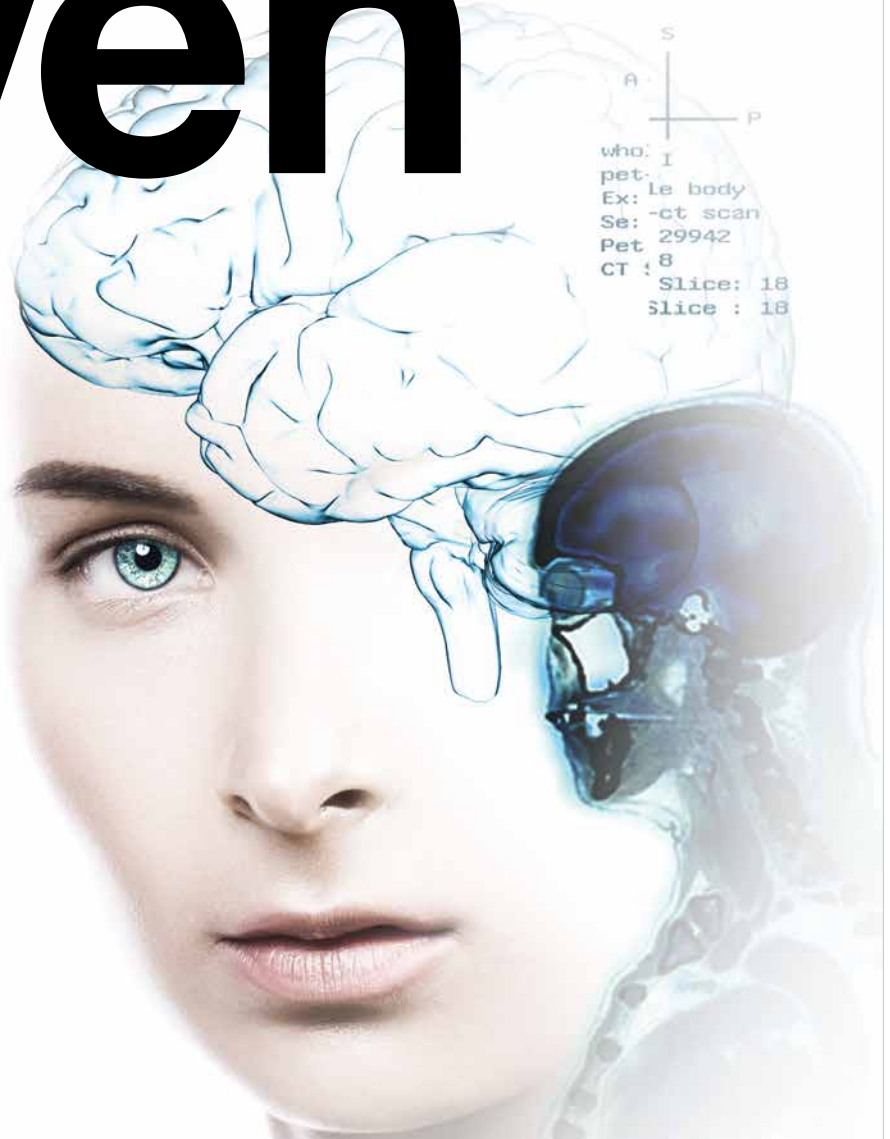

## People. Medicine. Technology.

How we benefit from progress

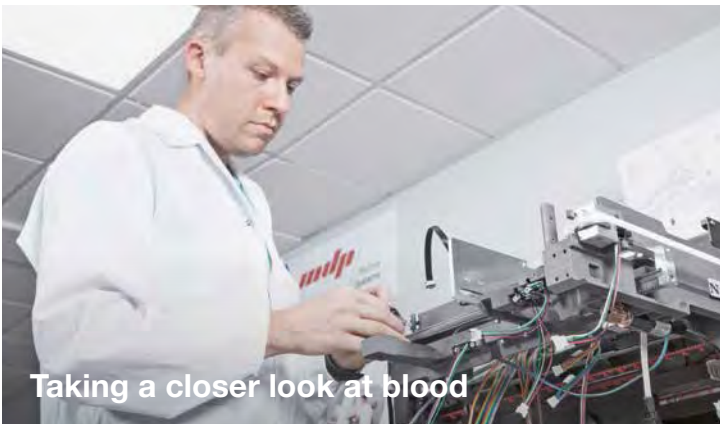

Taking a closer look at blood



Under power: from "furka" to "gotthard"



p. 18



p. 5



p. 38



p. 21

p. 7



p. 30



p. 8



p. 34

p. 22

p. 26

4 News

**Focus on medical technology**  
 8 People. Medicine. Technology.  
 New technologies minimize the risks of medical procedures – with robots and 3D laser navigation.

**Exploration**  
 18 A place of learning and living robotics  
 The Swiss Federal Institute of Technology in Lausanne is successfully researching robotics. One of the products: mechatronic pants.

**maxon history**  
 21 Everybody a TV station director  
 VCRs – innovation in the 1960s. maxon developed new motors for Grundig in record time.

**maxon inside**  
 22 Taking a closer look at blood  
 High-tech machines analyze human blood samples, detect coagulation disorders, and help to save lives – using pump modules from maxon France.

**Innovation**  
 26 600 meters below the ice  
 Scientists explore the kilometers-thick ice cover of Antarctica using entirely new technology.

**Innovation**  
 30 Under power: from “furka” to “gotthard”  
 The AMZ Racing Team has already set a world record: Their electric race cars accelerate faster than any combustion engine.

**Expertise**  
 34 On the heating of motors in hand-held tools  
 Hand-held devices should not become too hot. How should a motor be designed to accomplish this?

**Special**  
 38 A piece of freedom  
 Othmar Zoll is confined to a wheelchair. With his handbike and the maxon Bikemotor, he is still on the road and outdoors every day.

**Contest**  
 42 Where is this image detail hidden?  
 Join and win a Garmin multi-sports watch.

Editorial

# One cannot help but wonder at the progress medical technology has been making



Eugen Elmiger, CEO, maxon motor ag

Innovation is a word that gets used quite a lot. Everybody wants to be innovative – advanced, intelligent, cutting-edge. However, there is no industry where these attributes are a better fit than medical technology. In this field, more than 12,474 new patents were registered in 2015 (see page 6).

The pace of development is breathtaking. Machines and tools are becoming smaller, more efficient, and more precise. These days, surgeons are performing minimally invasive operations using robots that hardly leave a scar. Types of eye surgery that used to be extremely risky are becoming routine. And it looks like it's only a question of time until surgical tools will be able to reach a certain place in the brain while avoiding sensitive areas that are in the way (see focus).

maxon motor has a ringside seat in the development of new technologies for medical applications in universities, start-ups, and large corporations. We are supporting a lot of promising projects with our expertise, and we are always glad when the moment of breakthrough comes that lets doctors and patients benefit from new products.

Happy reading!

Photos: maxon motor ag / Philipp Schmidli, Daniel Grillat, Preceyes, Ethan Gardner

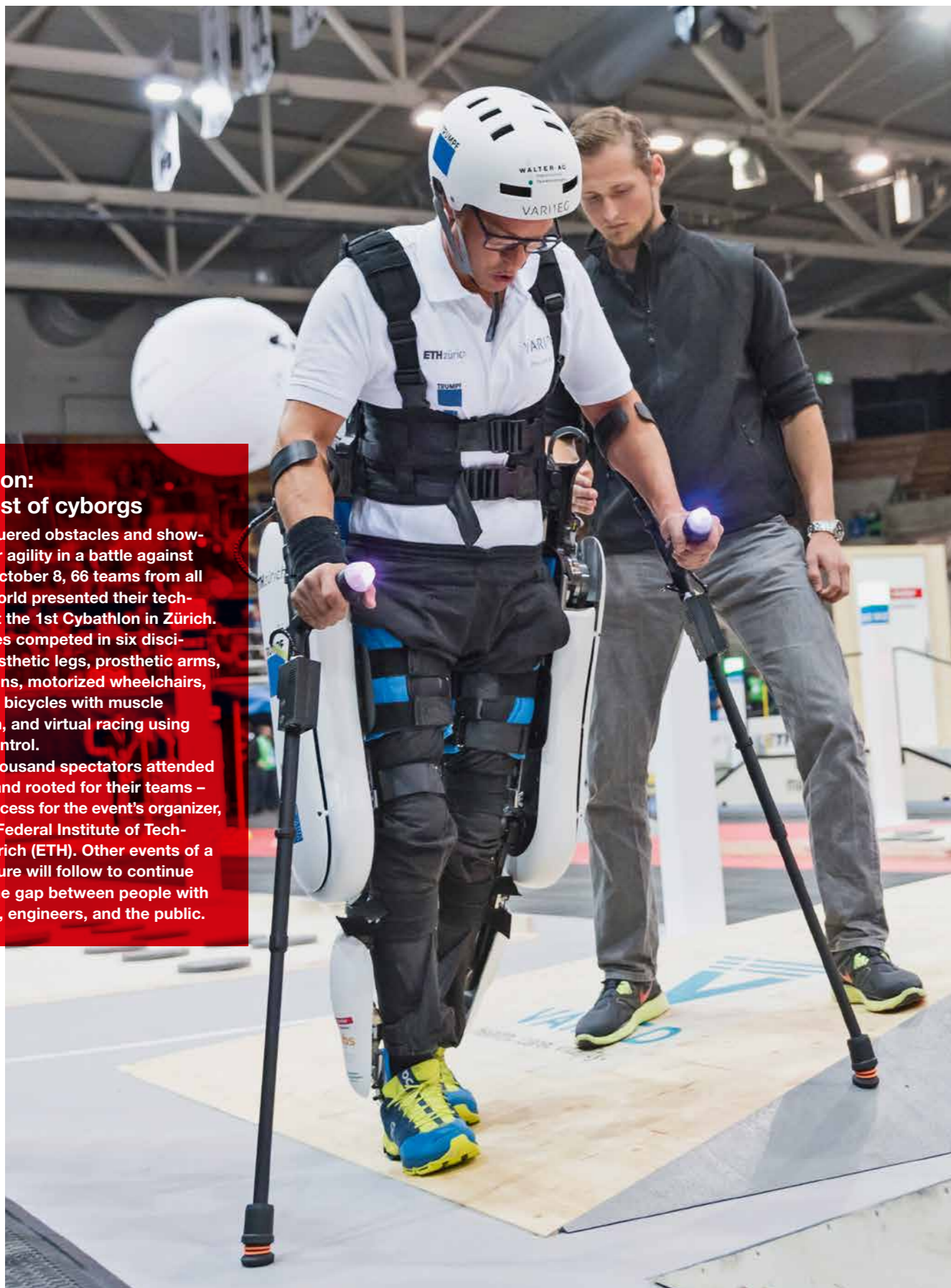

**Cyathlon:  
A contest of cyborgs**

They conquered obstacles and showcased their agility in a battle against time: On October 8, 66 teams from all over the world presented their technologies at the 1st Cyathlon in Zürich. The athletes competed in six disciplines: Prosthetic legs, prosthetic arms, exoskeletons, motorized wheelchairs, recumbent bicycles with muscle stimulation, and virtual racing using thought control.

Over six thousand spectators attended the event and rooted for their teams – a great success for the event's organizer, the Swiss Federal Institute of Technology, Zürich (ETH). Other events of a similar nature will follow to continue bridging the gap between people with disabilities, engineers, and the public.

Mars missions for everybody

**maxon builds a rover for the Swiss Museum of Transport**

With half a million visitors per year the Swiss Museum of Transport is the most successful museum in the country. An interactive exhibition shows vehicles of all kinds: cars, trains, airplanes and ships. Now the Lucerne museum is updating its space exhibition, with a contribution from maxon motor. What could be a better topic than Mars? After all, maxon won worldwide recognition for its involvement in NASA's Mars missions.

The drive specialist is designing a Mars landscape for visitors to walk around in and learn about the Red Planet. The display also contains scale 1:1 models of the Mars rovers Sojourner, Opportunity, and ExoMars. maxon trainees built all three models and fitted them with moving parts, such as the drilling unit or the camera head. The rovers are also positioned

so that visitors will be able to take selfies with them.

**ExoMars rover launching in 2020**

maxon has contributed a large number of drives to all the original rovers. Opportunity is equipped with 35 DC motors, for example. The ExoMars rover is even built with entire modules that were assembled by maxon. They drive the vehicle and are in charge of the steering. However, the ExoMars rover is still on Earth at this point. The mission is scheduled to launch for Mars in 2020.

[verkehrshaus.ch/en](http://verkehrshaus.ch/en)



**Top:** Sojourner is one of three Mars rovers in the new space exhibition at the Swiss Museum of Transport.

**Right:** Trainees at maxon motor proudly present their ExoMars rover.



Photos: ESA/Boris Bietige, maxon motor ag

# 12,474

Medical technology is booming. In 2015 there were 12,474 patent applications in this field. The U.S. is the leader and filed the most applications (5,158) by a large margin, followed by Germany (1,456) and Japan (1,152). The largest increase compared with the previous year was in Switzerland (+22.2 %) and China (+17.7 %), followed by the U.S. (+17.1 %). There is a lot of potential for new, innovative products in medical technology.

Do you have ideas for new patents? We look forward to hearing about your projects and are happy to support them with our knowledge and our products. Contact us: [contact.maxonmotor.com](mailto:contact.maxonmotor.com)



Stories, blogs, and innovations in drive technology

## drive.tech – new website for technology aficionados

We have a treat in store for drive technology aficionados: There is a new website with stories about robots, Mars vehicles, and electro-mechanical prostheses, as well as blogs about energy efficiency in drives, motor selection, and current industry trends. The drive.tech site is backed by none other than maxon motor, the leading manufacturer of DC motors and drive systems.

### Young engineers present their projects

drive.tech is an English-language page with continuously updated contents. It is also a platform for interesting projects from all over the world where start-ups and teams of students supported by maxon present their inventions. Readers can keep up to date on the latest developments in drive technology and are able to share popular entries with friends.

drive.tech

On drive.tech, technology aficionados may find interesting stories, news and knowledge from the field of drive technology.

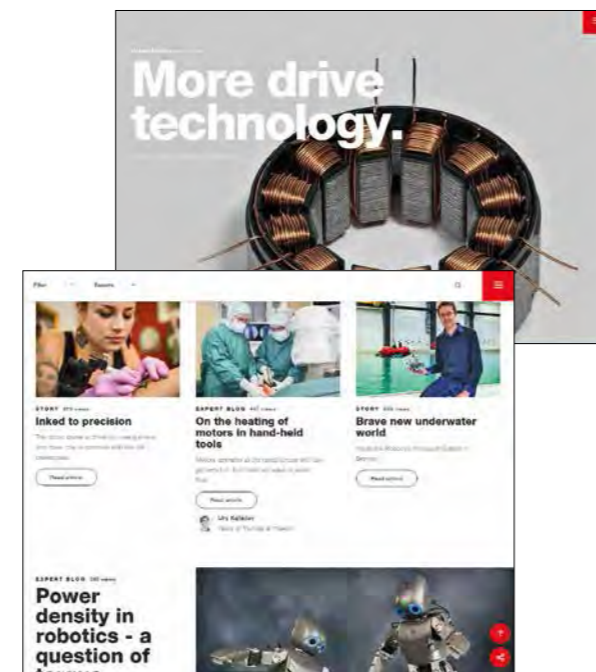

Photos: maxon motor ag, Gettyimages / B2M Productions

## NEW PRODUCTS

Frameless motors

### High power packed into extremely small spaces

There are cases where flat motors are difficult to integrate in a structure. The joints of robots are an example. Drive specialist maxon motor therefore offers its brushless flat motors as a frameless motor kit. Rotor and stator are delivered separately, without bearings and motor shaft, and connected only when the components are assembled. This gives the customer the best of both worlds: high torque density and minimum volume. With outer diameters from 32 to 90 millimeters, the brushless DC motors are extremely compact. Designed as external rotor motors, they offer plenty of space inside for cable glands. maxon delivers them with or without a Hall sensor for easy control.



maxon EC 45 flat  
Ø 45 mm, brushless



maxon EC 90 flat  
Ø 90 mm, brushless

GPX sterilizable

### High-performance gearheads for high-speed BLDC motors

High speeds of up to 120,000 rpm, hardly any heat, and smooth operating behavior. These are the outstanding characteristics of maxon's brushless ECX motors, which were introduced to the market about a year ago. They come in the versions standard, high-power, ceramic, and sterilizable. However, good motors also need strong gearheads. That's why maxon is now offering the GPX Speed planetary gearheads with diameters of 16 and 22 millimeters. These sizes are sterilizable and available with a shaft seal. The GPX deliver the necessary power, for example for hand-held saws and drills. They can be configured as desired in the maxon configurator and are ready for shipping in 11 days.

All maxon products and specifications, CAD data, and manuals are available in the online shop. [shop.maxonmotor.com](http://shop.maxonmotor.com)



maxon GPX 16 Speed  
Ø 16 mm, sterilizable

# Always improving

Every surgical operation has inherent risks. New technologies help to minimize these risks, with robotic assistance in eye operations, flexible tools for complex brain surgery, or high-precision 3D navigation for computer tomography.

**M**edical technology is a field with very dynamic development. New devices and technologies reach the market every year. Current trends include stress reduction through advanced surgical methods, further minimization of invasiveness, and computer-assisted navigation to support surgeons. Manufacturers of medical products invest around 10 percent of their sales revenues in research and development. On average, 50 percent of the revenues are made with products that are younger than two years. The impressive power of innovation in this industry also shows in the constant increase in patent applications. maxon drives can be found in numerous medical applications – after all, medical technology is maxon's largest market.

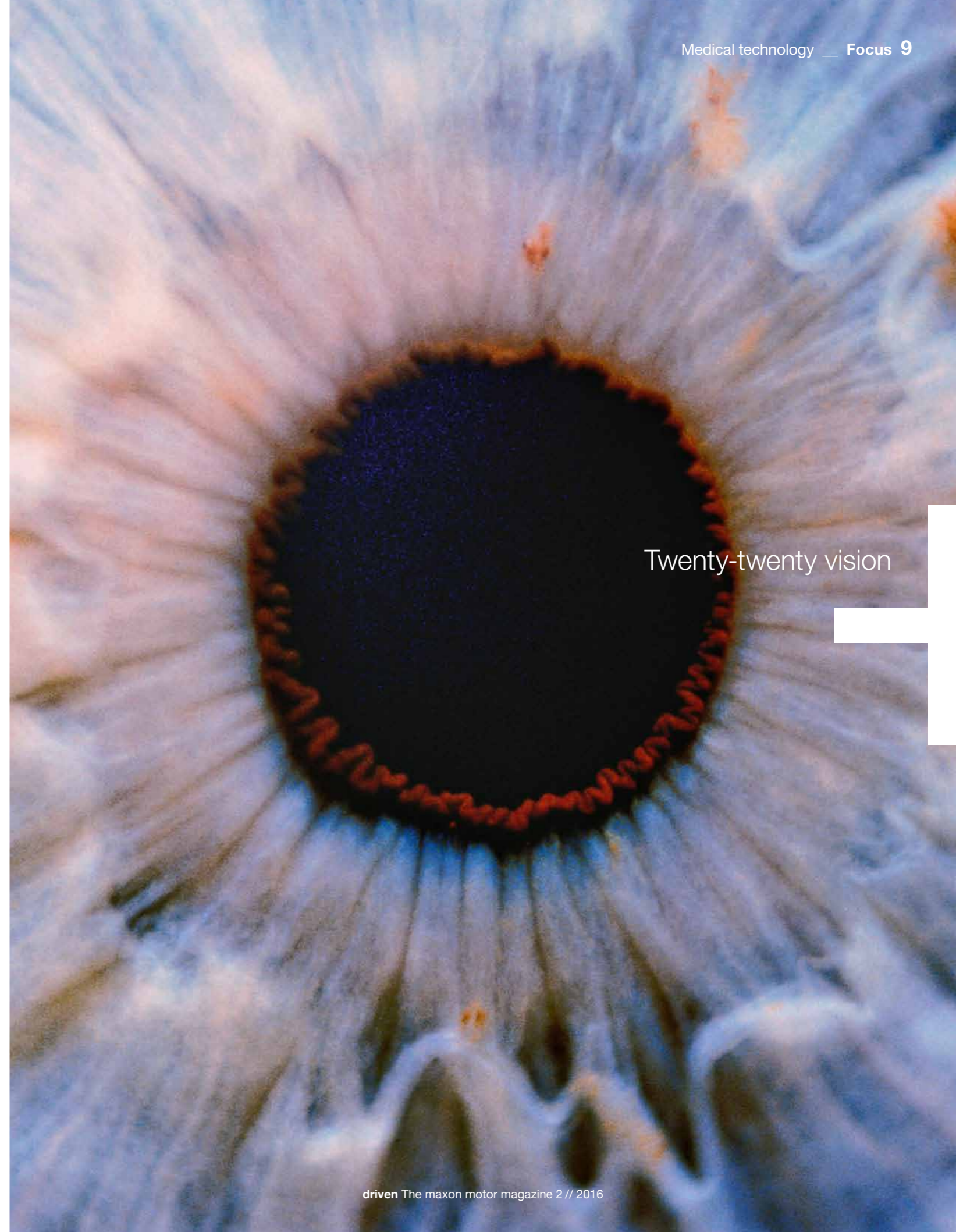

Twenty-twenty vision



Robotic assistance enables types of eye surgery that were impossible before: a world first.

Photos: iStock/Firstsignal, Preceyes, Imperial College

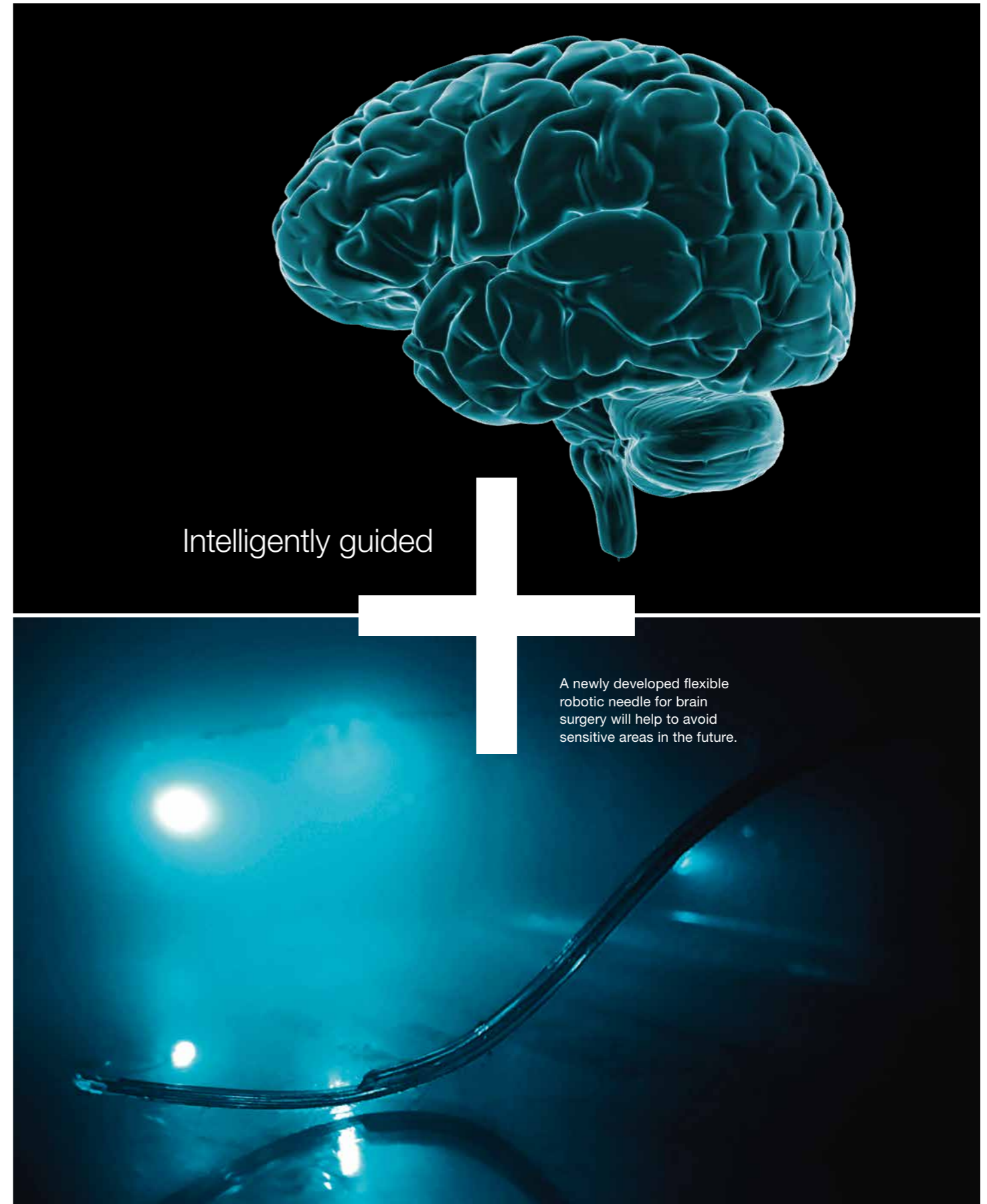

Intelligently guided

A newly developed flexible robotic needle for brain surgery will help to avoid sensitive areas in the future.

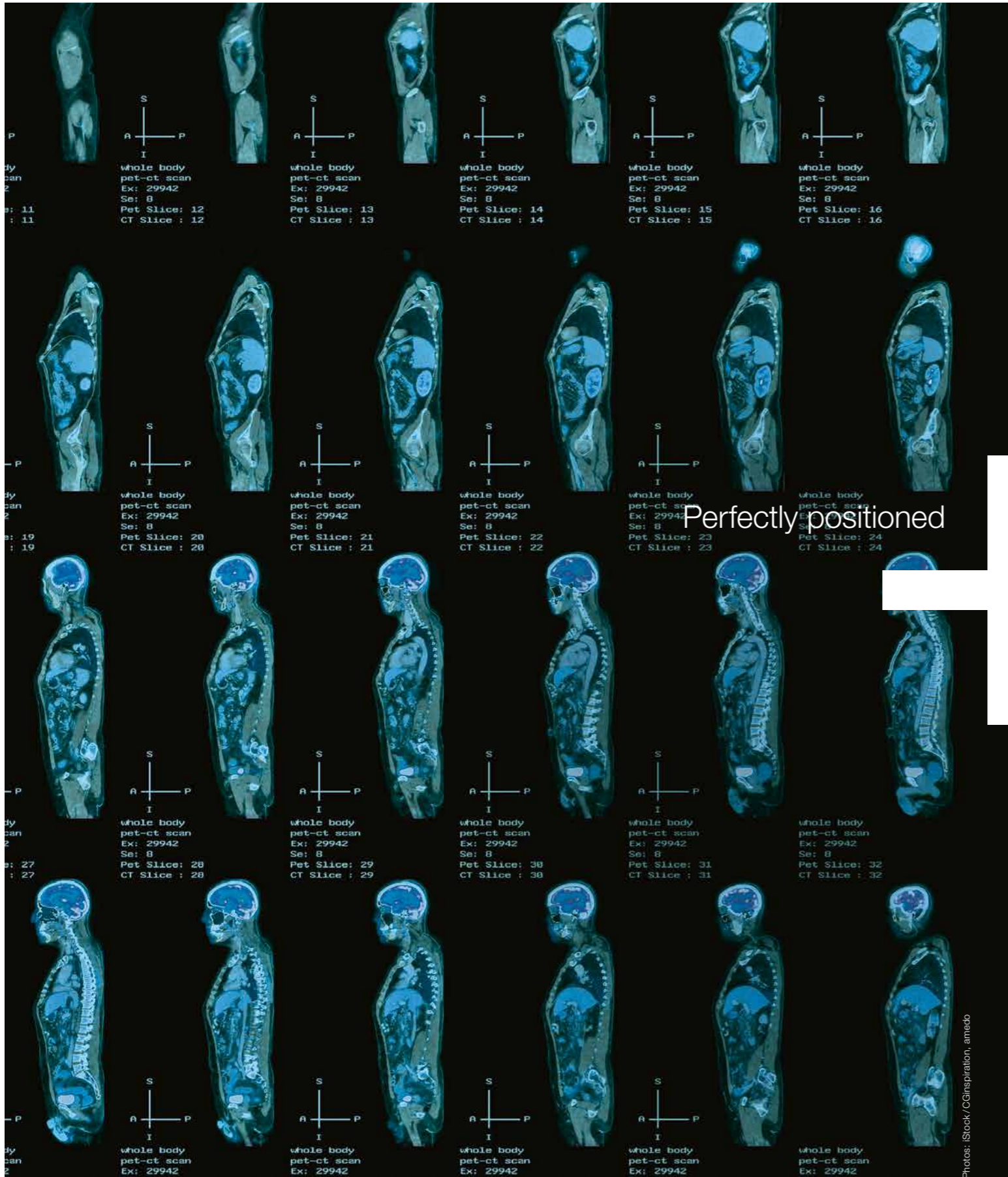

## Perfectly positioned: A laser shows the way

The Radiology department at the University Hospital of Basel has state-of-the-art equipment. In addition to the world's first 3D X-ray device, the hospital also relies on a new laser navigation system for CT scanning – guided minimally invasive surgery. "It offers a lot of advantages for image-guided operations," explains Dr. Christoph Zech, head of the Interventional Radiology department at the University Hospital of Basel.

### Visualizing the invisible

Since 1974, CT scans have been used to create detailed cross-sectional X-ray images of the human body. Doctors use these high-resolution

**A laser ensures that the needle is inserted with millimeter precision.**

images in their decision making, e.g., on where to take a tumor sample. But how do they reach that target? Where

exactly do they place the needle tip, and what is the correct angle? Until now, this used to be a difficult challenge – every millimeter counts. Here's where the fully automated laser navigation system made by the company amedo comes in. The device consists of a ceiling-mounted, arc-shaped rail on which a motorized laser positioning unit is mounted. That's all – a simple system that makes a big difference for doctors and patients alike.

### Lower radiation exposure

The navigation system uses a laser beam to project the needle's point of entry on the patient's skin and visualize the needle path along which the radiologist needs to move the instrument. Dr. Zech uses a foot switch to adjust the exact position of the needle. This triggers an imaging sequence to monitor the ongoing operation, the infiltration of a nerve root. The monitor of the CT scanner shows the position of the 0.7-millimeter-thin needle.

It is already in the correct position in the first set of frames. "Here's where the new laser navigation system is extremely helpful," says Zech. The intrusion depth of the needle is also displayed. Additional CT scans to determine the position are hardly necessary any longer, which significantly reduces the radiation exposure for the patient. With traditional technology, the position of the needle had to be checked at least two or three times.

### maxon motors position the laser

Brushless maxon drive systems are used to ensure that the laser unit moves precisely on the device's rail. The unit is equipped with a brushless flat motor with a 45-millimeter diameter, combined with the GS45 planetary gearhead and an MR encoder. Via a synchronizing pulley, they drive an endless belt that moves the carriage along the arc. The rotating laser pointer is installed in this carriage. Two more maxon motors control the mechanical rotation of the laser mirrors: brushless EC-max 16. Combined with GP 16A planetary gearheads and MR encoders, they enable a precise positioning of the laser beam to show any angle as required for the operation. The motors are controlled using three EPOS2 Module 36/2, taking into account all process parameters as well as the communication with the control computer. According to Volker Tröskén, managing partner at amedo, the small-form factor and reliability were the main points in favor of the maxon drive systems.

The young medical technology company from Bochum, Germany, has developed a device that did not exist before in the market. The success is impressive – a total of 16 devices are already in use worldwide. The team of six has acquired sales partners in 14 countries. "We recognized the surgeons' need for a solution that provides an easy-to-use, low-risk, and time-saving navigation aid for CT-controlled surgery and developed our laser navigation system together with the Grönemeyer Institute for Microtherapy here in Bochum."



After the radiologist has determined the needle's path on the CT planning images, the laser head moves into position on the arced rail and projects a laser dot on the patient's skin.



maxon EC 45 flat  
Ø 45 mm, 30 W, brushless

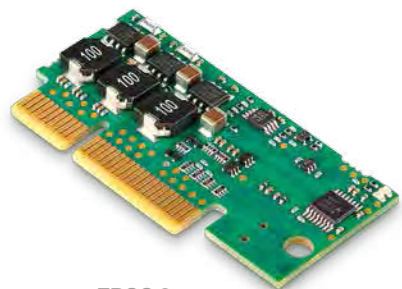

maxon EPOS 2  
Module 36/2



A physician pierces a patient's skin with the fine needle and aligns it with the laser so that the dot is at the center of the needle. The calculated insertion depth is monitored by means of markers on the needle.

Photos: amedo, maxon motor ag



## Intelligently guided: A wasp shows the way

What do wasps have to do with brain surgery? At first glance, not a whole lot. However, one species serves as the model for an innovative brain surgery needle that is being developed by a team of researchers from England. In tumor treatment, neurosurgeons today use a thin, rigid needle to inject medication into the affected brain tissue. This carries a relatively high risk of injuring healthy tissue, because a rigid needle only allows the surgeon to enter a certain region of the brain, following a straight path. The ideal solution would be a flexible operating tool.

This is where the London Imperial College comes in. In recent years, a team led by Prof. Rodriguez y Baena worked on developing a flexible robotic needle capable of reaching the deeper regions of the brain, while simultaneously avoiding especially sensitive areas. The young researchers seek to imitate the special mechanism employed by female wood wasps

**The needle passes around sensitive areas.**

that use their thin but very strong drill-like stings to lay eggs inside the wood of trees. Under the project name STING (Soft Tissue Intervention and Neurosurgical Guide), the scientists developed

a prototype consisting of four segments with an overall diameter of 2.5 millimeters, hold together by a puzzle-like interlocking mechanism. maxon drives provide the back-and-forth motion of the segments

### “The whole range”

Dr. Secoli is a member of the Mechatronics in Medicine Lab at the Imperial College. He selected the brushless maxon EC20 flat motor with a GP22 planetary gearhead for the application. An EPOS 24/2 positioning controller

provides exact positioning. “Easy access to the API (Application Programming Interface) was the major key criterion of selection. On top of that, for fast-prototype system, maxon is the only manufacturer that offers the whole range of products: motor, gearhead, controller” says Dr. Secoli.

In early 2016, the team received a grant of 8.3 million euros from the European Union within the funding scheme Horizon2020. The new project codename EDEN2020 (Enhanced Delivery Ecosystem for Neurosurgery www.eden2020.eu), aims to set a new standard in the field of neurosurgical diagnostics and therapy by 2020. ■

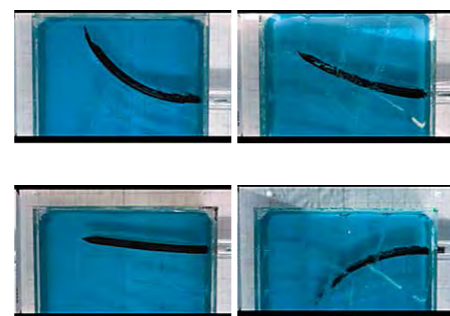
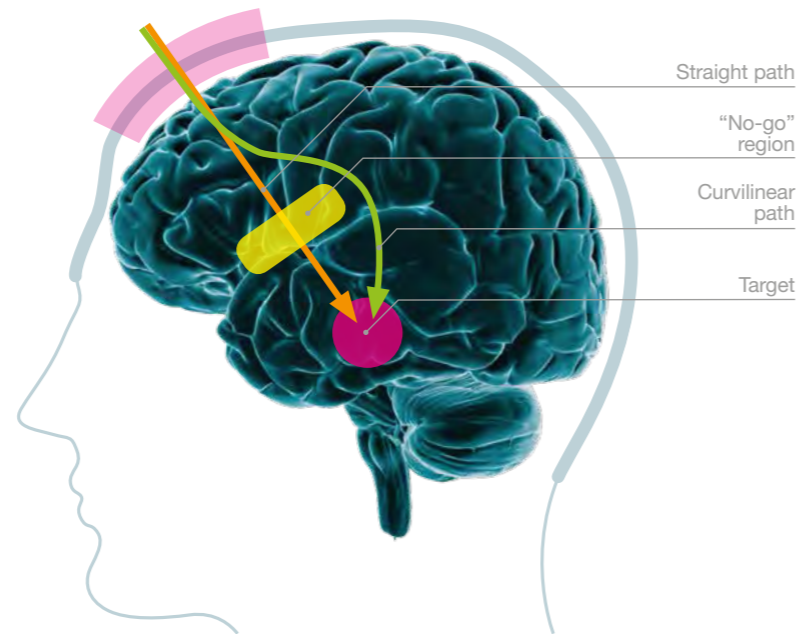

During the operation, the needle flexibly follows the shape of the brain (top image). Unlike a rigid needle, the flexible needle is able to avoid critical areas of the brain (bottom image).

Photos: iStock/Firstsignal, Imperial College, Preceyes

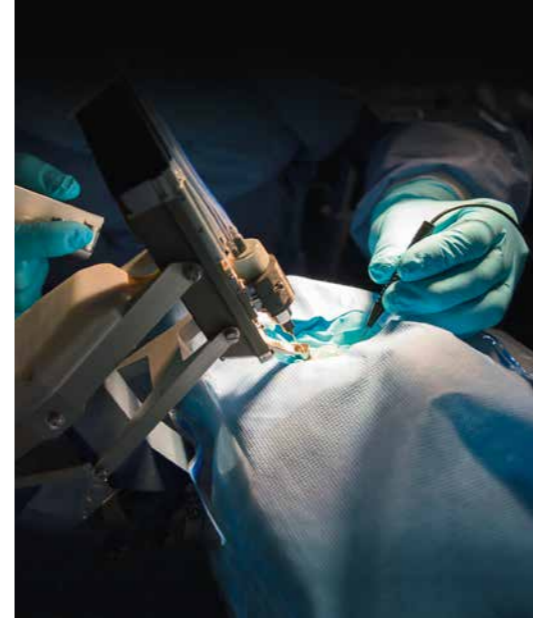

The new robotic system is used in surgery to treat disorders of the retina. Precision with a joystick: When the surgeon moves the joystick by a centimeter, the robotic arm at the extension moves only by a millimeter.

## Twenty-twenty vision: a world first in eye surgery

While robotic assistance systems are available for most types of surgery today, eye surgery used to be an exception. A Dutch company has changed that. The first operation using the system was successful.

Worldwide, about 50 to 70 million people are suffering from visual impairment due to disorders of the retina. Adequate treatment is still impossible in many cases. Eye operations are always a big challenge for a surgeon, and steady hands are a key requirement. Surgeries like those for treating a detached retina require extreme precision. And when it comes

to precision, human hands can't hold a candle to robotic systems.

### Ten to twenty times better precision

This is why the company Preceyes, which originated as a spin-out from the University of Eindhoven (Netherlands), has developed a completely new robotic system for eye surgery. Specially designed for the treatment of retina disorders, the assistance system improves precision by a factor of 10 to 20 compared with the human hand. This allows operations to be performed that are currently impossible due to lack of precision – an enormous gain for patients, but also for surgeons, whose effectiveness and accuracy will be vastly improved. The world's first robot-assisted operation inside the eye was performed successfully at the John Radcliffe Hospital, Oxford. “This is the culmination of 10 years of work. The ease with which Professor MacLaren was able to perform the surgery is an important step ahead for robot-assisted eye operations and a clear vindication of our technology,” says Marc de Smet, MD Chief Medical Officer at Preceyes.

### Haptic feedback

The functional principle is straightforward: While the operating surgeon is sitting next to the patient's head looking through a microscope, he is operating a joystick whose motion is transmitted to a robotic arm (slave). The robot downscales the motion: When the surgeon moves the joystick by a centimeter, the tip of the robotic arm moves only by a millimeter. Meanwhile, the other hand performs manual tasks as required. The system is designed to allow surgeries to be performed with motion control alone as well, using two joysticks and two robotic arms. In addition to a haptic feedback function that not only lets the surgeon see but also feel his actions, the robotic system also supports quick retooling. This is an important factor because it reduces the time required for an operation. The motions of the robotic arms are performed by high-precision drive systems of maxon. ■

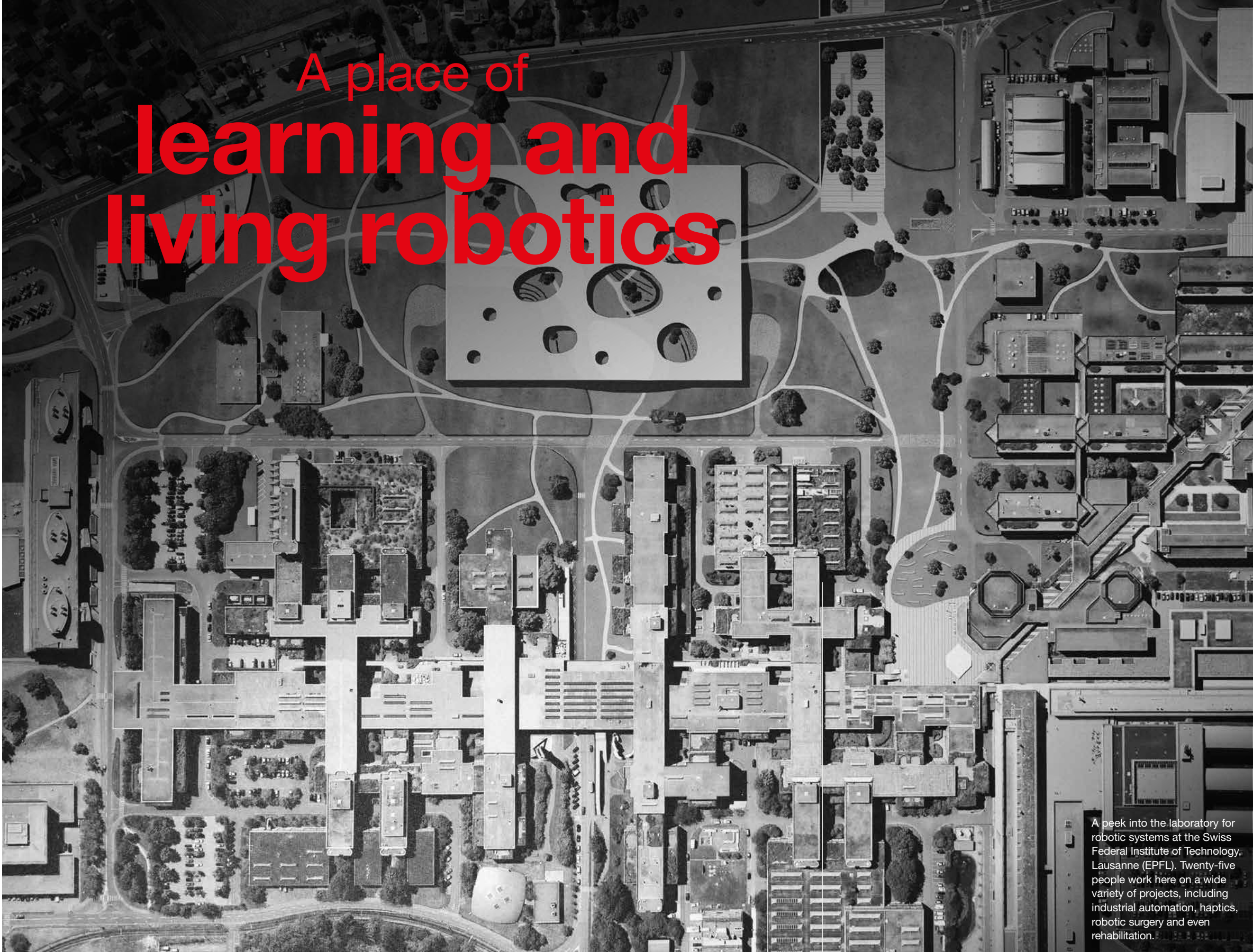

# A place of learning and living robotics

At the Swiss Federal Institute of Technology in Lausanne students and researchers work in various fields of robotics. Time and time again, they develop commercially successful products. Maybe these products will include a pair of mechatronic pants in the near future.

**A**fter a few steps, the motors engage, transmitting their torque to my legs via a spindle. The knees go up. Left, right. Step by step, the exoskeleton supports me. I still have to walk by myself, but it feels like I'm being pushed forward. It's a very strange sensation. Still, walking is surprisingly natural. Lateral leg movement is possible, for example – and the device I'm wearing is only a prototype.

#### **Better mobility for the elderly**

Hibso (that's what the exoskeleton is called) was developed at the Laboratory for Robotic Systems (LSRO) of the Swiss Federal Institute of Technology, Lausanne (EPFL). The goal of the project is to develop an aid for seniors who, despite limited mobility, are still able to walk and stand. Users should be able to don the device without help and regain some of their mobility in this way, explains Dr. Mohamed Bourri, Director of Rehabilitation and Robotic Assistance Systems. However, there is still a lot of work to do before the product will

A peek into the laboratory for robotic systems at the Swiss Federal Institute of Technology, Lausanne (EPFL). Twenty-five people work here on a wide variety of projects, including industrial automation, haptics, robotic surgery and even rehabilitation.

be ready for series production. For the time being, Hibso remains a research project that is being developed in the laboratory by students and Ph.D. candidates. Climbing stairs is still a problem that needs to be solved, for example. Also, people's heart rate increases when they are wearing the device. The researchers are trying to eliminate this by making the movements more natural.

#### Interdisciplinary research

The laboratory for robotic systems has a lot more to offer. About 25 scientists are working on a wide variety of projects. Visitors can find

research in progress and developments in fields as varied as industrial automation, haptic systems, surgical robots, and rehabilitation. Some

**The mechatronic pants are a walking aid for people with mobility impairments.**

orders come directly from industrial customers, others are government-funded research projects. "Our work brings us into contact with many different disciplines. This isn't just interesting, it's also a lot of fun," says Professor Hannes Bleuler, the director of the laboratory.

#### Inventor of the Delta robot

During the walkabout, it is noticeable that many of the robots are based on a parallel design. There is a history to this: After all, the LSRO is where the Delta robot was invented in the early 1980s. Today the Delta is a commercially successful pick-and-place robot used in industrial automation. "We think that the parallel design still has a lot of potential," says Jeremy Olivier, who works at the lab. "While it usually takes up more space, it is also a lot lighter than other designs."

At the LSRO, the parallel design is recently being used for innovative surgical robots that are employed in minimally invasive operations, e.g., operations in the abdomen where the robot arms are inserted through very small incisions. Previous models used to be equipped with three or four arms, each of which needed its own "entrance" into the body. The currently tested models require only one opening. The operator uses a panel to control two manipulators, which are hidden in a tube and unfold only inside the patient's body. A possible advantage of this method is that using the tools is natural for

the surgeon, similar to working inside the body with his hands. The healing process after surgery is also shorter.

It is still uncertain when and how this technology will be used in practice. If successful, it would be another proof of the innovative power of the EPFL's robotics laboratory. ■

The exoskeleton is designed to support elderly people who have restricted mobility but are still able to stand and walk.



maxon RE 30  
Ø 30 mm, 60 W,  
graphite brushes

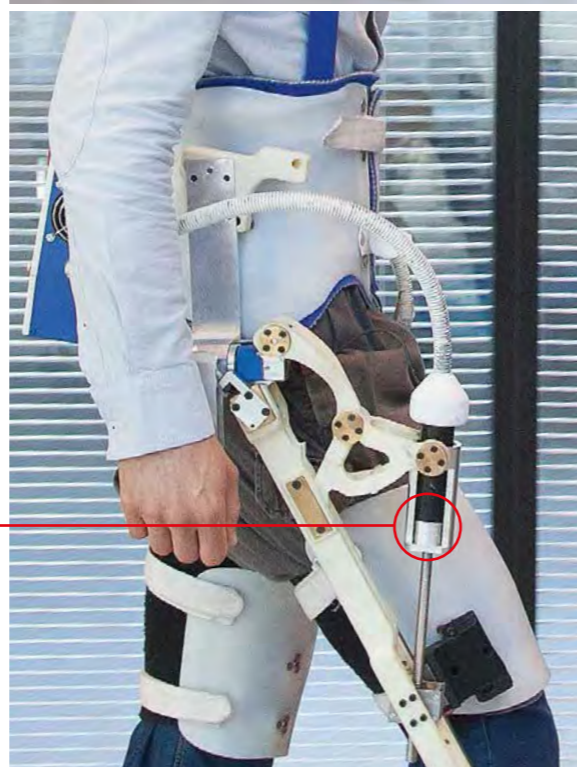

Photos: Peter Fauland, maxon motor ag, Grundig

1978

## Everybody a TV station director

The first VCRs for home use were introduced to the market in the early 1960s. At the time, maxon developed the motors for Grundig VCRs in record time.



An original Grundig motor

In 1978, video tape recorders were still widely seen as technological miracles of astonishing complexity. For many people it was just amazing that they were suddenly able to record TV programs, and that even 10 days in advance. The Grundig device was special in that it offered five hours of uninterrupted runtime with a very high image quality.

In its time, the Grundig SVR 4004 was among the most advanced image recording devices available. maxon was only able to conquer the consumer electronics market because the company had developed the motors for Uher tape machines in the previous year (see driven 1/2016). maxon developed two new motors very quickly for this project. The old location in Sarnen (Obwalden canton) produced motors for the Grundig system in large quantities. Two motors of this type, which had the model designation 2055, were

used for winding the half-inch magnetic tape of the SVR (Super Video Recording) system. SVR was Grundig's own version of the VCR system for recording TV images on tape.

The maxon motors at the time were critical for enabling the function of such a complex drive. In addition to the maxon motors, four more motors were needed for the function of the video recorder.

One reason for the failure of the system was that Grundig did not produce for the US market, at the time the biggest market for consumer electronics in the world. This made low-cost mass production impossible. The system was eventually discontinued in 1981. ■



mdp technician Yannick Charel assembles the transport unit for the medical analysis device.

Photos: maxon motor ag / Daniel Gilliet, iStock / harmpati

# Taking a closer look at blood

High-tech machines analyze human blood samples, detect coagulation disorders and thus help to save lives. The maxon sales company in France does not only supply the appropriate drives – in fact, it builds entire conveyor modules. A peek inside.



## Coagulation disorder: What is it?

The field of hemostasis diagnostics looks at disorders that affect the coagulation (blood clotting). If the coagulation is out of whack, various ailments and disorders can occur. For example, if the coagulation is too fast, thrombosis can result, in other words, blood clots can form. This can clog the veins or arteries and in some cases even lead to a pulmonary embolism.

**O**ur blood is a fascinating fluid. It transports oxygen and nutrients, fends off foreign objects and closes wounds. At least in normal cases. Some people, however, suffer from coagulation disorders (see box). These cases are unpleasant for the patient and can have severe consequences – or even lead to death. This is why early detection of a blood disorder and the hunt for a cure are so important. This requires a lot of testing. Analysis devices in laboratories and hospitals run around the clock and are able to autonomously pipette samples to deliver quick results. Such industrial automation equipment has to work with high accuracy and reliability. This places high demands on all components and the developers.

## Fully automated blood analysis

Stago is a French company that specializes in analysis instruments for hemostasis diagnostics, in other words for testing blood clotting. Around 20,000 devices of Stago are in use across the world – including the StarMax. This fully automated analysis system is equipped with a three-axes robot and offers

space for 215 samples and 1,000 test containers. The machine works autonomously, checks the results, compares them and monitors the processes. This saves the biologists and technicians a lot of time. Therefore the device is particularly suitable for laboratories with a large sample volume.

## Precision on three axes

StarMax was introduced to the market in late 2014. Yet Stago developed its first analysis device with an X-Y-Z-axis robot as early as 1991. Even back then, mdp, maxon motor's sales company in France, was on board. Therefore the drive specialist was contacted again during the first development phase of StarMax, to clarify the most important questions: How can precise movement be achieved on all three axes? How can the reagents be pipetted fully automatically? "In the end, mdp used their vast experience to adapt their standard products to match our requirements," says Jean-Francois Gelin, Project Manager Innovation and R&D at Stago. "Additionally mdp and maxon contributed their specialized know-how and gave us valuable tips."

**Easy motor control**

The cooperation has now become so close that mdp assembles the complete conveyor system for the pipette racks in its own production facilities in Neyron and ships it to Stago for final assembly. Various types of the A-max DC motor by maxon are used for the movements of the rack. The diameters vary between 16 and 26 millimeter. The DC motors are highly dynamic and easy to control. Additionally mdp installs matching planetary gearheads to generate the required torques. The maxon sales company therefore is not only a drive specialist, but also an expert in the fields of mechatronics and automation. "Our company slogan – Motors, Systems, Solutions – reflects that," says Alain Pontille, Managing Director at mdp. "We work very closely with our customers and jointly create solutions that make their products an economic success."

This worked very well for Stago. "When we started developing hemostasis analysis machines, hardly anybody believed in our success," says Jean-François Gelin of Stago. Today the company has more than 2,100 employees and delivers its high-end products to more than 110 countries. ■■■

Thierry Bournier is setting the belt tension.

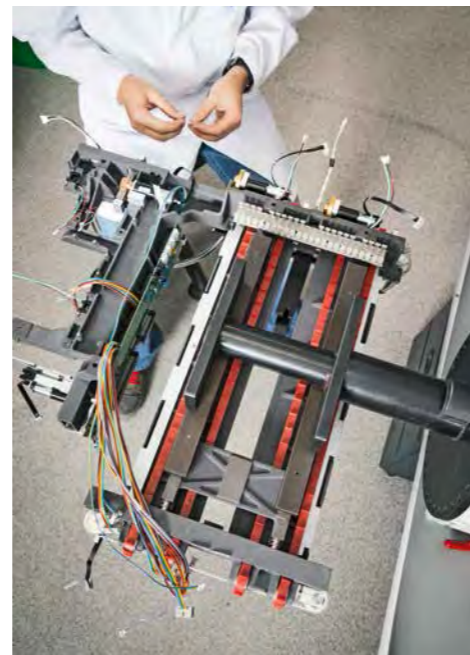

Photos: maxon motor ag / Daniel Gilliet

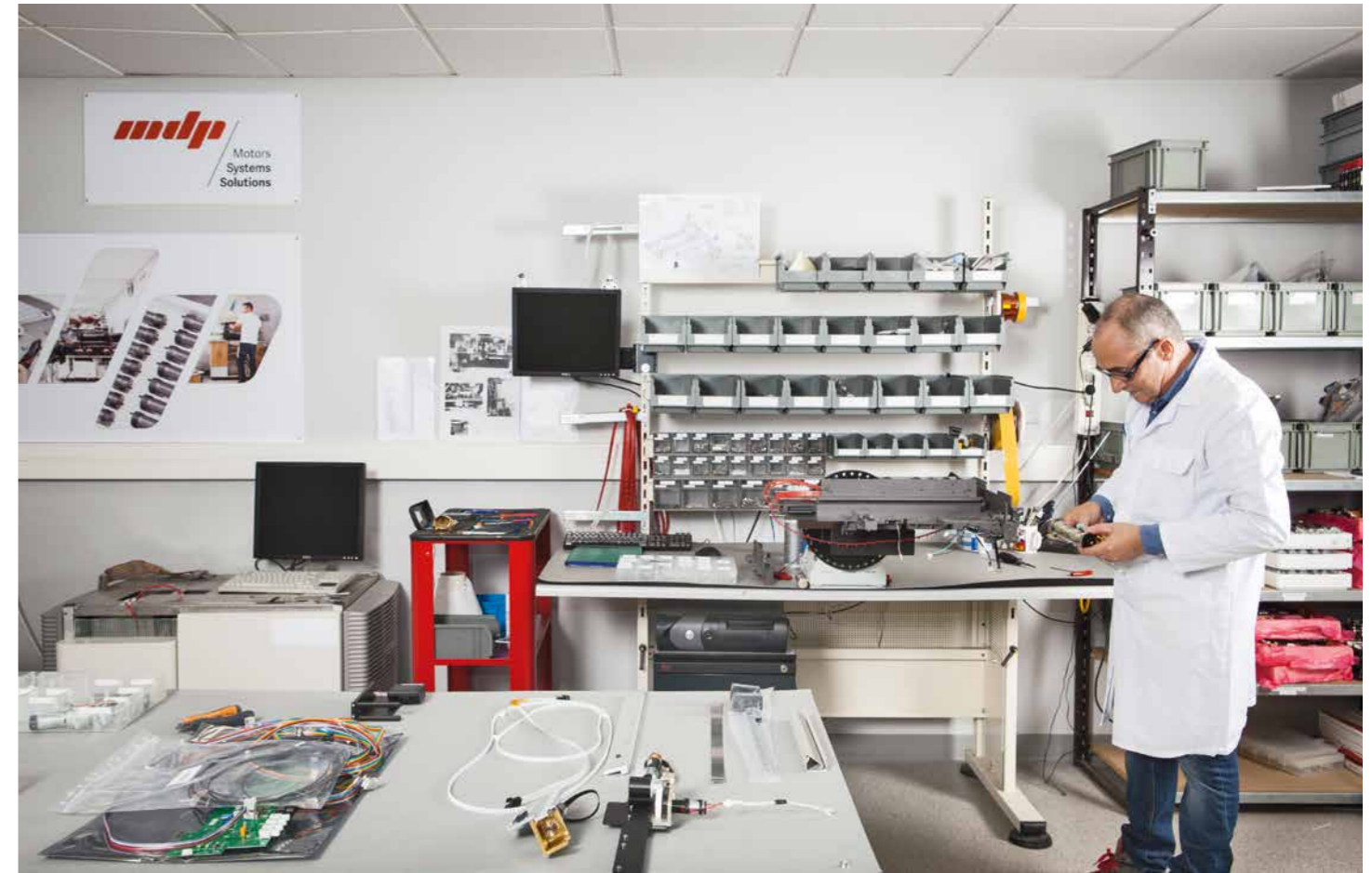

At the mdp workshop in Neyron, Thierry Bournier begins the assembly of the transport unit for the Stago analytic device.

**Sales and parts production of maxon motor**

In the fall of 2014, mdp officially became part of the maxon motor Group. Previously, the company was sales partner for France. mdp was founded in 1982 as provider of micromotors of various manufacturers. The company later grew significantly through the sales of standard products that could be shipped quickly, as well as by providing a call center for technical support. Today 41 employees work at the headquarters in Neyron, outside of Lyon – in sales, development and in production, among other departments. mdp does not only offer its customers drives, but instead manufactures complete drive systems upon request, like in

Stago's case. This makes mdp one of the six global production sites of maxon motor. The other sites are in Switzerland, Germany, Hungary, the Netherlands and South Korea.



# 600 meters below the ice

The kilometer thick ice of the Antarctic holds many secrets. For decades, scientists have researched the history of global climate by ice-core drilling. Such a team is the Research Organisation British Antarctic Survey (BAS). With a new technology the researchers can drill 8 times faster in to the ice.



Julius Rix, Ice Core Drilling Engineer:  
“A lot of ice drill sites tends to be flat and wide but the scenery there is always phenomenal.”

Photos: BAS, maxon motor ag



**maxon EC 45**  
Ø 45 mm, 250 W, brushless;  
combined with modified  
GP 52 planetary gearhead

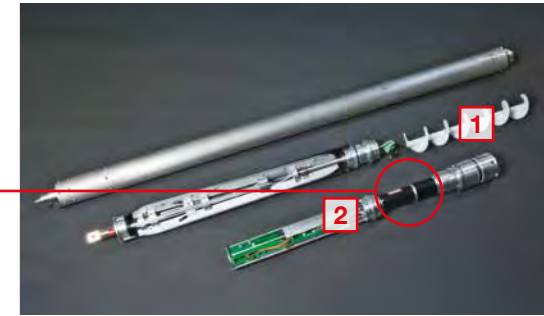

- 1 Chipping spiral
- 2 Motor controller
- 3 Spinning outer barrel
- 4 Cutter
- 5 Fixed chipping spiral

**T**he British organisation has five research stations in the Antarctic, five aircraft, two research ships and a multitude of scientists who do research in the perpetual ice. BAS is the world leading centre for polar research and expertise, addressing issues of global importance.

The Ice Dynamics and Palaeoclimate Team developed a new technology (RAID=Rapid Access Isotope Drill) for ice-core drilling. A technology which makes it possible to penetrate much quicker in to the ice. Conventional ice-core drilling takes a long time. The 3.4 kilometer deep hole at Dome Concordia in the eastern Antarctic, took for example, 5 years to complete. 800,000 year old ice was retrieved; until now the deepest insight into the history of the Earth’s atmosphere.

However, sometimes ice-cores from such deep holes do not produce good results, i.e. if the ice-core has been taken from the wrong place, explained Julius Rix, Ice Core Drilling Engineer at BAS. According to Robert Mulvaney, Scientific Leader of the Research Team, before drilling a deep ice-core, it will be possible to drill several small cores of approx. 600 meters depth, with the new technology, and bring them to the surface for analysis. Drilling to this depth takes about 7 days, with conventional drilling 2 months. The thickness of

the ice and the geothermal heat indicate if it is worth drilling deeper. “It’s all very exciting as nobody before has tried to drill holes in the ice of the Antarctic so quickly” declared Mulvaney enthusiastically.

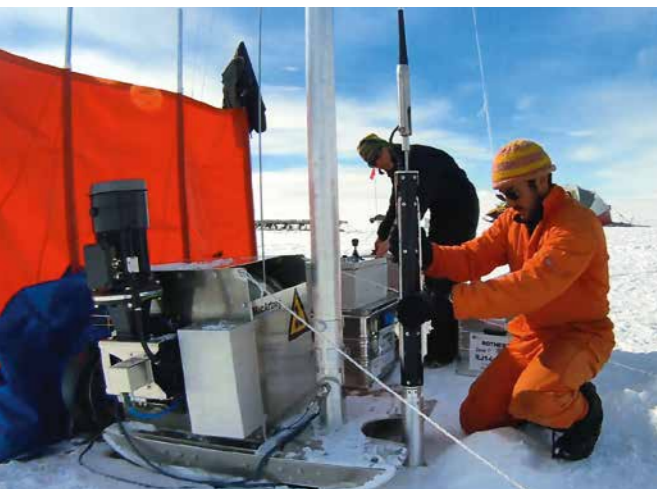

With the new technology, it is possible to prepare for deep drills by first making several drills at a shallower depth of 600 meters and transporting the ice samples to the surface.

**Standard Product in the Antarctic**

„It proved to be difficult to find a powerful small motor for our application“, said Rix. Therefore BAS asked maxon motor uk about a strong motor with high torque. It should be able to vary the speed of the drive at a constant torque. One prerequisite was also the size – the smaller the better – as the drive must fit into the relatively small drill, keeping in mind the harsh environmental conditions which the drive system has to withstand. The maxon engineers recommended the maxon EC 45 with 250 Watt and a GP 52 planetary gear. A standard product! The first drilling tests showed that the standard product could withstand the high vibrations and low temperatures. Only some small modifications were required. “maxon really helped us with selecting the right motor and making test motors available to us in advance” said Rix. ■

**Never before was it possible to drill ice holes into the Antarctic so fast.**

The video to the article can be found at: [drive.tech](http://drive.tech)

Julius Rix in the cold room shows some ice cores, who are ready for analysis.



# Drive solutions for the automotive industry.

Compact, low mass and high efficiency.

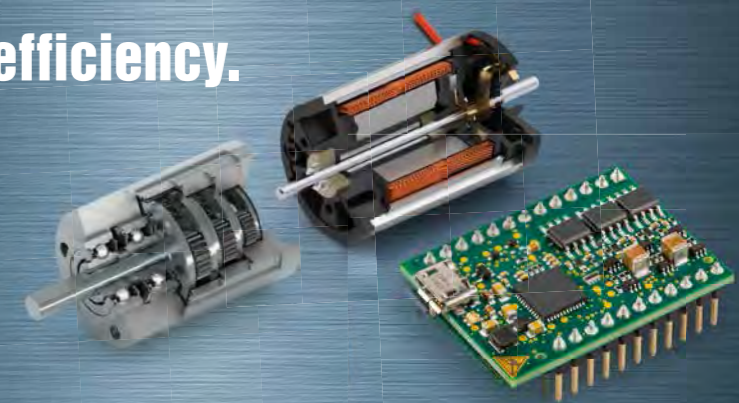

[automotive.maxonmotor.com](http://automotive.maxonmotor.com)

**maxon motor**  
driven by precision



Unstoppable! With "gotthard," the AMZ Racing Team took a lot of trophies in 2016.

Photos: AMZ

# Under power: from "furka" to "gotthard"

From 0 to 100 km/h in 1.513 seconds – that's a new world record for electrically powered vehicles. It was set by AMZ's "grimsel" race car in June 2016. Their latest machine bears the name "gotthard."

The project is backed by the Academic Motor Sports Club Zurich, founded in 2006 by students of ETH Zurich. Every year, the club develops a prototype for the various Formula Student events all over Europe. 130 teams from over 30 countries attended this year's contest on the Silverstone racetrack.

After three cars with combustion engines, AMZ has been building fully electric cars since 2010. Seven of the zippy vehicles have been built to date, each named after a famous Swiss mountain pass. This year's car, the 10th from the AMZ workshop, bears the name of the Gotthard pass. "gotthard" weighs a mere 172 kilograms. With 216 horsepower, the power-to-weight ratio is 1.26 HP/kg, a value that exceeds even supercars and gives the car its enormous acceleration.

### maxon drive for DRS

maxon drive systems play a small but important role in "gotthard's" efficiency. They are used in what's called the Drag Reduction System (DRS). As the name says, the DRS's job is to reduce the drag on the car's rear wing and improve its efficiency.

The rearmost element of the wing is controlled by a lever system. A brushless maxon EC 22 motor combined with a GP 22 HP planetary gearhead and an encoder is used to

adjust the wing. The drive unit is hidden inside the main element of the rear wing.

The DRS can have two different states. The flap is either open or closed, depending on which section of the circuit the car is currently on. The closed position is used on most

The rear wing reduces the car's drag. It is controlled by maxon motors.



maxon EC 22  
Ø 22 mm, 100 W, brushless





Acceleration and weight are being optimized continuously so that excellent lap times can be achieved with 216 horsepower.

of the track, especially in the turns where the rear wing exerts the most downforce. The higher downforce increases the grip of the tires, which allows the car to go faster in the turns. On the straights, the goal is to reduce air drag as far as possible to enable a higher top speed. Here the second, open state of the DRS is used.

By minimizing the drag, the car also requires less energy on the straights.

### 0.2 seconds to turn

According to Philip Dalla Palma, a focus student in the project and in charge of the front and rear wings, the maxon drive system met the requirements perfectly. "Our requirements on the power train are quite simple really: The DRS flap needs to be turned within 0.2 seconds. The shaft of the planetary gearhead is exposed to a maximum torque of 1.7 Nm, and the shaft must be able to rotate by 165 degrees."

There are no obstacles to future victories and world records. In August, the AMZ team and "gotthard" took the trophy for the overall victory of the Formula Student competition in Austria. Congratulations!



Acceleration and weight are being optimized continuously so that excellent lap times can be achieved with 216 HP.

Photos: AMZ, Ingo Höhm

## The electro racers of the AMZ team

**2016 "gotthard"**  
AMZ's latest car  
4 motors  
Power: 159 kW  
Weight: 172 kilograms



**2015 "flüela"**  
4 AMZ hub motors with up to 20,000 rpm  
Power: 148 kW  
Weight: 173 kg  
Acceleration 0–100 km/h: 1.9 s  
Top speed: 120 km/h



**2014 "grimsel"**  
The AMZ's lightest vehicle  
4 AMZ M4 hub motors  
Power: 148 kW  
Weight: 180 kg  
Acceleration 0–100 km/h: 1.513 s  
Top speed: 120 km/h



**2012 "umbrail"**  
2 AMZ M2 electric motors made in-house  
Power: 80 kW  
Weight: 170 kg  
Acceleration 0–100 km/h: 3.2 s  
Top speed: 120 km/h



**2013 "julier"**  
First vehicle with 4WD  
4 AMZ M3 motors  
Power: 70 kW  
Weight: 180 kg  
Acceleration 0–100 km/h: 2.6 s  
Top speed: 120 km/h



**2010 "furka"**  
First electric race car  
2 DC electric motors with lithium polymer battery cells  
Power: 60 kW  
Weight: 227 kg  
Acceleration 0–100 km/h: 3.8 s  
Top speed: 111 km/h



**2011 "novena"**  
First vehicle using electric motors wound and manufactured in-house  
Power: 70 kW  
Weight: 181 kg  
Acceleration 0–100 km/h: 3.4 s  
Top speed: 120 km/h

# On the heating of motors in hand-held tools

There are several factors that cause DC motors to become hot – something that should be avoided especially in hand-held devices. Oversizing the motor can help. However, there are other options as well.

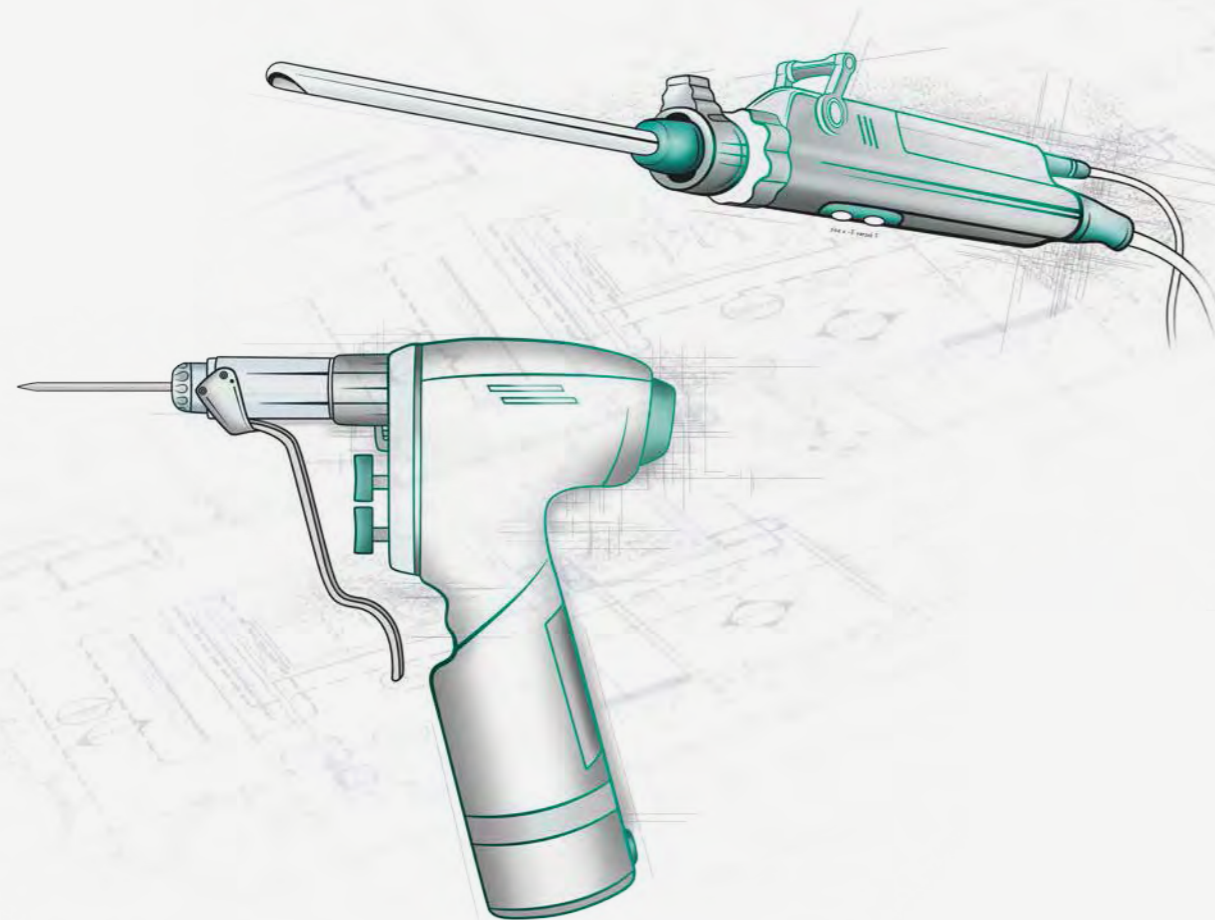

**Urs Kafader** has supervised technical training at maxon motor for more than 20 years. He runs training sessions on the technology and use of maxon products for employees at the maxon headquarters in Sachseln, for the international sales network, and for customers. He holds a Ph.D. in physics as well as an MBA in production science. He began his career at the Laboratory for Solid State Physics at the Swiss Federal Institute of Technology, Zurich.

Photos: maxon motor ag

**W**hen a DC motor is operated close to its nominal torque, it may become very hot. In continuous operation, the winding can reach temperatures up to 155 °Celsius, which results in a housing temperature around 120 °Celsius. No surgeon would want to work with a tool like that, not even at half the temperature. What can be done about it?

Leaving friction aside, there are two main sources of loss that cause a motor to heat up: electrical heat and iron loss.

## Electrical heat losses

Electrical heat loss depends on the load torque, which is proportional to the current. The loss increases with the square of the current. High currents close to the nominal current cause temperatures that are unsuitable for contact with human skin. However, if a motor is running at only half its nominal current, then temperatures are more moderate (usually under 50 °Celsius) and suitable for contact with human skin. For motor selection, this means: Oversize it!

The above considerations are based on continuous operation, where the maximum temperature is only reached after 10 minutes. Hand-held devices, however, are usually run in intermittent operation with a duration of 30 minutes and more. This means that we still have to consider continuous operation, but based on the effective load current (RMS, the root mean square) over the entire load cycle. The mean heat build-up is

equivalent to that caused by continuous operation with the RMS load torque.

## Iron losses

Iron losses depend on speed. Eddy current losses increase with the square of the motor speed and heat up the motor whenever it's running, even without load. For hand-held devices, this can become a problem with grinding and milling tools that run at speeds of several tens of thousands of revolutions per minute (rpm). Such high-speed motors need to be specially designed to minimize eddy current losses. They are typically built with fewer magnetic poles, ironless windings, and ultra-thin iron plates with a low hysteresis in

**Temperatures are more moderate if a motor is running at only half its nominal current.**

Winding and housing temperature in relation to the motor current (motor in continuous operation)

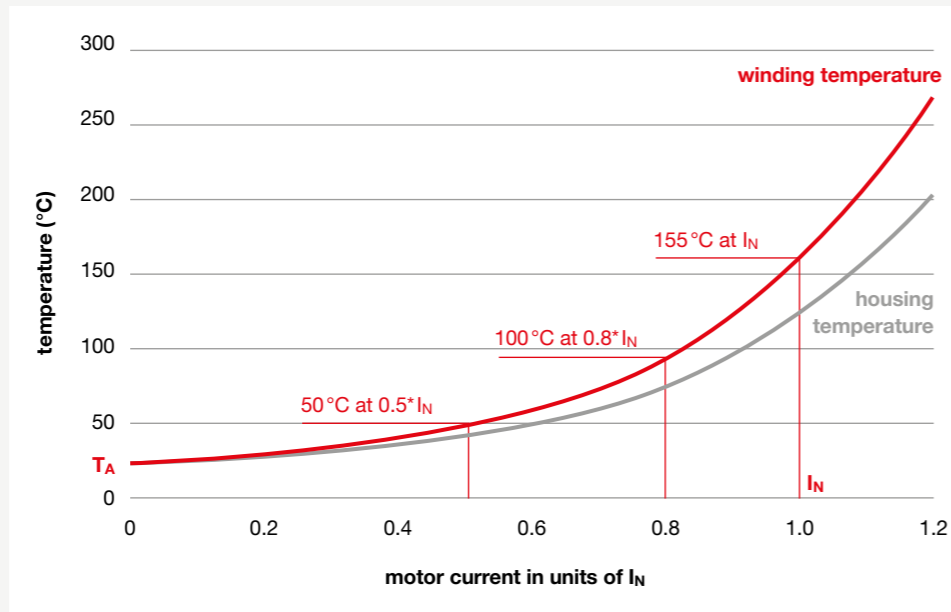

the magnetic return. The maxon ECX SPEED program combines these special characteristics. With their long design and diameters from 16 to 22 millimeters, these brushless DC motors are perfect for hand-held devices that operate at speeds significantly upward of 10,000 rpm.

**PWM control and inductance**

However, heat generation in a motor depends on more than torque, speed, and construction. It also depends on the design of the pulse-width-modulated (PWM) controller and the setting of the control parameters. A customer recently complained to us about their hot motor (80°Celsius and more) even at idle. Detailed analysis revealed that the control and the supply voltage were an important factor.

Ironless windings have a very low inductance, which results in a low electrical time constant. As a result, the current responds very rapidly to changes in the voltage – which is desirable if dynamic behavior is a design goal. However, if such a motor is controlled with a PWM output stage, which is

what most controllers have, then the motor current follows these fast voltage changes. This can cause a large current ripple. While PWM voltage and current ripples have no effect on the mechanical behavior of a motor – the motor basically “sees” only the mean current and voltage – peak currents in the ripple cause the motor to heat up. In a similar way, rigid control loop settings cause strong, rapid current responses with a corresponding heat build-up. Possible countermeasures to minimize current ripples are:

- Reduce the supply voltage of the PWM power stage as far as speed requirements and the application type permit.
- Increase the PWM frequency to give current ripples less time to develop.

It often helps to reduce excessive supply voltages to a minimum.

- Install an additional inductance (motor choke) in series with the motor connectors. This increases the electrical time constant and attenuates the current response. This last option is not very attractive, as it increases cost and requires extra installation space.
- Select soft control parameters.

maxon controllers account for the low inductance of maxon DC motors. They operate at high PWM frequencies between 50 and 100 kilohertz and have sufficient additional inductance for most motors and situations.

By the way, our customer’s temperature problem was easily solved: All they had to do was to swap their oversized controller for a maxon ESCON controller. The ESCON solution has a lower nominal power (while still sufficient of course). It operates at a higher PWM frequency than the existing controller and has a larger built-in motor choke. This would already have helped a lot.

However, it was possible to lower the temperature even further by decreasing the supply voltage until it was close to the required minimum.

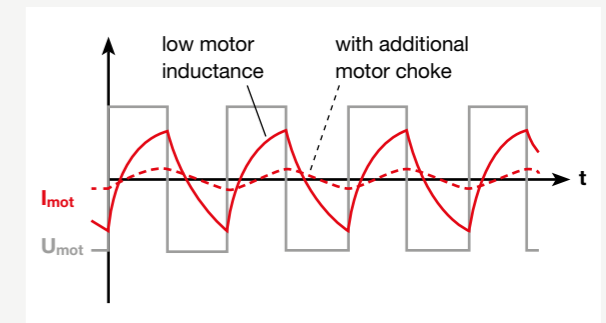

Current ripples at standstill with and without additional inductance (concept illustration). The mean current (i.e., the mean torque) is zero in both cases, but the heat build-up in the motor differs.

It is important to avoid excessive heat build-up in motors, especially those in hand-held surgical tools.



maxon ECX-Speed 22 brushless, sterilizable



maxon servo controller Esccon 50/5



Photos: maxon motor ag, Fotolia/Bergringfoto

# A piece of freedom

Every day, Othmar Zoll uses a handbike that he upgraded with the maxon bike motor. Without any problems and with a smile on his face, he can now go up steep rises that used to be insurmountable obstacles.

The driveway was always too steep for Othmar Zoll and his handbike. Even with an electric motor he was unable to go up the last few meters to his house in the south of Switzerland. The drive simply didn't have enough torque – until he discovered the maxon bike motor.

Othmar is a retired interior designer and artist, 66 years old and athletic. Even though he has been in a wheelchair for half his life, he isn't letting that stop him – especially not now that he discovered the handbike. In a few simple steps, he can attach it to his wheel-

chair and drive it with his arms working the hand cranks.

## “It's simply a lot of fun”

He initially had a model without a motor and added electrical support later. Since the fall of 2015, he is using a bike motor from maxon, the Bikedrive. He was able to install the kit – motor, battery, and Powergrip – by himself. Now even that last rise to his vacation home is no longer a problem. “To me, the motorized handbike is a piece of freedom,” says Zoll.

Photos: maxon motor ag / Philipp Schmittli

“I can reach all kinds of places, I’m out and about in the fresh air, and it is all a lot of fun.”

**Health benefits**

Zoll found the Bikedrive more or less by chance. A bicycle dealer pointed out the new motor to him. He then contacted maxon, and a little later he was able to install the completely assembled wheel at home. Now he is amazed that he’s not seeing more people in wheelchairs using a handbike. “It would do a lot of good to many people. With a motor like that, there are no downsides,” Othmar says. “I can go long distances, keep up with other cy-

clists, and work out my shoulders at the same time.” The electrical support ensures that his joints are not overexerted – an important point. Many people in wheelchairs suffer from shoulder problems caused by excessive strain. Zoll says: “For me, the handbike is also a therapeutic aid. I haven’t had any problems in a long time.”

**On the road even in winter**

Othmar Zoll is a creative person. He likes to paint, practices stone carving, and cooks. When he leaves the house, his handbike is a constant companion. His daily routine in-

cludes 20 to 40 kilometers. He rides in the hills of central Switzerland, along the rivers and lakes, even in winter. He calls it independence. On top of that, his handbike has another positive effect: “When people see me riding it, they know that I’m active and can take care of myself despite being in a wheelchair. This makes them feel less awkward dealing with me – we’re at eye level, so to speak.” He smiles, turns around, and leaves. ■

[maxonbikedrive.com](http://maxonbikedrive.com)

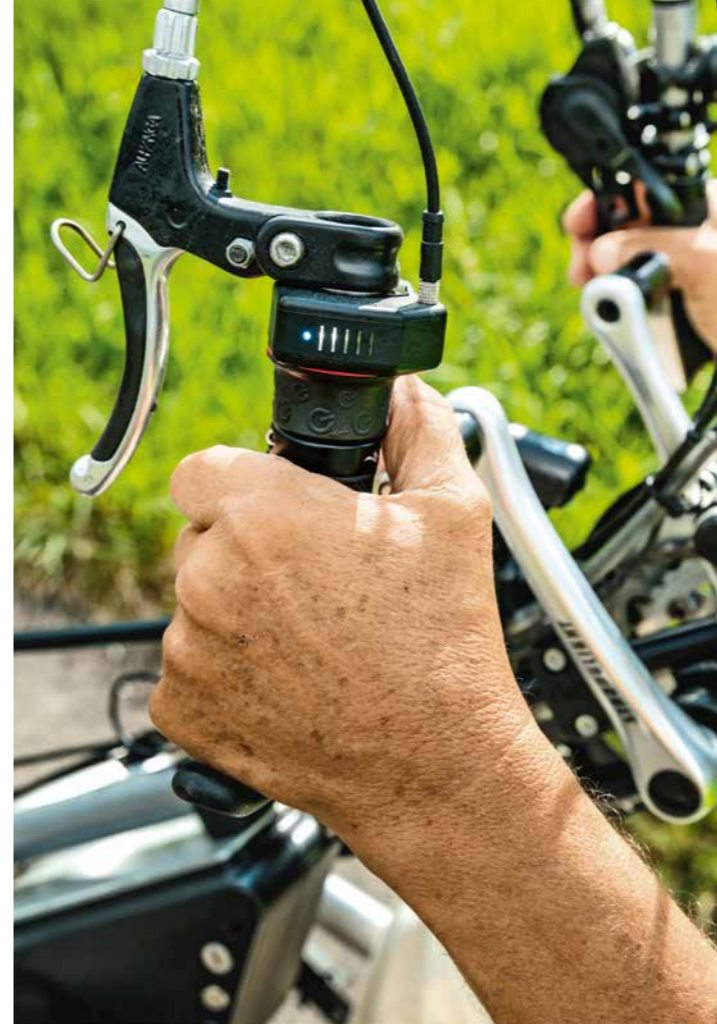

The Bikedrive retrofitting kit consists of a motor, a battery, and the Powergrip. It fits perfectly into Othmar Zoll’s handbike. Steep driveways are no longer a problem.



Photos: maxon motor ag / Philipp Schmidli



# Where is this image detail hidden?

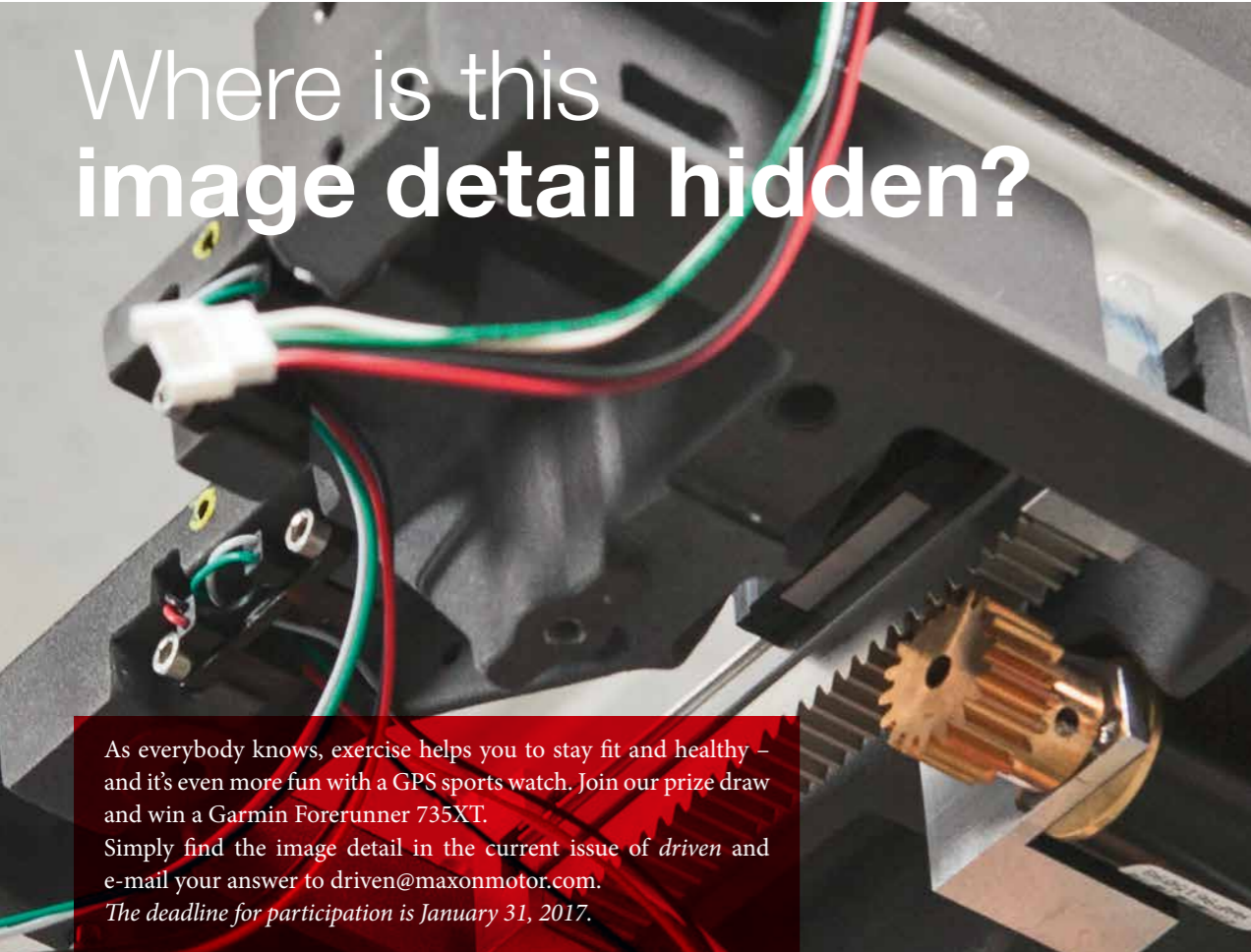

As everybody knows, exercise helps you to stay fit and healthy – and it's even more fun with a GPS sports watch. Join our prize draw and win a Garmin Forerunner 735XT. Simply find the image detail in the current issue of *driven* and e-mail your answer to [driven@maxonmotor.com](mailto:driven@maxonmotor.com). The deadline for participation is January 31, 2017.

Employees of maxon motor are not eligible to participate. There will not be any correspondence in regard to the contest. All decisions are final.



With its integrated activity profiles, the Garmin Forerunner 735XT sport watch is suitable for a wide range of activities, like running, cycling, swimming, crosscountry skiing, kayaking, trail running, hiking and power lifting. It is Garmin's first watch with the Elevate technology for heart rate measurement on the wrist.



**What aspect of this topic do you find particularly interesting?**  
Let us know on our Twitter channel @maxonmotor or contact [driven@maxonmotor.com](mailto:driven@maxonmotor.com)

## Imprint

**Published by:** maxon motor ag  
**Editors:** Stefan Roschi, Anja Schütz  
**Copyright:** © 2016 by maxon motor ag, Sachseln. Reprint or reproduction only with express written permission.

**Realization:** Infel Corporate Media  
**Project manager and editor:** Bärbel Jördens  
**Design:** Peter Kruppa (Art Director), Marina Maspoli  
**Proofreading:** Claudia Marolf  
**Printing:** Druckerei Odermatt AG

**Frequency of publication:** Twice per year  
**Languages:** German, English, Chinese  
**Print run:** 10,500 (DE), 4,500 (EN)

**driven online:** [magazine.maxonmotor.com](http://magazine.maxonmotor.com)

Photo: maxon motor ag / Daniel Gillet



# Whatever you need. For missions to strange planets.

maxon DC motors and gearheads are being used in the ExoMars rover, which is going to fly to Mars in 2020. The drives are especially efficient and robust. They withstand vibration, impacts, and extremely high and low temperatures. Whatever your drive technology needs may be, maxon motor is the partner by your side.

[aerospace.maxonmotor.com](http://aerospace.maxonmotor.com)



**maxon motor**  
driven by precision

ExoMars is a partnership mission between the European Space Agency, ESA, and the Russian space agency, Roscosmos. ©ESA

**drive.tech** by maxon motor

# Even more drive technology.



Get inspired, improve your knowledge.  
Stay tuned and visit **drive.tech** now.