

# DRIVEN

by  
maxon motor

## Ready for take-off

— Electric drives 30,000 feet  
above sea level p. 18

— These aviation trends await  
us in the future p. 30



Focus \_\_ Insights

The long road to take-off.

10



26

Interview

Aerospace project manager Robin Phillips on electrical systems in passenger planes.

30



Trend \_\_ Future technologies in aviation

From drone taxis to supersonic jets.



18

Focus \_\_ Aviation

Airplanes contain hundreds of electric motors.

24



Application \_\_ Inspection robots

A small inspection robot scales tank walls and airplane fuselages.



29

Heroes of this issue

These electric motors and drive systems power our magazine.

22



Infographic

These are the tasks performed by DC motors on board – an overview.

Legal & contact information

Publisher: maxon motor ag
Editorial team: Stefan Roschi, Adrian Venetz
Realization: Infel AG
Project manager: Bärbel Jördens
Design: Peter Kruppa (Creative Director), Marina Maspoll
Proofreading: Franz Scherer
Print: Druckerei Odermatt AG
Publication frequency: Twice annually
Languages: German, English, Chinese
Print run: 10,500 (DE), 7,500 (EN), 2,000 (CH)

Copyright: © 2018 by maxon motor ag, Sachseln. Reprint or reproduction only with express written permission.

driven online: magazine.maxonmotor.com

Follow us



Please see our blog for more exciting news, stories, and technical reports: www.drive.tech

Photos: iStock/Chalabala (cover), iStock/izusek, iStock/Liyao Xie, Getty Images/spooh, SR Technics Switzerland Ltd, Invert Robotics, maxon motor/Philipp Schmidli, Airbus Group, maxon motor, maxon motor/Adrian Venetz, Ypsomed, iStock/RaStudio

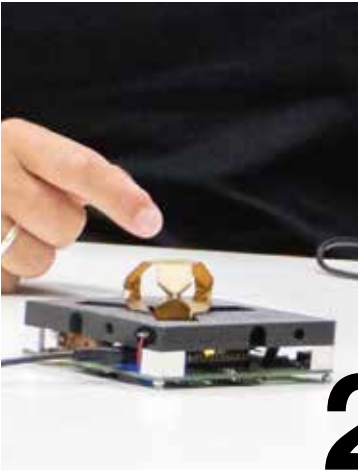

24

**Innovation** \_\_ YEP report

Young engineers are working on the foldable joystick of the future.

36



**Expertise**

maxon expert  
Urs Kafader  
on sensorless  
control of  
brushless motors.



40

**Innovation** \_\_ Insulin pump

Insulin devices and their components need to be absolutely reliable.



**Column**

Airplane toilets:  
Hope dies last.

42

43

**Contest**  
Join & win



Eugen Elmiger,  
CEO maxon motor ag

## How do we fly tomorrow?

An ever-increasing number of people has the means of traveling by air. Prices are at a record low, and planes are becoming ever more efficient – in part due to electric drive systems, which increasingly replace the old hydraulic systems. Several hundred drive systems are installed in every modern long-haul airliner these days. In this issue of “driven”, we show you where they are.

However, what will travel be like in the future? Our editors are presenting five current aviation trends to you, dear reader. In addition, you may learn about the critical features of high-precision insulin pumps. Not least, you can benefit from the knowledge of our experts and learn about sensorless control of brushless DC motors.

You’ve probably already noticed that our magazine now comes in a new layout. I hope you like it as much as the articles!

Happy Reading!



Moment



Photo: NASA



## The comeback hole

Rarely ever has such a small bore hole caused so much joy and excitement: Media worldwide reported about its history and background after it was made on May 20, 2018. This comes as no surprise: The hole is on Mars, in a region called Duluth. It has a diameter of 1.6 centimeters and was drilled by NASA rover Curiosity. After almost one and a half years, the hole represents a long-awaited comeback for the rover. Mechanical problems forced NASA engineers to find an alternative drilling method for taking rock samples. Curiosity, which has been on Mars since 2012, now uses the weight of its arm to drive the drill into the rock.



# 500,000 meters

An A380 contains a total of 500 kilometers of cable. The ongoing trend of replacing hydraulic and pneumatic actuators in airplanes with electrical ones does little to reduce this amount. Engineers are looking for new solutions.

Research at the specialized facility “Innovation in Intelligent Multimedia Sensor Networks” at the Lucerne University of Applied Sciences and Arts is currently exploring potential uses of powerline communication (PLC) technologies in airplanes. The technology uses power lines for data transmission. The idea isn't new: Many households co-opt the power net for data communication. All it takes is a few small adapters plugged into power outlets. For widespread use in aviation, however, powerline technology still requires some advances.



## Training

## maxon uses the potential of its employees

Together with cantonal authorities, maxon motor has launched a groundbreaking project for basic professional training of adults:

A training course to get qualified as automation assembly technician with a Swiss federal diploma.

The first class started this summer.

The participants are eight women over 25 years of age for whom this is their first vocational training.

All eight have been working at the maxon headquarters in Switzerland for several years.

Since several hundred employees have specialized know-how in the assembly of microdrives, but do not have a federal diploma, the people in charge of training at maxon came up with the idea of a special program. It takes two years and consists of technical classes that are held on Saturdays. The general education classes are held via Skype conference. This way, the participants are able to combine work and further qualification. Among other things, maxon hopes that this training program will help more women to qualify for leadership positions. Thomas Müller, head of professional training at maxon: "Over the next few years, we see a potential of 100 to 200 people taking this course" – which, by the way, is open to other companies as well.



Julljana Mitreska (left) and Merita Lluhani are among the eight maxon production employees who recently started their vocational training to become automation assembly technicians.



More about the project:

[www.angus-adventures.com](http://www.angus-adventures.com)

Young Engineers Program:

[www.drive.tech](http://www.drive.tech)



## World record attempt

## First Atlantic crossing with an autonomous boat

**To date, there have been around 30 attempts to cross the Atlantic with an autonomous boat. They all failed. However, chances are that one will succeed in June 2019: A Canadian team is sending not one, but two autonomous sailboats on the four-week journey from Newfoundland to Europe. If the crossing is completed without any human intervention, it will earn a place in the Guinness Book of Records. The team is also working on a third boat for an even more**

**ambitious mission – an autonomous circumnavigation of the entire world. This boat has a propeller and is driven exclusively by solar energy. The project is the brainchild of two adventurers, Julie and Colin Angus. Colin has traveled the Amazon River all the way from source to sea in a rowboat, while Julie is the first woman who rowed across the Atlantic Ocean solo. In addition to having many other projects, the couple owns a boatbuilding company. They are now applying their knowledge for the planned autonomous crossing of the Atlantic Ocean. maxon motor supports this endeavor as part of its Young Engineers Program by providing expertise and discounted products. The rudders of all boats are controlled by a motor-gearhead combination from the modern DCX series. The electrical systems of the sailboats are also powered by photovoltaic cells. In the larger solar boat that is planned to circumnavigate the world, another electric drive will operate a winch that lowers measuring sensors to various depths. According to Colin Angus, the two sailboats for the Atlantic crossing are finished and currently undergoing testing, while the solar boat is still being built. He says: "We are very grateful for the support. It is comforting to know that maxon drives provide the necessary reliability for such an important task."**



NASA

## Mars helicopter flies with Swiss motors

US space agency NASA has announced that, for the first time ever, it will be sending a helicopter to the Red Planet with the upcoming Mars 2020 rover mission. The helicopter will land on Mars attached to the bottom of the rover and perform several autonomous flights during the first 30 days of the mission. The flights will take up to 90 seconds. This is a great challenge: The atmosphere on Mars is so thin that it is comparable to the conditions found at an altitude of 30 kilometers here on Earth. The helicopter therefore needs to be lightweight (1.8 kg) and can carry only small batteries. All of the components therefore need to be extremely energy-efficient. maxon DC motors fit the bill: Six modified DCX-series minimotors with a diameter of 10 mm are in charge of tilting the rotor blades – i.e. they steer the vehicle.

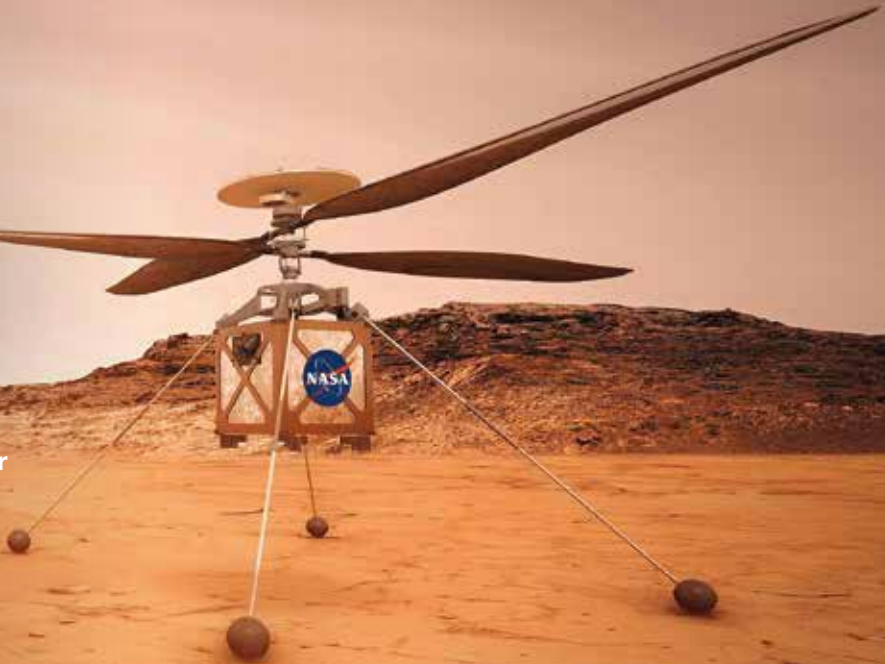

Event

## Cyathlon 2020: maxon is on board again

After the successful Cyathlon 2016, maxon decided to continue supporting the event as partner for its second installment in 2020. An agreement to this effect was signed in late summer. In the Cyathlon, people with physical disabilities compete against each other on obstacle courses – supported by state-of-the-art technical assistance systems. This time, the event will take place over two days: May 2–3, 2020. The first day is for qualifiers, the second for the finals. The teams and pilots again compete in six disciplines: Virtual racing using thought control, bicycle racing with electrical muscle stimulation (FES), dexterity challenges with prosthetic arms, obstacle course with prosthetic legs, obstacle course with robotic exoskeletons, obstacle course for powered wheelchairs.

The Cyathlon is hosted by the Swiss Federal Institute of Technology in Zurich (ETH). With this event, the institute provides a platform for exchange between technology developers, people with disabilities, and the public. In preparation for the main event in 2020, there will be several smaller competitions and device demos all over the world.



For more information:

[www.cyathlon.ethz.ch](http://www.cyathlon.ethz.ch)





# New Products

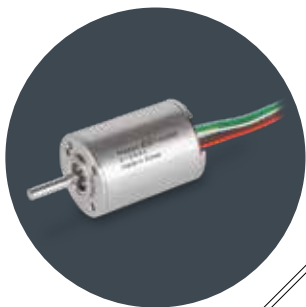

**maxon EC-i 30**  
Ø 30 mm, 20 W,  
brushless

maxon EC-i 30

## Internally controlled

If you need a brushless motor and don't have space for a controller, then the new EC-i 30 is for you. Even though you can barely see it, the motor has integrated electronics for reliable 4-quadrant operation. This enables controlled and dynamic acceleration and braking in both directions. The user can easily control the speed with a potentiometer. The motor is especially suitable for pump and fan drives. A rotor with four magnetic pole pairs delivers torques of up to 100 mNm. Customers who need even more torque will of course find suitable gearheads in the maxon portfolio.



**maxon ECX 6**  
Ø 6 mm, 1.5–4 W,  
brushless

maxon ECX 6

## Can you go even smaller? Yes!

The popular ECX Speed series just gained a new member. The latest addition to the family is its smallest motor to date. With a diameter of 6 millimeters, the brushless DC motor is especially suitable for applications in medical technology. Its ironless winding permits speeds of up to 100,000 rpm. The little power pack is available in two power versions (Standard and High Power) and with a configurable shaft. Like all motors in the X program, it can be combined with gearheads and encoders in the online shop and is ready for shipping within 11 days.



The maxon online shop has more than 5,000 products, selection aids, combination tools, and comprehensive product information:

[shop.maxonmotor.com](http://shop.maxonmotor.com)



# Next stop:

On average, almost 10,000 planes are in the air at any given time. That number is constantly increasing. But many steps are required until a passenger plane's first take-off.

# Take-off





**A Boeing employee during assembly work on a 777. Assembly takes about three months from the first parts to the delivery to the customer.**





Photos: iStock/Fabian Gysel, iStock/zusek



A jet engine is a highly complex machine that consists of about 20,000 parts. Just the design and production of fan blades is a science in and of itself. Compound fiber materials are increasingly being used for this purpose.





Left side: Airplane manufacturers increasingly use riveting robots for the rough fuselage assembly. However, many human hands are still needed for assembling a passenger plane.

The image on the right shows the final assembly of a Boeing 787 Dreamliner.

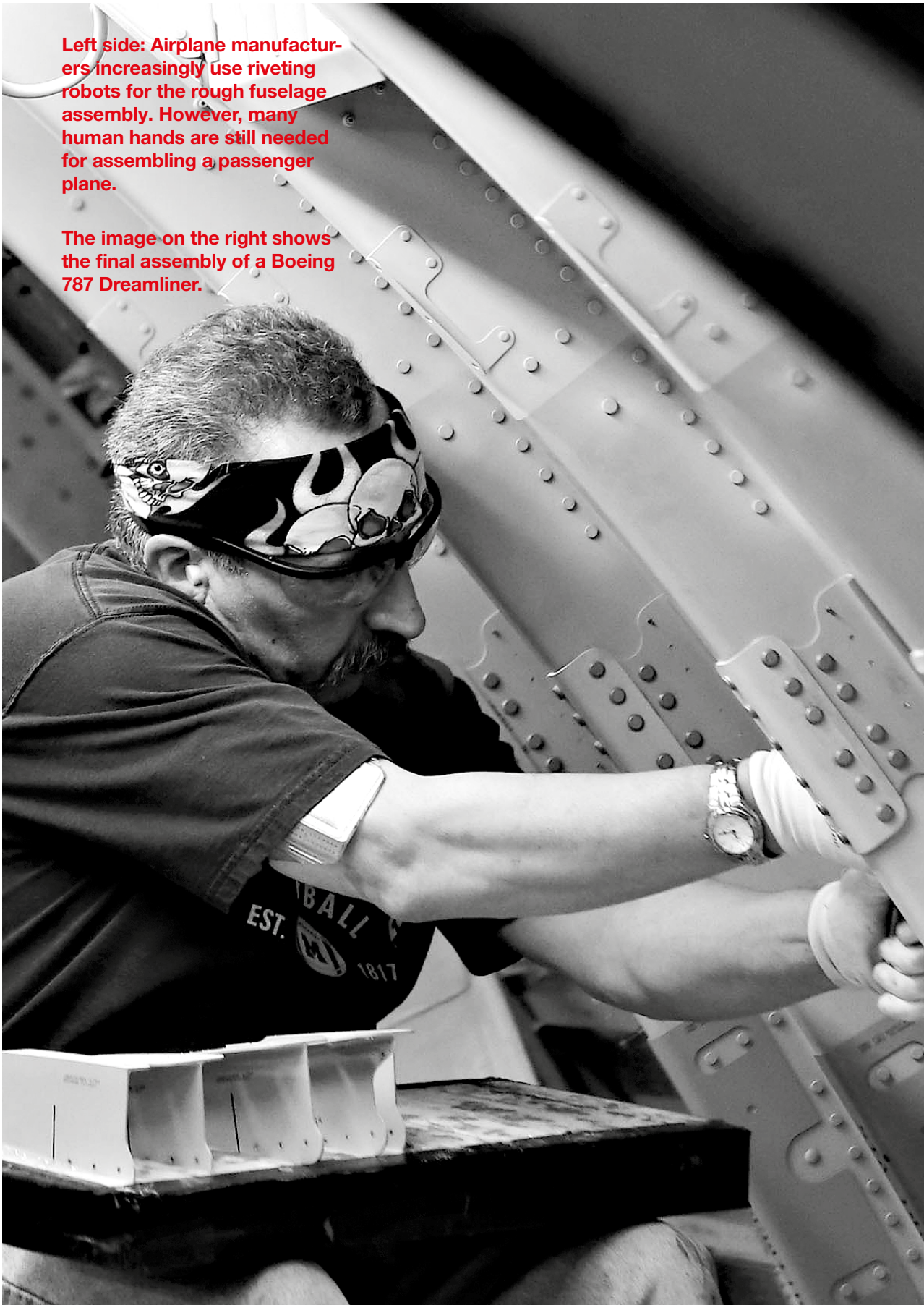

Photos: Getty Images/Bloomberg, Boeing/Bob Ferguson







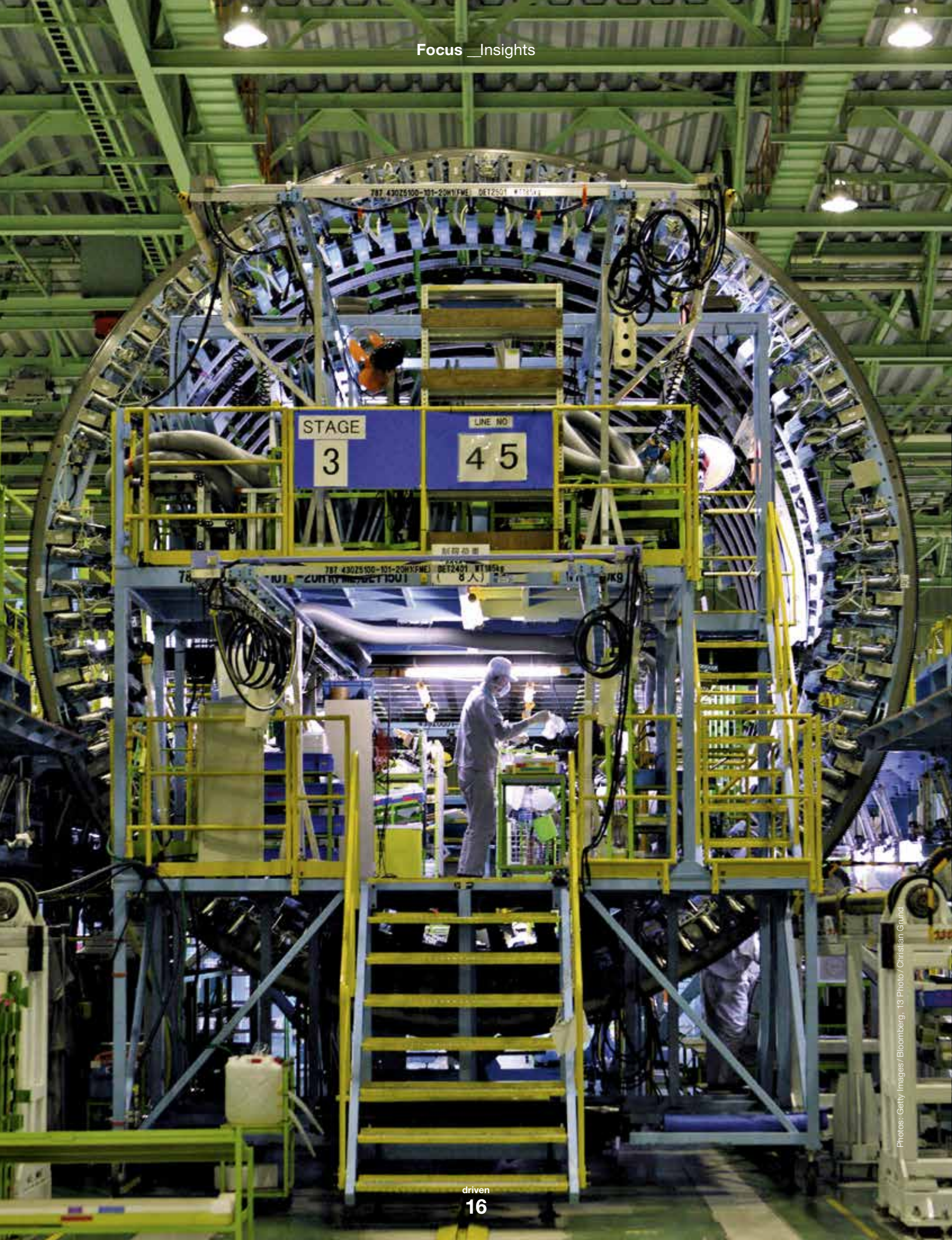

Photos: Getty Images/Bloomberg, 13 Photo/Christian Grund





**Cross-section of a Dreamliner with a diameter of 5.75 meters at a Boeing production facility. The two main airplane manufacturers Boeing and Airbus are steadily ramping up their production, which is currently at a total of around 1,500 machines per year.**

**Bottom: A delivered A330 at the Zurich airport.**



# 10,000 meters above sea level



Photos: iStock/Egnych, iStock/ansommiao



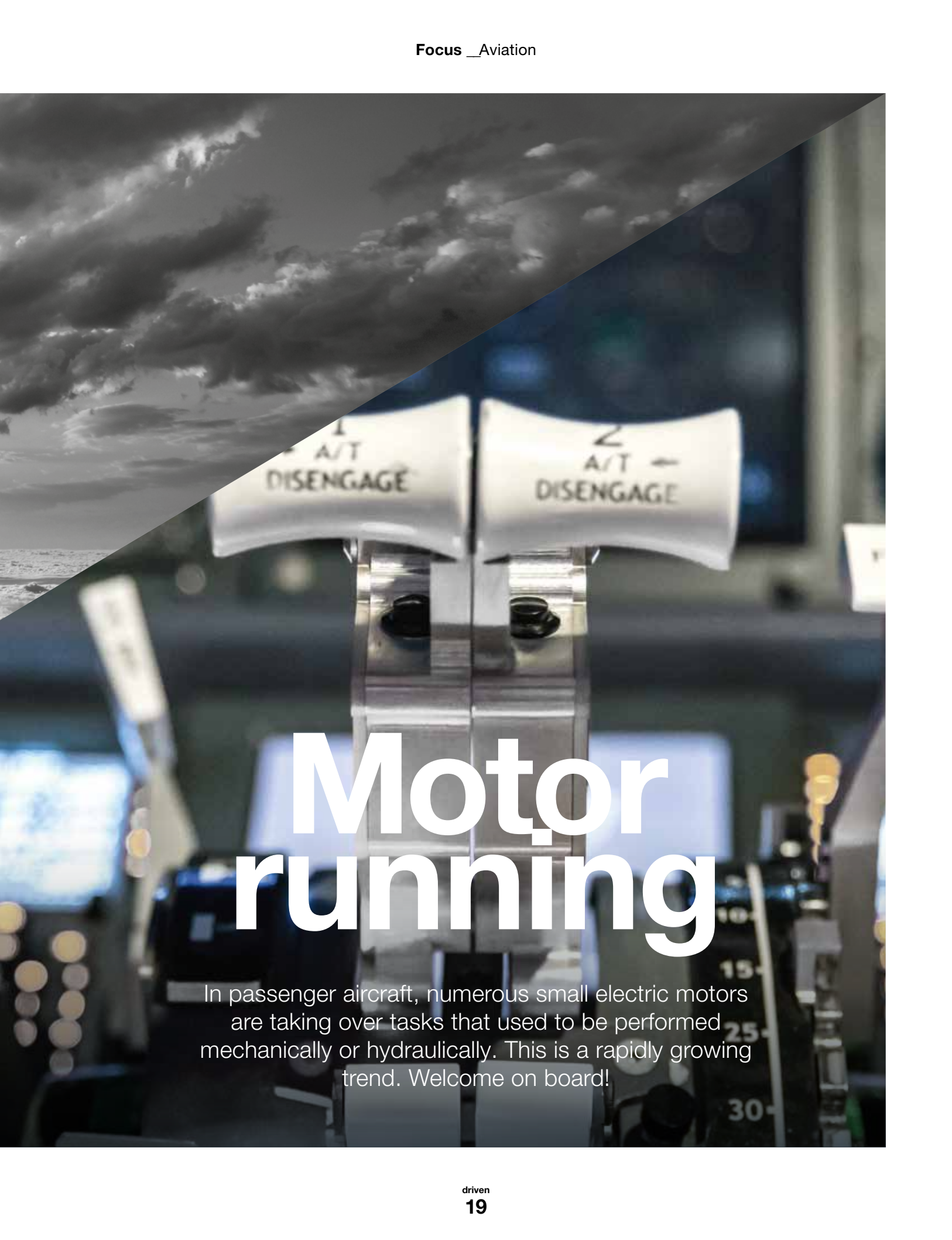

# Motor running

In passenger aircraft, numerous small electric motors are taking over tasks that used to be performed mechanically or hydraulically. This is a rapidly growing trend. Welcome on board!





Electrical actuators are everywhere on board – for example in the air conditioning system, where they ensure pleasant temperatures and fresh air (top). In addition, they are also used in handy closing aids for the overhead baggage compartments.

**W**e've checked in, the smell of kerosene is in the air, a quick look at the boarding pass confirms the seat number. Passengers are standing in the aisle, placing their carry-on bags in the overhead compartments. Invisible to the eye, powerful micromotors assist as a cabin crew member pushes the compartment's lid upward to close it. Welcome on board, and welcome to the invisible world of electric drive systems.

### Automatic aviation systems

The pilot steers the plane to the runway, pushes the thrust lever forward, and takes the machine into the air. His control joystick is equipped with small electric motors that create a force feedback. This lets the pilot know effectively and in real time what is going on at the wings on the outside of the plane. Long gone are the times when the control stick was connected directly to the flight control surfaces via cables. When cruising altitude is reached and the autopilot is activated,

### maxon drives in aviation

maxon has a great selection of standard products at a high level that are easy to integrate into a wide variety of aerospace applications. At the same time, the company offers help with custom solutions and complete mechatronic systems. maxon has been certified under aerospace standard ISO 9100 since 2012. Drives are tested in in-house laboratories for vibration, shock, cold, heat, and vacuum.

the throttle lever moves automatically (auto throttle), controlled by a DC motor.

At the back of the cabin, the plane's air conditioning is working hard to ensure that passengers are feeling well at an altitude of 10,000 meters. Temperature, oxygen, and air are controlled via numerous small valves and actuators, most of them brushless flat motors. The air conditioning system of a Boeing Dreamliner for example contains nearly 50 maxon EC 45 flat motors.



### When nature calls

It's a fact of life that sooner or later, every passenger needs to visit the bathroom. Electric drive systems in the background ensure clean processes, regulating for example the water supply and the flushing. In the future, touchless functions are planned for even more convenience (see page 38).

Leaving the lavatory, an envious glance strays to the business and first-class sections. We get the idea: The more electric motors, the higher the level of comfort. In practice, this can be experienced in the seats. They can be adjusted and even extended to form a bed at the push of a button – electrically driven and automatically. A recent feature is the ability to adjust the seat cushion hardness by changing the air pressure, to make even long-haul flights pleasant. The manufacturer Lantal uses brushless maxon motors for the relevant valve. If sunlight in the face disturbs a nap, the window blind can be lowered by pushing a button. This again is accomplished by – you guessed it right – maxon precision motors.

### Seamless Internet connection

Back in the economy class, passengers at least don't have to go without entertainment. The screens above the seats are extended simultaneously to show safety instructions or movies. For those who prefer to surf the Internet instead, an increasing number of passenger aircraft is equipped with communication antennas that continuously and automatically direct themselves to capture the best satellite signal. Each antenna requires three EC-4pole drives with matching HD gearheads. Then the plane descends for landing, and the landing gear is extended. To ensure it remains extended, a motor-gearhead combination of a DCX 22 and GP 32 HD operates a locking pin. Like so many functions on board an airplane that are powered by electric drives, this too remains invisible to the passengers. Medium and long-haul aircraft contain several hundreds of such drives, and their number is constantly on the rise as higher quality standards permit the replacement of hydraulic or pneumatic systems with electric actuators (see the interview on page 24). At the same time, electric drives are used in new applications that improve the comfort of passengers.

Electrical systems save a significant amount of weight compared with hydraulics. This is why they play an important role in making passenger planes more en-

## The long road to electric airplanes

It will probably take decades before we will travel in fully electrically powered airplanes. While both major manufacturers and start-ups worldwide are working on concepts and prototypes for electric planes, there is no machine on the market yet that could carry several passengers.

Insufficient energy density of batteries is usually the main constraint. It would have to be five times higher to bring even a small passenger plane into the air. This is why many developers focus on hybrid engines that are powered by batteries on one hand and jet fuel or gas turbines on the other.

Nonetheless, there are fully electric projects for microplanes, such as by Joby Aviation or Ampaire. Both companies have announced prototypes and test flights for the coming two years.

Environmentally friendly and cost-effective. Other approaches include more energy-efficient engines and lightweight fuselage construction techniques. Electrical engines won't be available any time soon (see the box), and the traffic in the skies is increasing continuously by 5 percent per year. To keep pollution from increasing at the same rate, tomorrow's planes need to be fast, quiet, and environmentally friendly. Engineers are working on it. ■



Other reports on aerospace in our blog:

[www.drive.tech](http://www.drive.tech)



# Drives above the clouds

Passenger planes contain hundreds of hidden electric actuators. We tell you where they are.

On-board communication:  
Automatic alignment of the antenna  
for clean wifi.

**maxon EC-4pole 22 and 30 BLDC motor, ENC 16 Easy encoder, GP 22 HD and 32 HD gearhead**

Cabin air conditioning: Several maxon drive systems are in charge of ventilation, cooling of electronics, and fresh-air supply.

These include:  
**maxon EC 45 flat BLDC motor**

Landing gear: opening the hatches and locking mechanisms

**maxon DCX 22 L DC motor and GP 32 HD gearhead**

Emergency fuel shut-off valve in the event of fire

**maxon DCX motors**

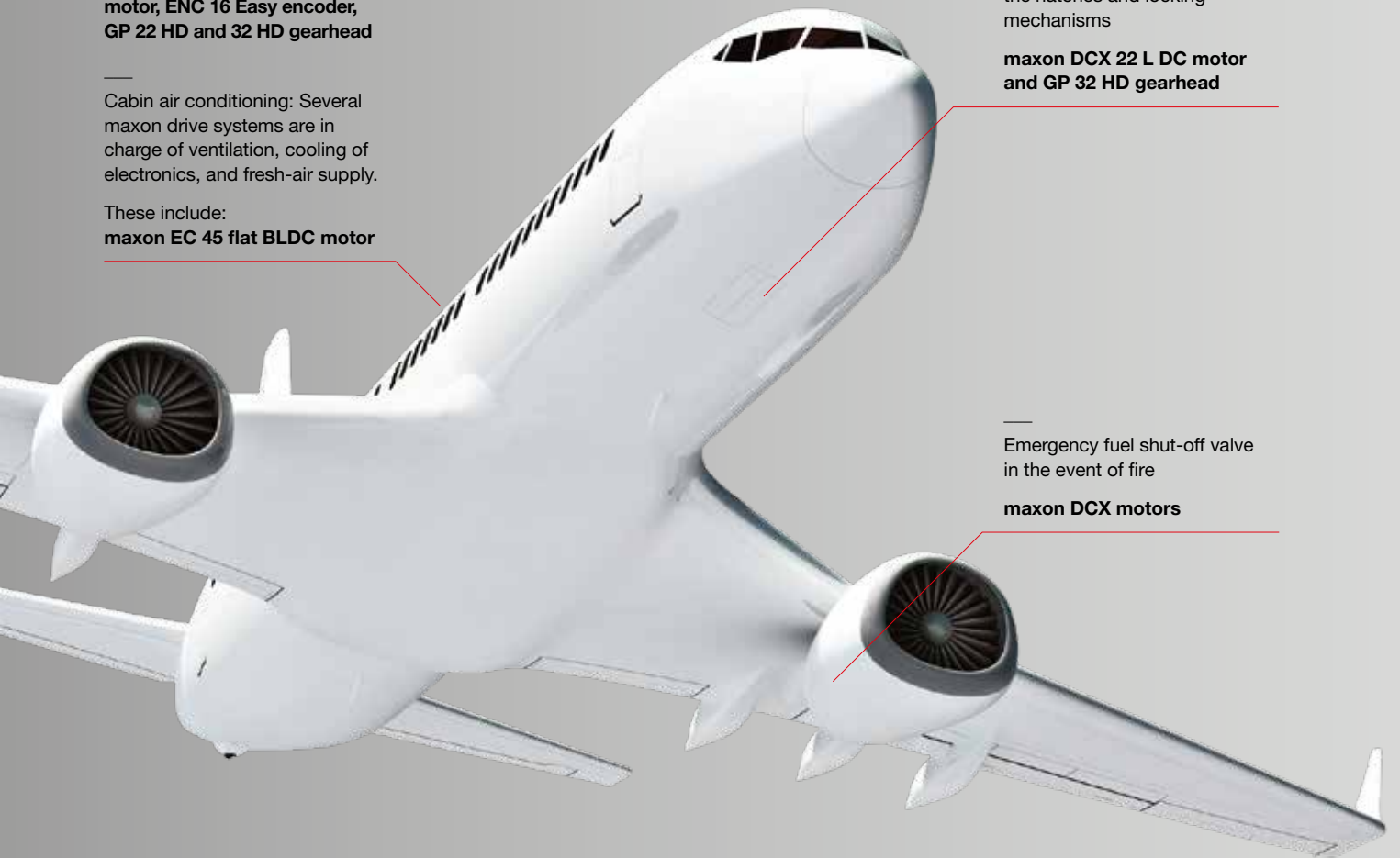



# Infographic

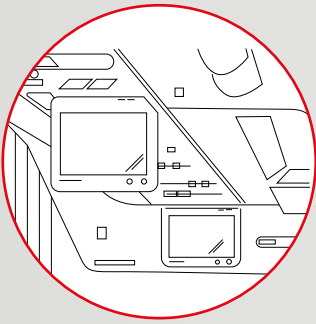

Brushless DC motors are used for extending the displays at the seats.

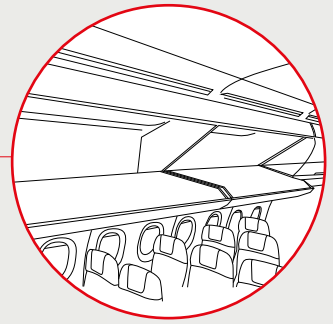

Mechanical support for closing the overhead baggage compartments

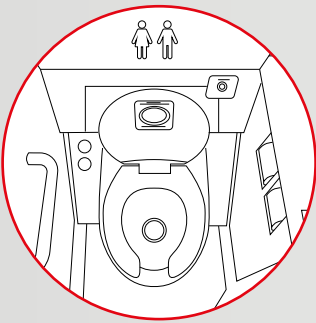
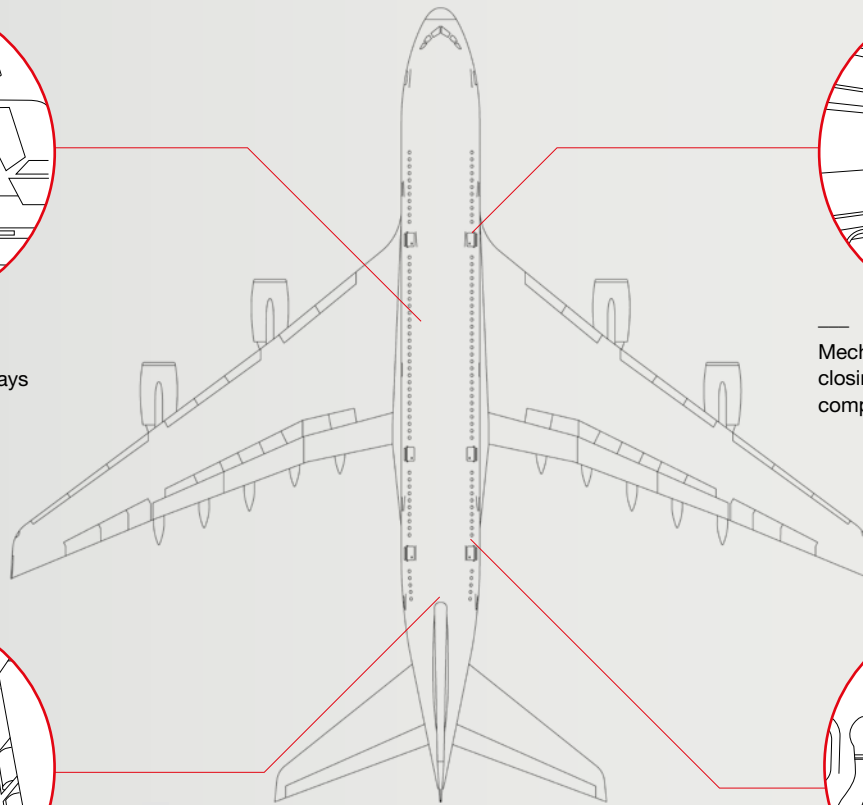

Fresh-water supply and flushing the toilet

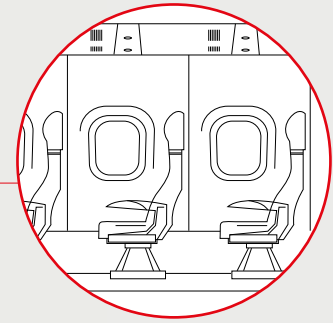

Electrical seat adjustment and personal adjustment of the hardness by pushing a button.

**maxon EC-4pole 30 BLDC motor**

Automatic regulation of the thrust lever

**maxon EC-4pole 30 BLDC motor**

Electrical adjustment of rudder pedals to the pilot's leg length

**maxon EC 22 BLDC motor**

Force feedback for steering control stick

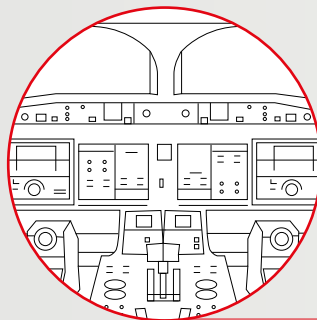

Electric window blinds

**maxon EC-max 16 BLDC motor and GP 16 A gearhead**

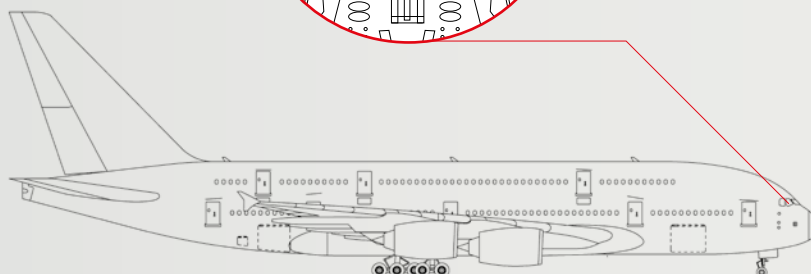



Inspection robots fulfill ever more complex tasks and protect people from injury during dangerous tasks. The little helpers inspect huge milk tanks and climb around the outer shell of airplanes.



This robot uses suction  
to climb walls



**A** lthough many people are afraid that robots will soon take away their jobs, in many cases this is absolutely desirable: for example, when a job involves a high risk of injury. This is also the view of the New Zealand start-up Invert Robotics, which has been developing robots to inspect huge milk tanks since 2010. There are many such tanks in New Zealand, an island nation with a large dairy industry that is inhabited by more cows than people. About a quarter of the country's export revenues is generated by dairy products.

"Our ultimate goal is for nobody to have to work in cramped spaces any longer," says Neil Fletcher, Managing Director of Invert Robotics. This will prevent many accidents, some of which are caused by inhaling carbon dioxide or other hazardous gases.

### The challenge of non-magnetic surfaces

Before the robots were able to take on these jobs, the engineers of Invert Robotics had to overcome a challenge. While there already were robots that were able to move along ferromagnetic walls, a solution for non-magnetic surfaces had yet to be found. "We developed a technology based on suction cups," says James Robertson, Chief Technology Officer of Invert Robotics. The initial solution required a large vacuum pump. However, the engineers improved the design so that a pump is no longer necessary. "The current system is so energy-efficient that the robot remains stuck to the surface for some time even after having been switched off."

Meanwhile, the company has expanded the field of application for its inspection robots to include all types of enclosed spaces, mainly tanks in the food processing and chemical industries. However, the small robots with their suction technology and cameras are not limited to use inside tanks. This was recognized some time ago by the airplane maintenance industry, where finding cracks or other damage to surfaces is a critical task. Time is an important factor, as the plane needs to return to the air as soon as possible. For maintenance personnel, matters are complicated further by the difficulty of moving along the exterior of an airplane's fuselage. These are ideal conditions for Invert Robotics' inspection robot. Its camera delivers high-resolution images of the fuselage to the maintenance personnel. The workers stay on the ground and do not have to brave the heights with lifting platforms or ropes to inspect the plane for damage. This drastically reduces the



More reports  
about inspection  
robots in our blog:

[www.drive.tech](http://www.drive.tech)

inspection time. James Robertson of Invert Robotics says: "No modifications are necessary to use our robots on an airplane."

### Preferred solution from the online shop

The engineers at Invert Robotics are constantly exploring the limits of all the components to find the optimal solution. After all, their robots must function reliably and defy gravity as well as other forces. For the wheel drives, the engineers rely on EC 45 flat brushless flat motors combined with GP 42 C planetary gearheads. These are controlled by ESCON controllers. "We've used maxon drives since the first prototypes and have never been disappointed," Robertson says. He and his colleagues mainly rely on the maxon online shop to configure and order their desired drives. If any questions come up which cannot be answered by the data sheet, maxon specialists stand ready to offer support. ■



**Robin Phillips** has been an aerospace project manager with maxon motor for over ten years and is in charge of the Mars rover projects. The Briton graduated in mathematics and astrophysics. Afterwards he worked in Hawaii at the James Clerk Maxwell Telescope (JCMT), among other positions.



Photos: maxon motor / Philipp Schmiddi



# “The differences are huge”

Hydraulic systems are increasingly being replaced by electric systems in aerospace. Aerospace project manager Robin Phillips knows why – and provides an outlook into the future.

Since 2010, maxon motor has had a dedicated aerospace organization (a business unit by now) that takes care of specialized projects in space and aviation. The best-known ones are the applications for Mars, such as NASA's and ESA's rovers. However, the civilian aerospace applications are just as exciting. They are changing the way airplanes are built.

#### **Robin Phillips, why does maxon need a dedicated aerospace business unit?**

The aerospace industry has special expectations and requirements to its electric drive technology. This is why our developers and salespeople need to be specialists and focus completely on these customer expectations. This is an important part of our success.

Today, eleven people are working full-time on aerospace projects at the maxon headquarters, and about 25 worldwide. Aerospace is still a small market for maxon, but it's growing continuously. The projects fit well with our philosophy – after all, we want to develop products that push the envelope with regard to power and size, at the highest possible quality. These characteristics are in high demand in airplane production.

#### **What other requirements apply to electric drives in airplanes?**

Electric motors need to function reliably across wide temperature ranges from –55 to +85 degrees Celsius, for thousands of cycles. In addition, quality require-



ments are very high because our drives are being incorporated into applications that are relevant for flight safety, such as the safety valves that cut off the fuel supply in an emergency. At the same time, the industry is under heavy cost pressure, as is evidenced by the low flight ticket prices.

**What does this mean for maxon in practice?**

We are providing focused training for our employees, for example in soldering techniques. At the same time, we are automating high quality standards in production processes with the relevant tools and processes. This enables us to reliably deliver large quantities. As an example: We supply about 10,000 drives per year for the Boeing 787, or Dreamliner.

**The aviation industry is currently undergoing a migration from hydraulic and pneumatic systems to electrical solutions. What's the reason for this?**

Hydraulic systems are quite maintenance-intensive, and leaks keep popping up. Their fluid-filled lines are also quite heavy. Electric actuators save weight, because they require only a cable for control. They also require very little maintenance.

**Why hasn't this change happened earlier?**

Electric motors simply weren't reliable enough in the past. However, the continuously increasing requirements in various industries have driven companies like ours to become better and better, so that today, even our standard products meet the highest quality requirements. The differences are huge if you compare our current DCX motors with motors from the 1970s.

**When will hydraulic systems vanish from passenger aircraft completely?**

Smaller planes are already being designed as All Electric Airplanes – except for the jet engines. It will probably take a few decades until this will be the case for large airliners. Flight-critical applications continue to use hydraulic solutions as primary systems, while the redundant systems are already electrical. This is true for example for the actuation of flight control surfaces, or for extending the landing gear. Electric motors come into play only if the primary system fails. However, in the future, even such flight-critical applications will be controlled by two electric drives – so that if the first motor fails, the second motor can take over.

**“In the future, even flight-critical applications will be controlled by electric drives”**



Robin Phillips, Project Manager  
Aerospace at maxon motor

**Over the past two decades, maxon has gathered a lot of experience in space applications, with Mars rovers, satellites, private rocket builders.**

**How does the aviation industry benefit from this?**

The great learning effect is one reason why we go on such missions. The space industry forces us to examine our motors down to the last detail, running test after test to find and eliminate even the smallest weaknesses. Many of these improvements are then implemented in the standard industry solution. As a result, the aviation industry benefits from our know-how gained in space. ■

# Starring



**maxon EC 45 flat  
brushless DC motor**

**maxon GP 42C  
planetary gearhead,  
ceramic-reinforced**

**ESCON Module 50/5  
motor controller**

→ "Inspection robot",  
p. 22



**maxon DCX 10 S  
DC motor**

→ "Mars helicopter",  
p. 4



**maxon DCX 6  
DC motor**

→ "Foldaway", p. 28



**maxon EC 9.2 flat  
brushless  
DC motor**

→ "Insulin pump", p. 36



# 5 Trends in aviation

These are technologies that researchers and engineers are working on.

1



Blackfly

## No stress

After seven years of development, California-based company Opener recently presented its Blackfly electric airplane. The single-seater has already taken to the air successfully on a test flight. The vehicles are intended to “liberate the public from the restrictions of two-dimensional road travel by opening up a new world of unfeathered three-dimensional flight”, the company writes. It describes its flyers as the heralds of a new era of stress-free travel.



Vahana

## No pilot

“Vahana” is a project initiated at an Airbus Group innovation center in Silicon Valley. Its goal is the development of an electric, autonomous vertical-ascent and descent plane to open up urban air traffic routes. According to its developers, Vahana is intended as a “cost-effective substitute for local means of transportation like cars or trains.” Initial test flights were completed successfully in early 2018. The great advantage of this autonomous system: There is no need for trained pilots, which means that the frequency of such flights could be increased enormously.



# 3



XB-1

## Supersonic

Various projects all over the world are dedicated to civilian aviation at supersonic speeds. The US company Boom Technology is currently working on the XB-1, a plane with a top speed of Mach 2.2 (about 2700 km/h) – almost three times the speed of a modern airliner. The company states that Japan Airlines has already pre-ordered 20 planes. The first batch of production units with about 60 seats each could be ready for delivery in 2023. New technologies and materials are intended to make supersonic flight much more efficient and secure than it was the case with the Concorde (1976 to 2003).

Photos: Boom Technology, EPFL/TRANSP-OR/LIV/ICOM, Aviation Aircraft

4



Clip-Air

## Hangers-on

If a train route is used less during certain times, railway operators simply disconnect a few cars to save energy. Would something like this be possible for a plane? Yes, believes a research team at the Swiss Federal Institute of Technology in Lausanne. The revolutionary air transport concept is called Clip-Air. Capsules are attached to a “naked” plane. The capsules vary in number and size depending on the number of passengers or the amount of cargo. The first prototype, which is the size of a private plane, could be ready in about 10 years.

5



Eviation Aircraft

## No emissions

The Israeli company Eviation Aircraft is developing a fully electric airplane with three electrically powered propellers. The airborne taxi, which is equipped with lithium-ion batteries, is designed to carry 9 passengers for a range of about 1000 kilometers, at a speed of 450 km/h. According to Eviation Aircraft, the plane will stand out for its low operating cost, low noise, and zero emissions. A prototype of the flyer is planned to take to the air as early as 2019.



# Foldaway

Exploring the virtual world by touch – made possible by an innovation of two engineers. Their control devices feature an impressive space-saving design – they can be folded together using origami techniques.

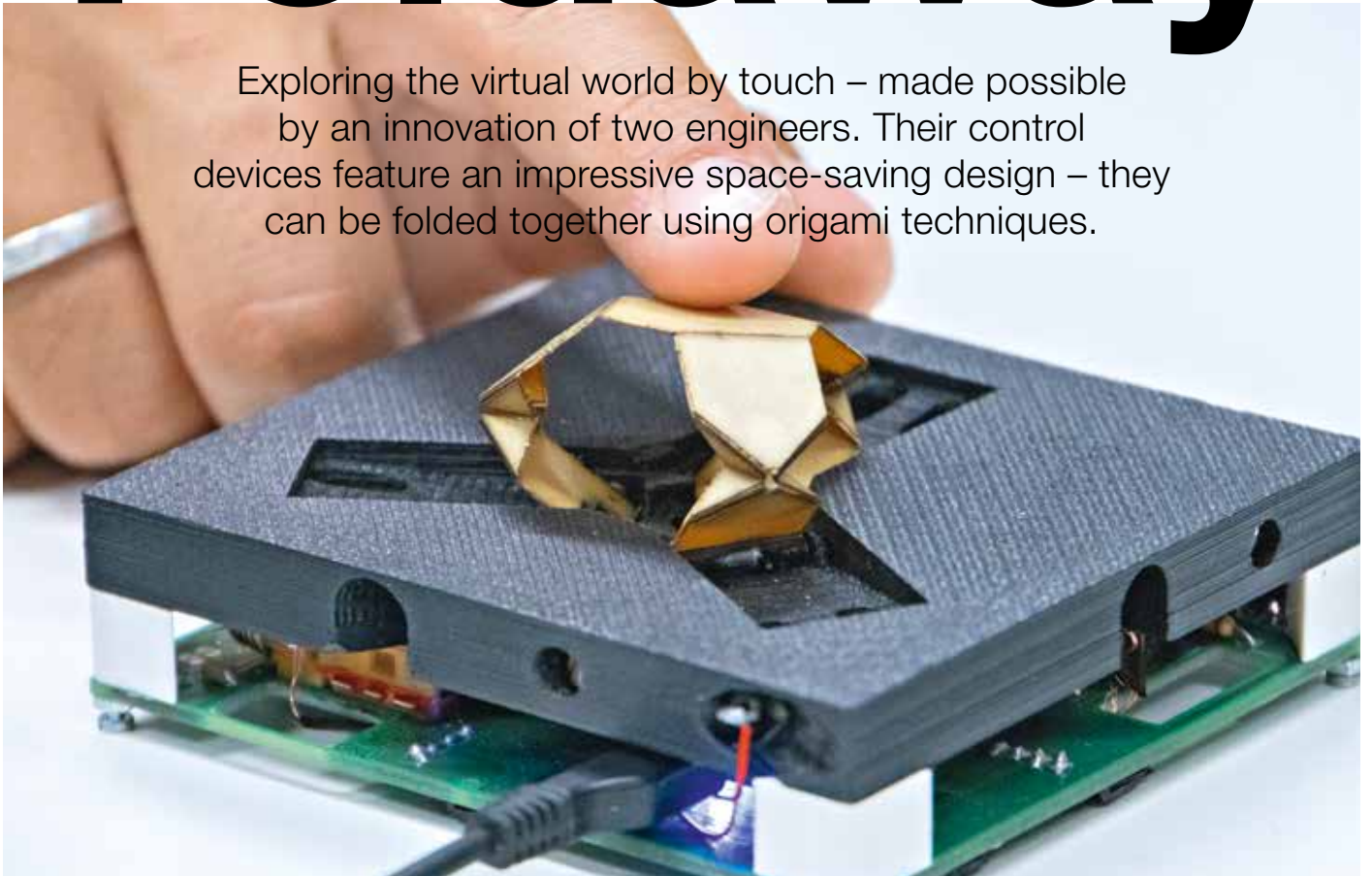

In the world of technology, moving components and joints are realized in a wide variety of ways. Motors and gearheads, for example, use ball bearings and gears. In household products, hinges and screw joints are commonplace. Two young engineers from the Swiss Federal Institute of Technology in Lausanne (EPFL) chose a rather unusual method for transferring motion – the art of folding.

In fact, their delicate control devices look like a mix of origami and electronics. “Foldaway” is the name they gave to these interfaces. The principle is similar to a notebook’s trackpoint – the little knob in the middle of the keyboard that is used to control the mouse pointer with the tip of your finger. Like a mouse or joystick, a Foldaway device is a controller. However, it can do a lot more.

Engineers Marco Salerno (left) and Stefano Mintchev.



“Portable haptic interface” – this is how Stefano Mintchev and Marco Salerno describe their development, which they plan to distribute through their start-up, “Foldaway Haptics”. The two keywords are portable and haptic. The origami technology makes the interface portable. The mini joystick, which is made of carbon fiber or other composite materials, can be folded away for easy storage inside the housing. “Haptic” describes device’s capability of giving touch feedback to its user. The basic principle is similar to a game controller’s vibration function. But, in addition to vibrations, Foldaway interfaces can apply forces under the fingers of the users. However, why is this useful?

In their office at the EPFL, Stefano Mintchev and Marco Salerno give a practical demonstration. The computer screen shows an anatomical image of a human torso. With a Foldaway interface, the user can now move the mouse pointer over the image. The trick is that the stiffness of the interface changes depending on the position of the mouse pointer. For example, if you move over a rib, you can no longer press the interface down. However, if you move over soft tissue, the interface yields under the pressure of the finger. Three tiny DCX motors by maxon handle the power transmission inside the device. The Swiss drive specialist supports the Foldaway project within the scope of its Young Engineers Program.

“In future, the interaction between humans and machines will become increasingly important and complex,” says Stefano Mintchev. The sense of touch will play a central role. Controllers with haptic feedback are nothing new on the market. What makes the Foldaway interfaces so special is their compact design and low weight. The flat control units easily fit into your pocket and connect to a computer or smartphone. Marco Salerno points out that the force feedback controllers currently on the market are expensive, relatively large, and cumbersome to transport. While there are some smaller controllers, these are usually limited to basic vibration feedback.

The two engineers have concrete plans for how their devices could be used in the future – for example by professional drone pilots. If the drone gets caught in a strong gust of wind, this force can be felt directly at the controller. The pilot gets a clear sense of the forces acting on the drone without having to rely on visual information alone. Virtual reality applications are an-

**“The interaction between humans and machines will become increasingly important and complex.”**



Stefano Mintchev, co-founder of “Foldaway Haptics”

other field where Stefano Mintchev and Marco Salerno see great potential for their controllers.

The special manufacturing process, in which thin layers of different materials are combined, makes it possible to produce the system in different shapes and sizes. “Since the assembly is automated, the units will be easy to mass-produce, which is going to keep the cost low,” says Stefano Mintchev. The small controllers already got the attention of a wider audience: In March 2018, the company won the Best Demonstration Award for one of their controllers at the IEEE Haptics Symposium in San Francisco. ■

## Young Engineers Program

maxon motor’s Young Engineers Program (YEP) supports innovative projects with discounted drive systems and technical advice.



Apply now:

[www.drive.tech](http://www.drive.tech)



# Sensorless control of brushless motors

Many applications would benefit from a brushless motor without a sensor. There are various options for realizing this. A method developed by maxon is now setting new standards for precision and reliability.



Urs Kafader, head  
of technical training,  
maxon motor

**D** riving a brushless motor requires control electronics for precise commutation. However, this is possible only if the control electronics “know” the exact position of the rotor at all times. Traditionally, this information was provided by sensors, e.g. Hall sensors, installed inside the motor. But it can be done differently. Sensorless control methods use current and voltage information from the motor to determine the rotor position. The motor speed can then be derived from changes in the rotor position, and this information can be used for speed control. More advanced sensorless control methods can even control the current (torque) and the position. Leaving out the sensors has a range of benefits, such a lower cost and space savings, because cables, connectors, and sensitive electronic circuits become unnecessary. Sensorless controllers by maxon use three basic principles that are adapted specifically to maxon BLDC motors.

**Principle 1: EMF method with zero crossing**

The EMF method with determination of the zero crossing uses induced voltage (or EMF) in the non-powered phase during block commutation. The zero crossing happens in the middle of the commutation interval (fig. 1). The time delay to the next commutation point can be estimated from the preceding commutation steps.

The EMF method with zero crossing works only when the speed is high enough, because EMF becomes zero at standstill. Starting up the motor requires a special

process, similar to step motor control, and must be configured separately. True sensorless commutation is possible only with motor speeds of 500–1000 rpm and up. The commutation step frequency is used for speed control. The limited feedback information puts some constraints on the motor dynamics, although this can be improved by integrating estimation methods into the control algorithm (observer, Kalman filter, etc.). The EMF method with zero crossing also has a range of benefits: It works for all brushless motor models, and it’s robust and cost-effective. The approach is used in many standard products, such as the maxon ESCON Module 50/4 EC-S.

**Principle 2: Observer-based EMF method**

Observer or model-based EMF methods use information about the motor current to determine rotor

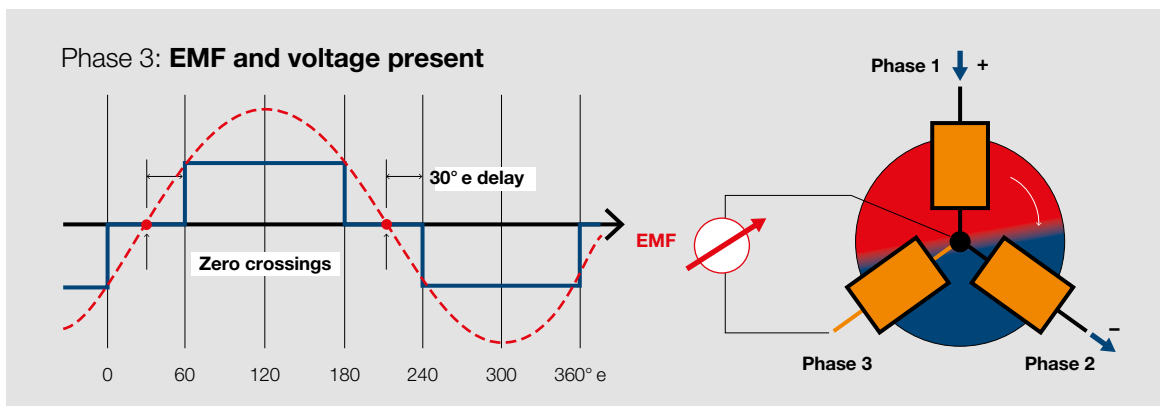

Figure 1: Schematic illustration of sensorless commutation of the EMF method with zero crossing, shown here using phase 3 as example.



position and speed. The model-based approach yields a much higher resolution of the rotor position. This enables sinusoidal commutation (or FOC, field-oriented control), with all its benefits: Higher efficiency, lower heat generation, less vibration and noise. However, the observer-based EMF method also requires a minimum speed of several 100 rpm to function properly.

**Principle 3: Magnetic anisotropy methods**

Methods based on magnetic anisotropy deduce the rotor position from the motor inductance, which is minimal when the magnetic flows of the rotor and the stator are in parallel in the magnetic return (fig. 2). Measurement is achieved by means of brief current pulses, which do not cause the motor to move. Unlike EMF-based methods, this method also works at stand-still or very low speeds, and it permits sinusoidal commutation. The measured signals are highly dependent on the motor type. The rotor position is determined in a model of the motor, which needs to be parameterized and adapted for each motor. Controllers based on magnetic anisotropy are therefore highly specific products – “plug and play” is not an option. The computation effort required for evaluating the rotor position also limits the maximum speed.

**Why sensorless control?**

In price-sensitive applications, the use of sensorless motors may reduce the cost. Hall sensors, encoders, cables, and connectors become unnecessary. Typical applications in this field are fans, pumps, scanners, mills, drills,

and other fast-turning applications with a relatively modest control performance that do not require a tightly controlled start-up. For high quantities, a customized version of the EMF-based controller makes sense.

**Cost optimization for high control performance**

Cost savings aren't the only reason to choose sensorless control. Applications like door drives or bike drives require high controller performance. Jerk-free motor control from zero rpm is important, as are high dynamics and sinusoidal commutation for noise avoidance. All this needs to be realized without using an expensive encoder. Over the last few years, high-quality sensorless controllers based on the anisotropy method have become established, including maxon's new High Performance Sensorless Control (HPSC, see box).

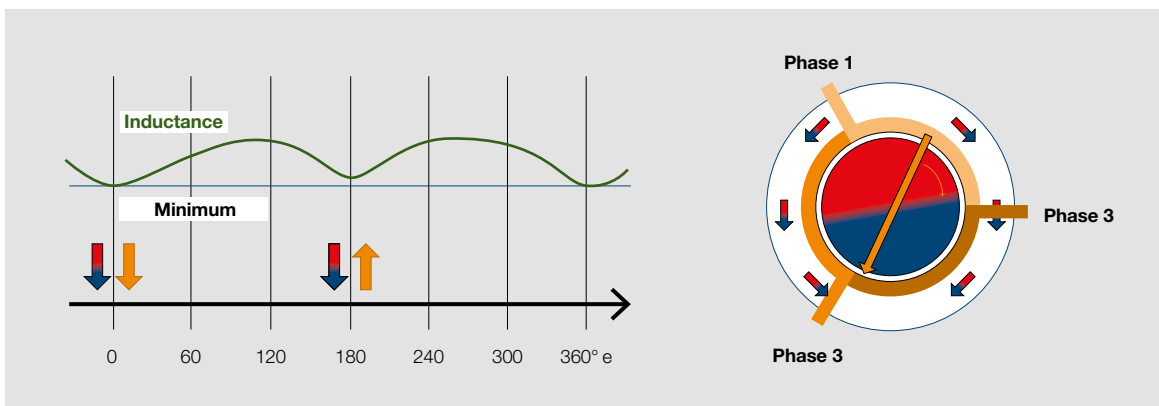

Figure 2: Schematic diagram of the anisotropy of inductance. It shows two almost identical minimums at a distance of 180 electrical degrees.

However, the engineering effort required for adapting the model parameters can only be justified for quantities upward of a few hundred.

### Rough ambient conditions

Sensorless control may also be required in situations where vulnerable sensor electronics need to be avoided in a motor. Examples include applications in very high or low ambient temperatures, cleaning and sterilization in medical technology, or ionizing radiation in space, nuclear facilities, or medical settings. The lower number of motor connectors also makes integration easier if space is limited.

The required control quality depends on the application. Which sensorless method fits best must be decided on a case by case basis. For example, hand-held dental tools for drilling or grinding need high speeds, while lower speeds and controlled torque are required for fixing screws in surgery.

### Conclusion

There are three main reasons for choosing sensorless control: Cost savings, space savings, and operation in environments unfavorable to sensors. The EMF method with zero crossing determination is widespread in cost-sensitive applications that run at high speeds. Sensorless control from standstill and at low speeds requires more advanced methods. The implementation effort is greater and includes modeling and parameterization. Cost savings are secondary. Field-oriented control yields a higher efficiency, less heat build-up, and a lower vibration and noise level. All these are advantages that come to bear especially in hand-held medical devices. ■

## maxon sensorless controllers

—The HPSC Module 24/5 (High Performance Sensorless Control) is a new development from maxon, it is a platform of hardware and customer-specific software. HPSC is always a customized solution and therefore not a catalog product. What's special about this development: At standstill and at low speeds, magnetic anisotropy-based control technology is used first (principle 3). Then, when the speed is higher, a smooth transition to an observer-based EMF method (principle 2) follows. The module's firmware is customized for every drive system. In a special tuning process, more than 120 parameters are automatically adjusted to each motor's "fingerprint." An example of the use of HPSC is the hand-held medical tool developed recently by maxon.



—The ESCON Module 50/4 EC-S is the only sensorless controller from maxon that is listed in the product catalog (block commutation with EMF method and zero crossing determination). The Sensorless Controller 24/1 is an alternative for the smallest EC motors (up to about 10mm diameter). However, it is not listed in the catalog or the e-shop.



# Keeping blood under control

Medical technology requires devices and drives with 100 percent reliability. Insulin pumps made by Ypsomed use only top-quality components.

**I**t's just a little black box that fits in any pocket, but it contains technology at the highest level: The insulin pump by the Swiss manufacturer Ypsomed, a company with the mission to make the life of diabetics easier. On demand, the YpsoPump – that's the device's name – injects a precisely defined amount of insulin into the patient's subcutaneous fatty tissue through a thin needle. The benefit: Diabetics no longer need to inject themselves several times daily, but only change the hose with the needle every few days. Changing the



battery and the insulin flask inside the device is also extremely easy. At a little under 80 grams, the pump is lighter than any mobile phone. Speaking of smartphones: Via Bluetooth, the pump even communicates with a notebook or phone to display vital statistics.

The pump itself has a touchscreen and can be used intuitively. The YpsoPump is especially suitable for patients with type-1 diabetes who require a continuous, reliable supply of insulin and need to balance every meal with additional insulin. "Simplicity of operation

## Pump helps patients with type-1 diabetes

The sugar content in our blood always changes. In a healthy body, the pancreas produces insulin as needed. Insulin is a hormone which ensures that glucose – i.e. sugar – can be absorbed by the cells and that blood sugar levels do not become excessively high. In diabetics, the pancreas produces no or too little insulin. This is why diabetics need to obtain the vital hormone externally – via syringes or special pump systems like the YpsoPump. This applies mainly to type-1 diabetics, who constitute a minority of diabetes patients. Type-1 diabetes is an autoimmune disorder with no known cure to date. About 90 percent of diabetics have type-2 diabetes, however. This type of diabetes occurs mainly in older and overweight people. A healthy diet and ample exercise are usually sufficient to keep type-2 diabetes under control or even prevent it, with no need for insulin injections.



and the use of latest technologies were our main goals in the development of the YpsoPump,” says Thomas Zeltner, product manager at the Burgdorf-based company. “Feedback from patients shows us that we’re on the right track.” The product portfolio of Ypsomed also includes blood sugar measuring systems, pen needles, as well as other equipment and services that make the lives of diabetics easier.

### maxon as a quality feature

The pump consists of about 50 parts and is produced in Switzerland. “We make the plastic parts in-house by injection molding.” maxon is a key supplier. The pump’s drive module uses slightly modified EC 9.2 flat motors, which drives a small threaded rod. A plunger at the end of the rod pushes the liquid from the flask into the hose that leads into the patient’s body. In this regard, the injection system is very similar to the mechanism of a common syringe. However, the insulin delivery needs to be extremely precise, which is why the pump requires a high-precision drive. “The maxon motor is a key component of our insulin pump,” Thomas Zeltner

says. “Apart from maxon, there are hardly any vendors that manufacture with a precision that is sufficient for medical applications.”

In the pump’s marketing, the name maxon motor is more than a side note. “We don’t simply use any little motor, but high-quality drives by the Swiss manufacturer maxon. We keep making this point to patients and visitors to our company,” Thomas Zeltner explains. Especially in medical technology, the label “Made in Switzerland” is important to ensure the trust of customers and patients alike.

The strong partnership between Ypsomed and maxon is an alliance for the future: According to Zeltner, production quantities of the YpsoPump are set to rise sharply in the coming years. ■



# Germ-free relief

Author: Stefan Roschi



Airplane lavatories are a flying horror. The cubicles are so tight that you can barely turn around, and every time you touch something with your hand, it comes with a slight sense of revulsion when you think of all the other passengers that have been here and left their signatures. For this reason, some people reduce their fluid intake before and during a flight in order to avoid having to go to the bathroom. And when they do go, they reach for the bottle of disinfectant immediately after.

## **The good news: There is hope for people with mysophobia**

In the coming years, we may expect self-cleaning airplane lavatories that require virtually no manual action of any kind. The actual timeline is still an open question though. Aviation manufacturer Boeing first presented an antiseptic lavatory two years ago. The prototype uses UV light after each use to literally explode germs (over 99 percent). However, if you are looking forward to a combination of lavatory and tanning studio then you're in for a disappointment: According to Boeing, the explosive light has no impact on humans.

The touchless functions are useful when it comes to flushing and using the soap dispenser or the waste bin. In the future, a wave of the hand in front of a sensor is enough to send a signal to the actuators, which then do their job. Several vendors of airplane lavatories are currently testing such systems, which frequently contain maxon drives. Well, great, you might hear some women say. What if there are still men who go about their business standing up, with maybe less than perfect aim? And during turbulence? Have no fear, there appears to be a solution in sight. One manufacturer recently suggested replacing one of the lavatory cabins with two urinals. This would also shorten the annoying queues during flights. In a word, the future of the restroom above the clouds isn't looking so bad. We are relieved! That said, until the above becomes reality, we continue to keep a disinfectant bottle in our carry-on. ■■■

## Contest

### Contest

# What is the approximate number of products in the maxon online shop?

- a) 500
- b) 5,000
- c) 50,000

Prizes are three vouchers for orders in the maxon online shop. 1<sup>st</sup> prize: 30 percent discount, 2<sup>nd</sup> prize: 10 percent discount, 3<sup>rd</sup> prize: 5 percent discount

Simply e-mail your answer to [driven@maxonmotor.com](mailto:driven@maxonmotor.com)

The deadline for participation is February 28, 2019

Winners will be notified. Employees of maxon motor are not eligible to participate. There will not be any correspondence in regard to the contest. All decisions are final. The data disclosed to us as part of this competition will be used exclusively for the draw and the notification of the winners and then deleted.

[www.drive.tech](http://www.drive.tech)

## Why don't you take a look at our blog?

The maxon corporate blog [www.drive.tech](http://www.drive.tech) has many exciting reports, videos, and technical articles in which maxon experts offer their knowledge. Let yourself be excited, learn new things, and discuss with our bloggers.



For example, take this article by motion control specialist Jürgen Wagenbach:

Expert blog

## Is there a maximum length for encoder cables?

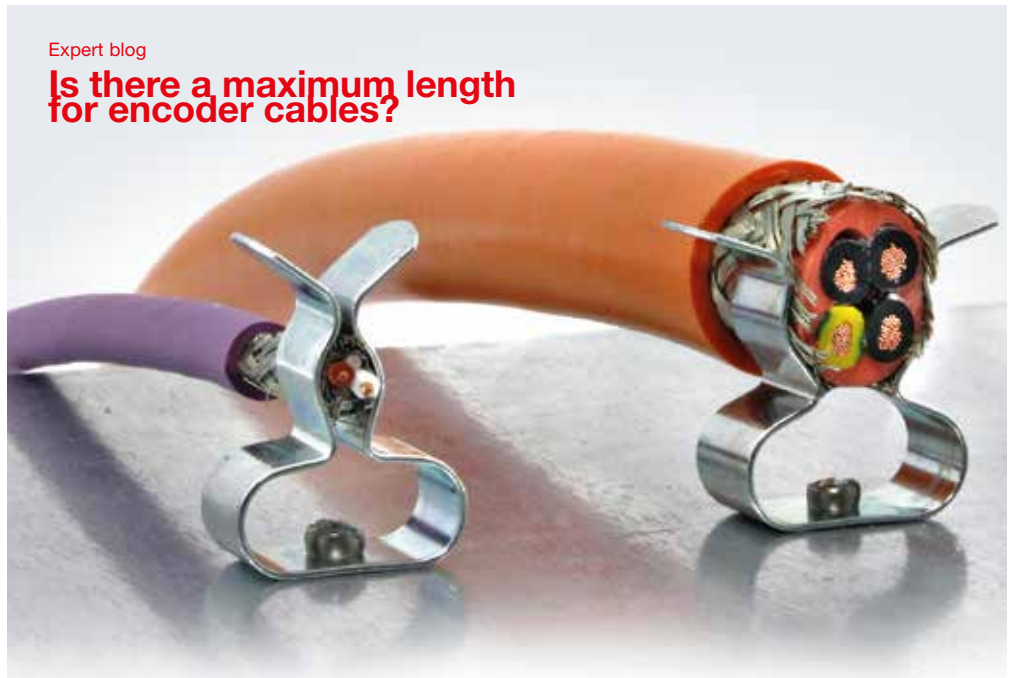



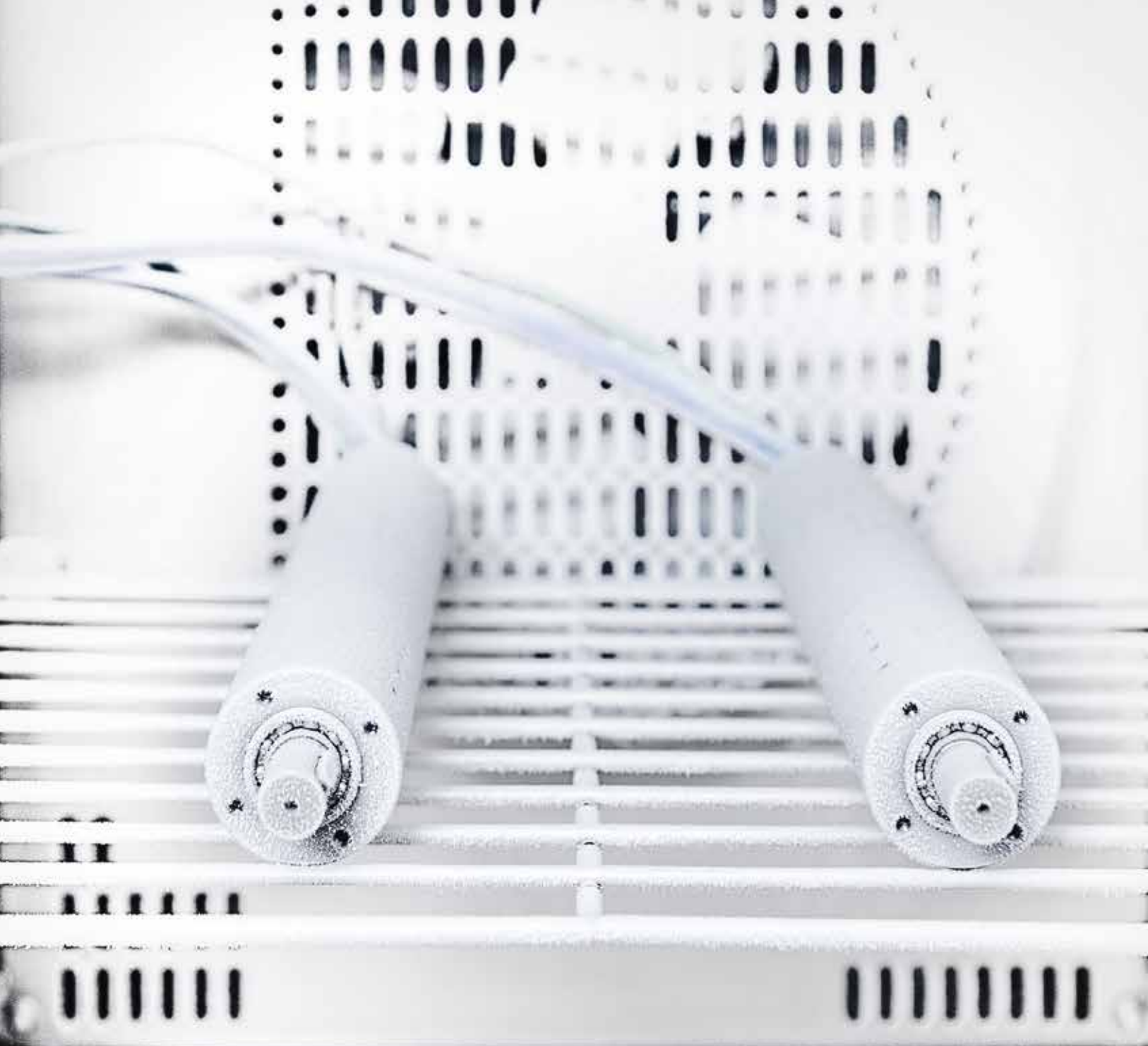

## The ice skaters

**These heavy duty (HD) brushless (EC) motors are engineered to withstand icy cold conditions. To do this, maxon engineers subject them to extreme temperatures inside the test cabinet. Temperatures as low as  $-130^{\circ}\text{C}$  can be simulated. However, the drives only appear so wonderfully white if the cabinet door is opened during the test.**